



SOURCE1

HVAC Service Parts



26TH EDITION

EFFECTIVE APRIL 2019

PRODUCT CATALOG

A TOOL
AS VALUABLE
AS YOUR TIME.



Welcome to HVAC Navigator... You've come to the right place.



HVAC Navigator is your single sign-on, one stop for everything HVACR. As leaders in the industry, we can offer you cutting-edge tools, allowing you to get the job done.



Part Navigator is a powerful solution which enables you to access service parts information (searchable by model, serial number or by attribute) timely and accurately. Parts Navigator provides parts lists and interactive exploded drawings of the equipment to enable users to quickly identify the part they need.



With HVAC Navigator, you'll receive product family icon navigation, top level assembly (serial number) and hot-spotting illustrations and enhanced search capabilities. Download your cart and order your parts ALL through the same site.

Visit HVACNavigator.com today!

HVAC Navigator is mobile-friendly...so you can use your tablet on the road and find the parts you need.

TABLE OF CONTENTS

CATEGORIZED LISTING

REFRIGERATION & AIR CONDITIONING

Compressors	1
Compressor Sound Blankets	12

AIR CONDITIONING & HEATING CONTROLS

Thermostats and Thermostat Accessories	13
Sight Glasses & Moisture Indicators	19
Driers	19
Filters	23
Thermostatic Expansion Valves	23
Solenoid Valves And Coils	25
Refrigeration Ball Valves	27
Gas Heating Controls	27
Gas Valves	27
Power Generators, Thermocouples, Hot Surface Igniters, Flame Sensors	32
Ignition Modules & Integrated Furnace Controls	36
Fan & Limit Controls	49
Electric Heating Controls	50
Oil Heating Controls	50
Hydronic Heating Controls & Gas Water Heater Valves	54
Contactors	55
Condensation Controls & Compressor Protection Modules	56
Hard Start Devices	57
Freeze Protection & Defrost Controls	58
Motor Protection	60
Relays	61
Fan Blower Controls & Fan Control Centers	69
Head Pressure Controls	71
Enclosure	72
Line Monitors	73
Transformers	79

VENTILATION & INDOOR AIR QUALITY

Indoor Air Quality	81
Residential Air Filtration Systems	81
High Efficiency Media Air Cleaners	82
Residential Air Purifiers	84
Residential Humidifiers	84
Residential Dehumidifiers	85
Recovery Ventilators	85
Smoke & Gas Detectors	86
Zoning, Venting & Economizer Controls	88
Control Panels	89
Zoning Accessories & Dampers	89
Zoning Dampers	91
By-Pass Dampers	94
Temperature And Outdoor Air Sensors	95
Damper Actuators	96
Proportional Motors	98

MOTORS & MOTOR ACCESSORIES

Source 1 Motors	99
High-Ambient Condenser Fan Motors	99
Single Horsepower Condenser Fan Motors	100
Single Horsepower Blower Motors	100
Timesaver Multi-HP PSC Motors	101
Direct Drive Blower Motors	103
Century Electric Blower Motors	108
Genteq Motors	109
Fasco Motors	110
Motor Speed Controls	111
Capacitors	112
Fan Blades	117
Blower Wheels	116
2-Blade Propellers	117
3-Blade Propellers	117
4-Blade Propellers	119
Blower Assemblies	123
Blower Parts & Accessories	127
Bearings	128
Mounting Brackets	129
Sheaves	130
Bushings	135
V-Belts	136

INSTALLATION AND MAINTENANCE SUPPLIES

Installation Accessories	143
Gas Accessories	143
Mounting Accessories	147
Sealant	148
Touch-Up Paints	148

ELECTRICAL ACCESSORIES

Slip-On Terminals	149
Spade Terminals	149
Tab Adapter Terminals	149
Disconnects	150
Disconnect Terminals	150
Wire Connectors	151
Circuit Breakers	151
Fuses	152

TEST INSTRUMENTS AND TOOLS

Temperature and Pressure Sensors	155
Diagnostic Devices	155
Amp Extraction Tools	155
Acid Test Kits	155

NOTES

REFRIGERATION &
AIR CONDITIONING

AIR CONDITIONING &
HEATING CONTROLS

VENTILATION AND
INDOOR AIR QUALITY

MOTORS &
MOTOR ACCESSORIES

INSTALLATION
SUPPLIES

ELECTRICAL
ACCESSORIES

TEST INSTRUMENTS
& TOOLS

INDEX

Compressors

COPELAND A/C SCROLL MODELS

Compressor Family Series
Either a number or a letter established for each product model

Modulation
D - Digital
DU - Digital Uneven Tandem
DT - Digital Even Tandem
S - Two Step
T - Even Tandem
U - Uneven Tandem
V - Variable Speed

Phase	Description	Code
1	Capacitor Run - Permanent Split Capacitor	P
3	General 3 Lead Single Voltage 6 Lead Part Winding (575 Volt)	T

Product Variations

- 130 indicates a standard compressor and component parts with molded plug connection.
- 230 indicates a standard compressor and component parts with quick connect terminal.
- 250 indicates a standard compressor and component parts with screw on terminals.
- 260 indicates standard compressor and component parts with quick connect terminal and rotalock valves.
- 700, 900 series indicates standard OEM and wholesaler service.
- Other numbers designate variations

E - 3MA POE Oil

Compressor nominal capacity at rating conditions to two significant digits.

X X X X X X X X - X X X - X X X

Capacity Multiplier
K: 1,000
M: 10,000

Electrical Codes		
60 Hz.	50 Hz.	Code
208/230-3	200-3	C
460-3	380/420-3	D
575-3	-	E
265-1	220/240-1	J
-	220/240-3	R
208/230-1	-	V
200/230-3	200/220-3	5
380-3	-	7
	380-3	P
	220/240-1	Z

Application Range		
Code	Refrig	Description
P	R-410A	High Temperature Ultra High Temperature
R	R-22/407C/134A	High Temperature
Z	R-22	High Temperature Tandem Configuration

Model Variation
A number or a letter, assigned to indicate different model types within any one family series

Compressor Motor Protection	
Type Protection	Code
<i>Internal Inherent Protection -</i> One Protector Use with Contactor (Single or three Phase)	F
<i>External Electronic Protection -</i> Kriwan Module (Three Phase)	W

Compressors

COPELAND CRKQ, CIKQ MODELS

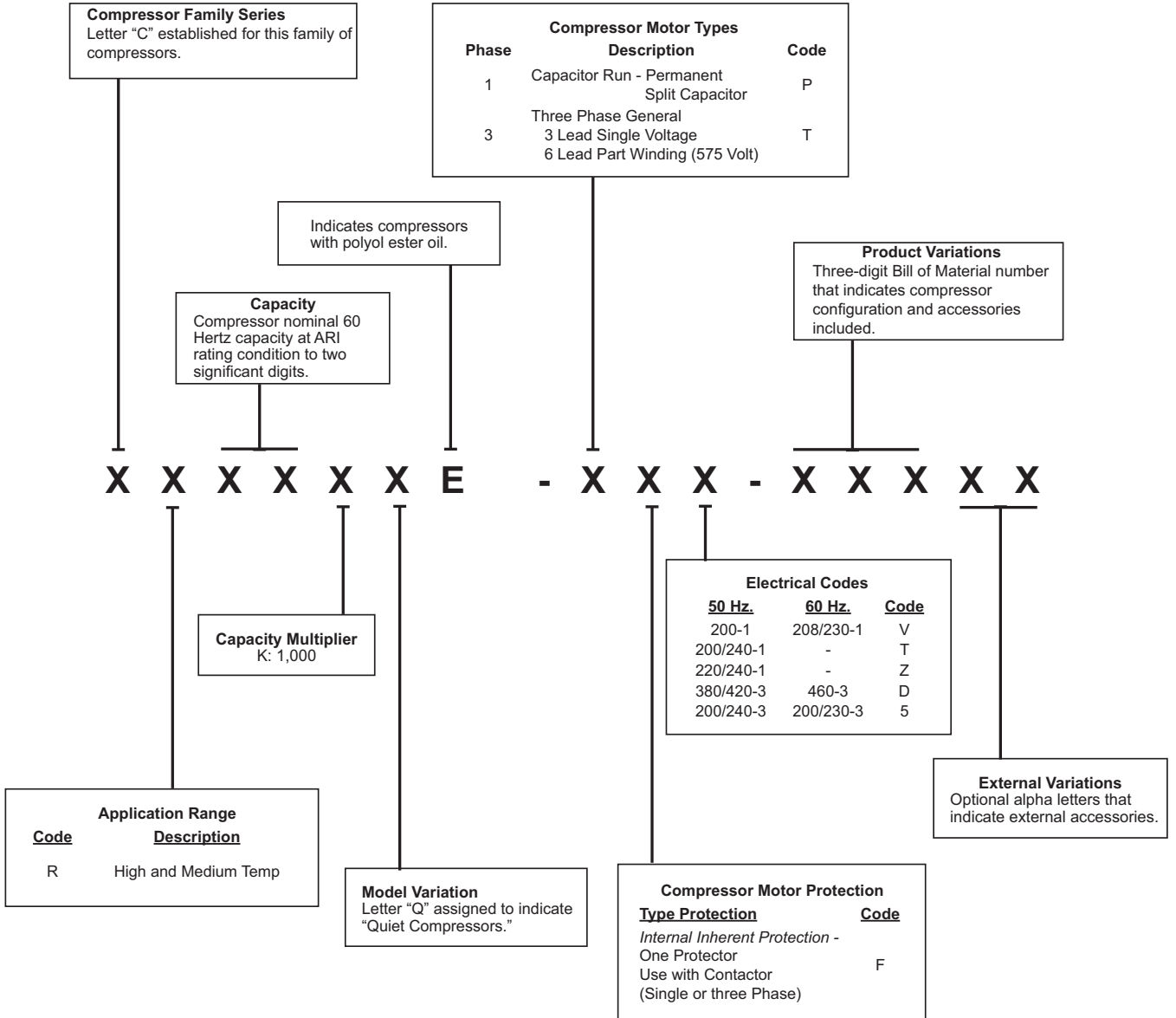

Compressors

COPELAND CR7, CR6, CRKF, CS, CF MODELS

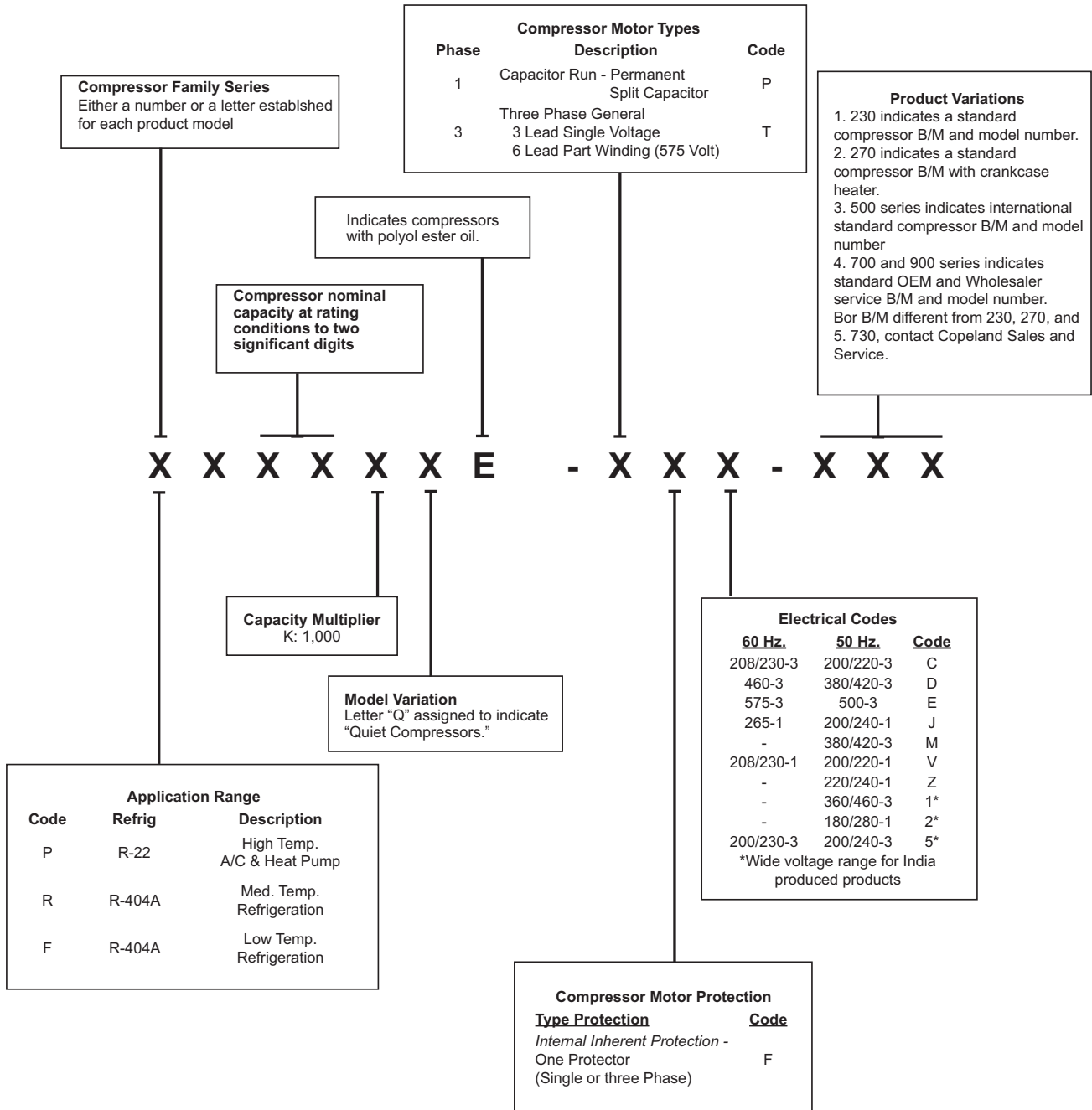

Compressors

COPELAND RECIPROCATING COMPRESSORS

CR5 Series

For Air Conditioning & Heat Pump Application



Features:

- Internal line break motor protection
- Baked enamel finish
- Low vibration & noise
- Centrifugal oil pump
- High efficiency - 10.3 EER
- Refrigerant - HCFC-22
- Foot print - 7.5 x 7.5
- Quick connect wire connections
- Suitable for 50 Hz. operation

SOURCE 1 PART NO.	COPELAND MODEL / B/M NO.	CAPACITY BTUH	V-PH-HZ	RLA	LRA	EER	SUCTION		DISCH ID (IN)	OVERALL HT (H) (IN)	CCH	*RUN CAP	SHIP WT. (LBS.)	MLP
							ID	HT (S)						
S1-CRNQ-050EPFV970	CRNQ-050E-PFV970	62,700	208/230-1-60	34.3	142.0	10.3	7/8	16.0	1/2	16.5	YES	55/440	88	2065.26
S1-CRNQ-050ETF5970	CRNQ-050E-TF5-970	57,000	200/230-3-60	19.2	130	9.8	7/8	15.29	1/2	16.13			90	2385.32
S1-CRNQ-050ETFD970	CRNQ-050E-TFD-970	57,000	460-3-60	8.7	65	9.8	7/8	15.29	1/2	16.13			82	2385.32
S1-CRPQ-045EPFV970	CRPQ-045E-PFV-970	54500	208/230-1-60	27.6	135	10	7/8	15.04	1/2	16.13			87	2165.97
S1-CRPQ-045ETF5970	CRPQ-045E-TF5-970	56500	200/230-3-60	17.6	105	9.8	7/8	15.04	1/2	16.13			82	2330.05
S1-CRPQ-045ETFD970	CRPQ-045E-TFD-970	56500	460-3-60	9.4	55	10	7/8	15.04	1/2	16.13			91	2285.24

* **NOTE:** When substituting compressors always check the capacitor MFD and voltage (when required) and replace if necessary. The capacitor **MUST** be the proper MFD and voltage for the compressor.

CR6 Series

For Air Conditioning & Heat Pump Application



Features:

- Internal line break motor protection
- Baked enamel finish
- Low vibration & noise
- Centrifugal oil pump
- High efficiency - up to 11.0
- Refrigerant - HCFC-22
- Foot print - 7.5 x 7.5
- Quick connect wire connections
- Suitable for 50 Hz. operation

SOURCE 1 PART NO.	COPELAND MODEL / B/M NO.	CAPACITY BTUH	V-PH-HZ	RLA	LRA	EER	SUCTION		DISCH ID (IN)	OVERALL HT (H) (IN)	CCH	*RUN CAP	SHIP WT. (LBS.)	MLP
							ID	HT (S)						
S1-CR16K6E-PFV-875	CR16K6E-PFV-875	16300	208/230-1-60	9.6	49	10.6	3/4 ID	11.26	1/2 ID	10.228	YES		61	1122.78
S1-CR18K6E-PFV-875	CR18K6E-PFV-875	18000	208/230-1-60	10.4	49	10.6	3/4	11.25	0.38	13.19	YES	25/370	61	1140.32
S1-CR20K6E-PFV-875	CR20K6E-PFV-875	19600	208/230-1-60	10.6	50	10.7	3/4	11.25	0.38	13.19	YES	45/440	61	1153.73
S1-CR22K6E-PFV-875	CR22K6E-PFV-875	19900	208/230-1-60	10.9	50	10.55	3/4	10.945	0.5	13.19	YES	30.0/370	63	1160.40
S1-CR24K6E-PFV-875	CR24K6E-PFV-875	24500	208/230-1-60	12.4	61	10.9	3/4 ID	11.51	1/2 ID	10.228	YES		63	1167.34
S1-CR28K6E-PFV-875	CR28K6E-PFV-875	28200	208/230-1-60	15.3	75	10.8	3/4 ID	11.63	1/2 ID	10.228	YES		64	1184.16
S1-CR30K6E-PFV-875	CR30K6E-PFV-875	30000	208/230-1-60	16	82	10.9	3/4 ID	11.88	1/2 ID	10.228	YES		66	1242.87
S1-CR32K6E-PFV-875	CR32K6E-PFV-875	32000	208/230-1-60	16.1	82	10.8	3/4 ID	11.88	1/2 ID	10.228	YES		66	1304.52
S1-CR32K6E-TF5-875	CR32K6E-TF5-875	31900	208/230-1-60	10	72	11	3/4 ID	11.88	1/2 ID	10.228	YES		63	1656.01
S1-CR32K6E-TFD-875	CR32K6E-TFD-875	31900	460-3-60	5.1	33	11	3/4	11.565	0.5	13.81	YES	25.0/370	63	1688.48
S1-CR32K6E-TFD-875	CR32K6E-TFD-875	29300	460-3-60	4.6	33	10.5	3/4 ID	11.56	1/2 ID	13.81			63	1688.48
S1-CR34K6E-PFV-875	CR34K6E-PFV-875	31200	208/230-1-60	16.6	96	10.6	3/4	11.565	0.5	14.06	YES	50.0/370	67	1308.72
S1-CR35K6E-PFV-875	CR35K6E-PFV-875	35000	208/230-1-60	18	96	10.9	3/4 ID	12.13	1/2 ID	10.228	YES		67	1315.17
S1-CR35K6E-TF5-875	CR35K6E-TF5-875	34900	230/200-3-60	11.4	75	11	3/4 ID	12.13	1/2 ID	10.228	YES	N/A	65	1691.26
S1-CR35K6E-TFD-875	CR35K6E-TFD-875	34900	460-3-60	4.8	41	11	3/4 ID	12.13	1/2 ID	10.228	YES	N/A	65	1691.26
S1-CR38K6E-PFV-875	CR38K6E-PFV-875	38200	208/230-1-60	19	105	10.9	3/4 ID	12.38	1/2 ID	10.228	YES		70	1323.57
S1-CR38K6E-TF5-875	CR38K6E-TF5-875	37900	230/200-3-60	11.9	85	11	3/4 ID	12.38	1/2 ID	10.228	YES	N/A	67	1728.00
S1-CR38K6E-TFD-875	CR38K6E-TFD-875	37900	460-3-60	5.9	42	11	3/4 ID	12.38	1/2 ID	10.228	YES	N/A	67	1778.74
S1-CR38K6E-TFE-875	CR38K6E-TFE-875	3500	575-3-60	4.3	34	10.6	3/4 ID	12.06	1/2 ID	14.31			67	1781.90
S1-CR42K6E-PFV-875	CR42K6E-PFV-875	41900	208/230-1-60	20.4	102	10.9	3/4 ID	12.63	1/2 ID	10.228	YES		74	1342.86
S1-CR42K6E-TF5-875	CR42K6E-TF5-875	41700	230/200-3-60	14	91	10.9	3/4 ID	12.63	1/2 ID	10.228	YES	N/A	69	1806.50
S1-CR42K6E-TFD-875	CR42K6E-TFD-875	39500	460-3-60	5.7	42	11.1	3/4 ID	12.31	1/2 ID	14.56			69	1806.50

* **NOTE:** When substituting compressors always check the capacitor MFD and voltage (when required) and replace if necessary. The capacitor **MUST** be the proper MFD and voltage for the compressor.

Compressors

COPELAND RECIPROCATING COMPRESSORS

CRKQ Series

For Air Conditioning & Heat Pump Application



Features:

- Internal line break motor protection
- Baked enamel finish
- Low vibration & noise
- Centrifugal oil pump
- Refrigerant - HCFC-22
- Foot print - 7.5 x 7.5
- Quick connect wire connections
- Suitable for 50 Hz. Operation, High efficiency - up to 10.4

SOURCE 1 PART NO.	COPELAND MODEL / B/M NO.	CAPACITY BTUH	V-PH-HZ	RLA	LRA	EER	SUCTION		DISCH ID (IN)	OVERALL HT (H) (IN)	CCH	*RUN CAP	SHIP WT. (LBS.)	MLP
							ID	HT (S)						
S1-CR18K6E-TF5-875	CR18K6E-TF5-875	18400	200/230-3-60	6.1	49	10.4	0.63	11.375	0.38	13.38	YES		61	1352.71
S1-CR18K6E-TFD-875	CR18K6E-TFD-875	23300	460-3-60	3.1	23	10.2	0.63	11.375	0.38	13.38	YES		61	1352.71
S1-CR24K6E-TF5-875	CR24K6E-TF5-875	23300	200/230-3-60	7.5	51	10.1	0.63	11.375	0.38	13.38	YES		60	1474.32
S1-CR24K6E-TFD-875	CR24K6E-TFD-875	23200	460-3-60	3.7	25	10.2	0.63	11.875	0.38	13.38	YES		60	1474.32
S1-CR28K6E-TF5-875	CR28K6E-TF5-875	27300	200/230-3-60	8.9	60.5	10.4	0.63	11.375	0.38	13.38	YES		59	1470.27
S1-CR28K6E-TFD-875	CR28K6E-TFD-875	27500	460-3-60	4.4	30	10.5	0.63	11.375	0.38	13.38	YES		59	1499.10
S1-CR47KQE-PFV-970	CR47KQE-PFV-970	47500	208/230-1-60	24.6	132	10.4	0.88	14.11-14.49	0.5	14.81	YES	45/440	77	1451.36
S1-CR47KQE-TF5-970	CR47KQE-TF5-970	47,200	230/200-3-60	16	97	10.4	7/8 ID	14.68	1/2 ID	10.375	YES		77	2046.06
S1-CR47KQE-TFD-970	CR47KQE-TFD-970	47,200	460-3-60	8.2	50	10.4	7/8 ID	14.68	1/2 ID	10.375	YES		77	2079.17
S1-CR53KQE-PFV-970	CR53KQE-PFV-970	53,300	208/230-1-60	29	140	10.1	7/8 ID	14.68	1/2 ID	10.375	YES		77	1829.20
S1-CR53KQE-TF5-970	CR53KQE-TF5-970	53,200	230/200-3-60	18	107	10.1	7/8 ID	14.68	1/2 ID	10.375	YES		77	2448.54
S1-CR53KQE-TFD-970	CR53KQE-TFD-970	53,200	460-3-60	9.1	55	10.2	7/8 ID	14.68	1/2 ID	10.375	YES		77	2448.54
S1-CR35K6E-PFV-875	CR35K6E-PFV-875	35000	208/230-1-60	18	96	10.9	3/4 ID	12.13	1/2 ID	10.228	YES		67	1315.17
S1-CR35K6E-TF5-875	CR35K6E-TF5-875	34900	230/200-3-60	11.4	75	11	3/4 ID	12.13	1/2 ID	10.228	YES	N/A	65	1691.26
S1-CR35K6E-TFD-875	CR35K6E-TFD-875	34900	460-3-60	4.8	41	11	3/4 ID	12.13	1/2 ID	10.228	YES	N/A	65	1691.26
S1-CR38K6E-PFV-875	CR38K6E-PFV-875	38200	208/230-1-60	19	105	10.9	3/4 ID	12.38	1/2 ID	10.228	YES		70	1323.57
S1-CR38K6E-TF5-875	CR38K6E-TF5-875	37900	230/200-3-60	11.9	85	11	3/4 ID	12.38	1/2 ID	10.228	YES	N/A	67	1728.00
S1-CR38K6E-TFD-875	CR38K6E-TFD-875	37900	460-3-60	5.9	42	11	3/4 ID	12.38	1/2 ID	10.228	YES	N/A	67	1778.74
S1-CR38K6E-TFE-875	CR38K6E-TFE-875	3500	575-3-60	4.3	34	10.6	3/4 ID	12.06	1/2 ID	14.31			67	1781.90
S1-CR42K6E-PFV-875	CR42K6E-PFV-875	41900	208/230-1-60	20.4	102	10.9	3/4 ID	12.63	1/2 ID	10.228	YES		74	1342.86
S1-CR42K6E-TF5-875	CR42K6E-TF5-875	41700	230/200-3-60	14	91	10.9	3/4 ID	12.63	1/2 ID	10.228	YES	N/A	69	1806.50
S1-CR42K6E-TFD-875	CR42K6E-TFD-875	39500	460-3-60	5.7	42	11.1	3/4 ID	12.31	1/2 ID	14.56			69	1806.50

* NOTE: When substituting compressors always check the capacitor MFD and voltage (when required) and replace if necessary. The capacitor MUST be the proper MFD and voltage for the compressor.

Compressors

COPELAND RECIPROCATING COMPRESSORS

ZP Series for R410A

For Air Conditioning & Heat Pump Application



Features:

- ZP Copeland Scroll compressors, for R410A, for comfort and process/precision cooling applications
- Copeland Scroll axial and radial compliance for superior reliability and efficiency
- Extended 5K operating envelope suitable for HP applications
- Low TEWI (Total Equivalent-Warming Impact)
- Low sounds and vibration level
- Low oil circulation rate

SOURCE 1 PART NO.	COPELAND MODEL / B/M NO.	CAPACITY BTUH	V-PH-HZ	RLA	LRA	ARI EER	SUCTION		OVALL HT (H)	COMP. DIAM.	*RUN CAP	WIRE CONN	SHIP WT. (LBS.)	MLP
							ID	HT (S)						
S1-ZP154KCE-TE5950	ZP154KCE-TE5-950	154000	200/230-3-60	57.1	300	11.1	1.375	5.53	22.21	9.14	N/A	052-2841-00	146	5144.01
S1-ZP154KCE-TED950	ZP154KCE-TED-950	155000	460-3-60	25.7	150	11.1	1.375	5.53	21.72	9.14	N/A	052-2841-00	143	5144.01
S1-ZP180KCE-TWC961	ZP180KCE-TWC-961	180000	208/230-3-60	59.1	425	11.2	2 1/4 RT	12.54	23.3	11.14	N/A	Screw	235	8122.14
S1-ZP180KCE-TWD961	ZP180KCE-TWD-961	180000	460-3-60	26.4	187	11.2	2 1/4 RT	12.54	23.3	11.14	N/A	Screw	235	6456.38
S1-ZP182KCE-TED950	ZP182KCE-TED-950	183000	460-3-60	30	173	11.2	1.375	5.53	21.72	9.14	N/A	052-2841-00	146	6217.04
S1-ZP385KCE-TED951	ZP385KCE-TED951	385000	460-3-60	60.7	310	11.1	1 5/8 S	14.77	28.5	13.03	N/A	Screw	390	16434.23
S1-ZP20K5E-PFV-800	ZP20K5E-PFV-800	20000	208/230-1-60	15.0	58.3	9.8	3/4 S	10.25	15.27	5.5	N/A	Molded Plug	47.4	1677.93
S1-ZP24K5E-PFV-800	ZP24K5E-PFV-800	24000	208/230-1-60	14.3	64.0	10.0	3/4 S	10.25	15.27	5.5	N/A	Molded Plug	48.3	1677.93
S1-ZP31K5E-PFV-800	ZP31K5E-PFV-800	31100	208/230-1-60	18.6	79.0	10.1	3/4 S	10.25	15.27	5.5	N/A	Molded Plug	49.6	1677.93
S1-ZP34K5E-PFV-800	ZP34K5E-PFV-800	34500	208/230-1-60	17.9	112.0	10.2	7/8 S	11.50	16.94	6.58	N/A	Molded Plug	71.2	1677.93
S1-ZP36K5E-PFV-830	ZP36K5E-PFV-830	36000	208/230-1-60	20	112	10.2	7/8 S	11.61	19.94	6.58	N/A	Molded Plug	71.2	1677.93
S1-ZP36K5E-TF5-830	ZP36K5E-TF5-830	36000	200/230-3-60	15.1	88	10.3	7/8 S	11.61	19.94	6.58	N/A	Molded Plug	63.7	1934.50
S1-ZP38K5E-PFV-800	ZP38K5E-PFV-800	37500	208/230-1-60	22.1	109.0	10.1	7/8 S	11.50	16.94	6.58	N/A	Molded Plug	72.0	1677.93
S1-ZP42K5E-TF5-800	ZP42K5E-TF5-800	41900	460-3-60	15.6	83.1	10.5	7/8 S	11.40	16.5	6.5	N/A	Molded Plug	67.0	1978.20
S1-ZP42K5E-PFV-800	ZP42K5E-PFV-800	42000	208/230-1-60	24.3	117.0	10.3	7/8 S	11.50	16.94	6.58	N/A	Molded Plug	72.9	1677.93
S1-ZP49K5E-PFV-800	ZP49K5E-PFV-800	49400	208/230-1-60	27.9	134.0	10.6	7/8 S	11.50	16.94	6.58	N/A	Molded Plug	75.8	1677.93
S1-ZP54K5E-PFV-800	ZP54K5E-PFV-800	54000	208/230-1-60	29.3	134.0	10.5	7/8 S	11.50	16.94	6.58	N/A	Molded Plug	75.6	1677.93
S1-ZP57K3E-PFV-930	ZP57K3E-PFV-930	57000	208/230-1-60	33.6	158	10.1	7/8 S	11.73	17.91	7.3	N/A	Quick Connect	98	2561.76
S1-ZP57K3E-TF5-930	ZP57K3E-TF5-930	58000	200/230-3-60	22.9	155	10.6	7/8 S	11.73	17.91	7.3	N/A	Quick Connect	92	2737.79
S1-ZP57K3E-TFD-930	ZP57K3E-TFD-930	58000	460-3-60	10.7	75	10.6	7/8 S	11.73	17.91	7.3	N/A	Quick Connect	92	2737.79
S1-ZP61K5E-PFV-800	ZP61K5E-PFV-800	61500	208/230-1-60	34.3	178	10.5	7/8 S	11.61	17.36	6.58	N/A	Molded Plug	77.2	2661.06
S1-ZP61K5E-TFD-800	ZP61K5E-TFD-800	61500	460-3-60	9.1	66.1	10.7	7/8 S	11.61	17.5	6.58	N/A	Molded Plug	77.2	2903.60
S1-ZP61KCE-TF5-830	ZP61KCE-TF5-830	61500	200/230-3-60	21.2	123	10.8	7/8 S	11.73	17.91	7.3	N/A	Molded Plug	88.8	2735.54
S1-ZP67KCE-TF5-950	ZP67KCE-TF5-950	67500	200/230-3-60	25	149	10.8	7/8 S	11.73	17.91	7.3	N/A	Screw	88	2935.61
S1-ZP67KCE-TFD-950	ZP67KCE-TFD-950	67000	460-3-60	11.8	75	10.8	7/8 S	11.73	17.91	7.3	N/A	Screw	88	2935.61
S1-ZP72KCE-TF5-950	ZP72KCE-TF5-950	72000	200/230-3-60	25.9	164	10.7	7/8 S	11.73	17.91	7.3	N/A	Screw	88	3213.62
S1-ZP90KCE-TF5-950	ZP90KCE-TF5-950	90500	200/230-3-60	32.9	195	10.8	1.125	3.69	18.75	9.14	N/A	Screw	127	4664.90
S1-ZP90KCE-TFD-950	ZP90KCE-TFD-950	90500	460-3-60	16.4	95	10.8	1.125	3.69	18.75	9.14	N/A	Screw	127	4664.90

* **NOTE:** When substituting compressors always check the capacitor MFD and voltage (when required) and replace if necessary. The capacitor **MUST** be the proper MFD and voltage for the compressor.

Compressors

COPELAND SCROLL COMPRESSORS

ZR16K THRU ZR300K

For Air Conditioning & Heat Pump Application

SOURCE 1 PART NO.	COPELAND MODEL / B/M NO.	CAPACITY BTUH	V-PH-HZ	RLA	LRA	ARI EER	SUCTION		DISCH HT (D)	OVALL HT (H)	COMP. DIAM.	*RUN CAP	WIRE CONN.	SHIP WT. (LBS.)	MLP
							ID	HT (S)							
S1-ZRT144KCE-TF7-930	ZRT144KCE-TF7-930	144000	380-3-60	10.2	70	11.4	1.125	11.68	17.49	18.8	7.3	N/A	005-0860-00	205	6136.16
S1-ZRT144KCE-TFD-930	ZRT144KCE-TFD-930	144000	460-3-60	10	75	11.4	1.125	11.68	17.49	18.8	7.3	N/A	005-0860-00	205	6550.75
S1-ZRT144KCE-TFE-930	ZRT144KCE-TFE-930	144000	575-3-60	8.2	54	11.4	1.125	11.68	17.49	18.8	7.3	N/A	005-0860-00	205	6620.31
S1-ZRT162KCE-TFD-930	ZRT162KCE-TFD-930	135000	380/420-3-50	12.1	101	11.3	1.125	11.69	17.49	19.02	7.3	N/A	052-0880-00	205	10749.84
S1-ZRT188KCE-TFE-950	ZRT188KCE-TFE-950	191500	575-3-60	12	80	11.6	1.625	3.69	17.49	19.5	9.14	N/A	005-0922-00	271	11659.33
S1-ZRT250KCE-TFE-950	ZRT250KCE-TFE-950	237000	575-3-60	0		10.8	0.625	4.81	17.49	22.7	9.14	N/A	005-0922-00	289	12599.31
S1-ZR38K5E-TF5-800	ZR38K5E-TF5-800	38000	230/200-3-60	13.6	93	11.2	7/8	11.1	15.4	17.2	6.5	N/A	P	60	1970.44
S1-ZR38K5E-TFD-800	ZR38K5E-TFD-800	38000	460-3-60	6.4	48	11.2	7/8	11.1	15.4	17.2	6.5	N/A	P	60	1970.44
S1-ZR38K5E-TFE-800	ZR38K5E-TFE-800	38000	575-3-60	4.8	33	11.2	7/8	11.1	15.4	17.2	6.5	N/A	P	60	1962.71
S1-ZR42K5E-PFV-800	ZR42K5E-PFV-800	42200	208/230-1-60	22.1	104	11.3	7/8	11.1	15.4	17.2	6.5	55/370	P	68	1625.01
S1-ZR42K5E-TF5-800	ZR42K5E-TF5-800	42200	230/200-3-60	14.3	93	11.3	7/8	11.1	15.4	17.2	6.5	N/A	P	61	2010.36
S1-ZR42K5E-TFD-800	ZR42K5E-TFD-800	42200	460-3-60	6.4	48	11.3	7/8	11.1	15.4	17.2	6.5	N/A	P	61	2010.36
S1-ZR42K5E-TFE-800	ZR42K5E-TFE-800	42200	575-3-60	5.3	38	11.3	7/8	11.1	15.4	17.2	6.5	N/A	P	61	2001.80
S1-ZR48K5E-PFV-800	ZR48K5E-PFV-800	48200	208/230-1-60	21.4	135	11.3	7/8	11.1	15.4	17.2	6.5	60/440	P	72	1775.12
S1-ZR48K5E-TF5-800	ZR48K5E-TF5-800	48200	230/200-3-60			11.4	7/8	11.1	15.4	17.2	6.5	N/A	P	68	2104.48
S1-ZR48K5E-TFD-800	ZR48K5E-TFD-800	48200	460-3-60	7.9	58	11.4	7/8	11.1	15.4	17.2	6.5	N/A	P	68	2084.43
S1-ZR48K5E-TFE-800	ZR48K5E-TFE-800	48200	575-3-60			11.4	7/8	11.1	15.4	17.2	6.5	N/A	P	68	2209.57
S1-01504475005	ZR54K5E-PFV-800	53500	208/230-1-60	28.2	146	11.3	7/8	11.1	15.4	17.2	6.5	80/370	P	73	2343.50
S1-ZR54K5E-TF5-800	ZR54K5E-TF5-800	53500	230/200-3-60	17.1	114	11.3	7/8	11.1	15.4	17.2	6.5	N/A	P	69	2264.66
S1-ZR54K5E-TFD-800	ZR54K5E-TFD-800	53500	460-3-60	7.9	52	11.3	7/8	11.1	15.4	17.2	6.5	N/A	P	69	2264.66
S1-ZR54K5E-TFE-800	ZR54K5E-TFE-800	53500	575-3-60	5.9	39.5	11.3	7/8	11.1	15.4	17.2	6.5	N/A	P	69	2276.99
S1-ZR57KCE-TF5-830	ZR57KCE-TF5-830	57200	200/230-3-60	19.3	123.0	11.5	7/8	11.7	16.1	17.2	7.3	N/A	S	92	2313.72
S1-ZR61KCE-PFV-930	ZR61KCE-PFV-930	62000	208/230-1-60	32.1	148	11.4	7/8	11.68	16.13	17.75		80/370		90	2143.46
S1-ZR61KCE-TF5-930	ZR61KCE-TF5-930	62000	208/230-3-60	19.3	137	11.6	7/8	11.68	16.13	17.24				84	2337.47
S1-ZR61KCE-TF5-950	ZR61KCE-TF5-950	61000	230/200-3-60	19.3	123.0	11.5	7/8	13.3	17.8	18.9	7.3	N/A	S	94	2339.36
S1-ZR61KCE-TFD-930	ZR61KCE-TFD-930	62000	460-3-60	9.1	62	11.6	7/8	11.68	16.13	17.24				84	2337.47
S1-ZR61KCE-TFD-950	ZR61KCE-TFD-950	61000	460-3-60	10.0	62.0	11.5	7/8	13.3	17.8	18.9	7.3	N/A	S	94	2339.36
S1-ZR61KCE-TFE-930	ZR61KCE-TFE-930	58500	575-3-60	6.6	49	11.1	7/8	11.68	16.13	17.75	7.3			80	2358.76
S1-ZR68KCE-TF5-930	ZR68KCE-TF5-930	65500	200/230-3-60	18.6	156	10.9	7/8	11.68	16.13	17.75	7.3			86	2350.95
S1-ZR68KCE-TFD-930	ZR68KCE-TFD-930	65500	460-3-60	9	75	10.9	7/8	11.68	16.13	17.75	7.3			86	2358.62
S1-ZR68KCE-TFE-930	ZR68KCE-TFE-930	65500	575-3-60	7.4	54	10.9	7/8	11.68	16.13	17.75	7.3			85	2358.62
S1-ZR72KCE-TF5-950	ZR72KCE-TF5-950	72100	230/200-3-60	20.7	156.0	11.5	7/8	12.5	16.9	18.0	7.3	N/A	S	86	2417.71
S1-ZR72KCE-TFD-930	ZR72KCE-TFD-930	72100	460-3-60	10.0	70.0	11.5	7/8	12.5	16.9	18.0	7.3	N/A	S	86	2460.48
S1-ZR72KCE-TFD-950	ZR72KCE-TFD-950	73500	460-3-60	10	75	11.7	7/8	11.68	16.13	17.75				85	2417.71
S1-ZR72KCE-TFE-930	ZR72KCE-TFE-930	69500	575-3-60	7.4	54	11.2	7/8	11.68	16.13	17.75	7.3			86	2546.30
S1-ZR81KCE-TF5-950	ZR81KCE-TF5-950	77000	200/230-3-60	22.4	164	10.8	7/8	11.68	16.13	17.95	7.3			86	3058.63
S1-ZR84KCE-TF5-950	ZR84KCE-TF5-950	81500	200/230-3-60	25.6	196	11.2	1	1/8	3.69	17.49	18.75	9.14		126	4521.66
S1-ZR84KCE-TFD-950	ZR84KCE-TFD-950	81500	460-3-60	12.8	100	11.2	1	1/8	3.69	17.49	18.75	9.14		126	4521.66
S1-ZR94KCE-TFE-950	ZR94KCE-TFE-950	94000	575-3-60	10.8	80	11.4	1	1/8	3.69	17.49	18.75	9.14		126	4742.80

* NOTE: When substituting compressors always check the capacitor MFD and voltage (when required) and replace if necessary. The capacitor MUST be the proper MFD and voltage for the compressor.

COPELAND SCROLL ACCESSORIES

Capacity Control (Unloading) Valve With Gasket

SOURCE 1 PART NO.	DESCRIPTION	COMPRESSOR USED WITH	MLP \$
S1-02208704000	VALVE,CAPACITY CONTROL UNLOADING SPORLAN	2D,3D,4R,6R,4D,6D	500.15

Coil, Solenoid (Unloading)

SOURCE 1 PART NO.	DESCRIPTION	COMPRESSOR USED WITH	MLP \$
S1-02527939000	120 VOLT, EMERSON CLIMATE TECHNOLOGIES	2D,3D,4R,6R,4D,6D	561.33
S1-057341	24 VOLT, EMERSON CLIMATE TECHNOLOGIES	2D,3D,4R,6R,4D,6D	75.46

Control Module (Motor Protector) and Terminal Board

SOURCE 1 PART NO.	DESCRIPTION	COMPRESSOR USED WITH	MLP \$
S1-02533277000	MOTOR PROTECTOR CONTROL MODULE 24 V	2D,3D,4R,6R,4D,6D	820.07
S1-02535318000	MOTOR PROTECTOR CONTROL MODULE 120/240V	2D,3D,4R,6R,4D,6D	817.76

COPELAND SCROLL COMPRESSORS

Crankcase Heaters (CCH)

For Copeland Application



FIG. 1



FIG. 2



FIG. 3

SOURCE 1 PART NO.	COPELAND MODEL / B/M NO.	CAPACITY BTUH	LENGTH	VOLTAGE	WATTS	ARI EER	MLP
S1-02515525702	WRAP AROUND	2	27-33	240	54	ALL CR	30.58
S1-02517043700	WRAP AROUND	2	41-47	240	75	MEASURE CIRCUMFERENCE OF COMPRESSOR	28.96
S1-02519961701	WRAP AROUND	2	24-30	240	45	ALL CR	38.21
S1-02527413000	WRAP AROUND	2	22-26	240	42	ALL RE	41.11
S1-02528381700		1	N/A	240-600	40	ALL WITH "D" SHAPED WELL	60.64
S1-02531958000	WRAP AROUND	3	22-26	575	70	ZR UP TO 6-1/3 TONS	65.73
S1-02531959000	WRAP AROUND	2	22-26	240	70	ZR UP TO 6-1/3 TONS	109.62
S1-02531960000	WRAP AROUND	3	22-26	480	80	ZR UP TO 6-1/3 TONS	109.81
S1-02532895000		1	N/A	100-600	47	ALL WITH ROUND WELL	33.56
S1-02533474240	WRAP AROUND	2	29-36	240	90	ZR94	36.98
S1-02533474480	WRAP AROUND	2	29-36	480	90	ZR94	35.50
S1-02541000000	WRAP AROUND	2	19-22	240	40	ZR94	22.85

* **NOTE:** For proper application of insertion type CCH heat conductive compound S1-01301502000 (available from **SOURCE 1**) or equivalent **MUST** be used.

Premier Mfg. Compressor Blankets

For Noise Suppression

Features:

- Vinyl w/1/2 inch foam backing
- 1 inch wide velcro fasteners
- Die cut for proper fit
- UL recognized materials

SOURCE 1 PART NO.	FITS COMPRESSOR MODEL NO.	MLP
S1-01004621000	CR38K6 & SMALLER	75.35
S1-01005499000	ZR UP TO 3-1/2 TONS	98.94
S1-01005827000	BR, ZR94	108.45
S1-01004580000	CR42K6 & LARGER	179.70
S1-01004664000	ZR - 4 TO 6-1/3 TONS	72.23

Scott Mfg. "Acousticap" Compressor Blankets

For Noise Suppression

Features:

- Superior noise reduction (NRC = 85)
- Molded closed cell foam shell w/ acoustical liner
- Snap fasteners for ease of installation (some modification may be required)
- UL recognized materials

SOURCE 1 PART NO.	FITS COMPRESSOR MODEL NO.	MLP
S1-01005977000	CRN & LARGER	84.87
S1-01005979000	CRK THRU CRM, ZR40 & SMALLER	92.13
S1-01005980000	CRH & SMALLER, RE	79.26

Terminal Box, Parts and Accessories

SOURCE 1 PART NO.	DESCRIPTION	COMPRESSOR USED WITH	MLP
S1-02531493000	TERMINAL PARTS KIT	2D,3D,4R,6R,4D,6D	687.80

Compressors

COPELAND SCROLL COMPRESSORS

High Torque Start Components

Note:

Compressor Starting Characteristics Are Definite These High Torque Starting Components Are Listed For Copeland Compressors Only.

Start Capacitor



SOURCE 1 PART NO.	COMPRESSOR MODEL NO.	MFD/VAC	MLP \$
S1-02425191700	ZR28K3-PFV	88-108/330	12.58
S1-02425191700	ZR40K3-PFV	88-108/330	12.58
S1-02425191700	ZR34K3-PFV	88-108/330	12.58
S1-02425191700	ZR36K3-PFV	88-108/330	12.58
S1-02425191700	ZR22K3-PFV	88-108/330	12.58
S1-02425191700	ZR42K3-PFV	88-108/330	12.58
S1-02425191700	CR28K6-PFV	88-108/330	12.58
S1-02425191700	CR32K6-PFV	88-108/330	12.58
S1-02425191700	ZR26K3-PFV	88-108/330	12.58
S1-02425191700	ZR30K3-PFV	88-108/330	12.58
S1-02425075700	CRG3-0250-PFV	161-193/250	17.88
S1-02425215700	CRM3-0400-PFV	189-227/330	35.61
S1-02425215700	CR35K6-PFV	189-227/330	35.61
S1-02425215700	CR38K6-PFV	189-227/330	35.61
S1-02425215700	CR42K6-PFV	189-227/330	35.61
S1-02425215700	CRP5-0450-PFV	189-227/330	35.61
S1-02425215700	CRL3-0350-PFV	189-227/330	35.61
S1-02425215700	CRK3-0325-PFV	189-227/330	35.61
S1-02425215700	CRJ3-0300-PFV	189-227/330	35.61
S1-02425215700	CRH3-0275-PFV	189-227/330	35.61
S1-02425390700	ZR57K3-PFV	270-324/330	29.21
S1-02425390700	ZR61Z3-PFV	270-324/330	29.21
S1-02425390700	ZR46K3-PFV	270-324/330	29.21
S1-02425390700	ZR47KC-PFV	270-324/330	29.21
S1-02425390700	ZR49K3-PFV	270-324/330	29.21
S1-02425390700	ZR54K3-PFV	270-324/330	29.21

Roto-Lock Adapters

SOURCE 1 PART NO.	DESCRIPTION	MLP
S1-998-0034-02	ADAPTER, 7/8 STUB TO 1/25-12 ROTALOCK	65.42
S1-998-0034-04	ADAPTER, 1-3/8 STUB TO 1/75-12 ROTALOCK	304.21

LG SCROLL COMPRESSORS

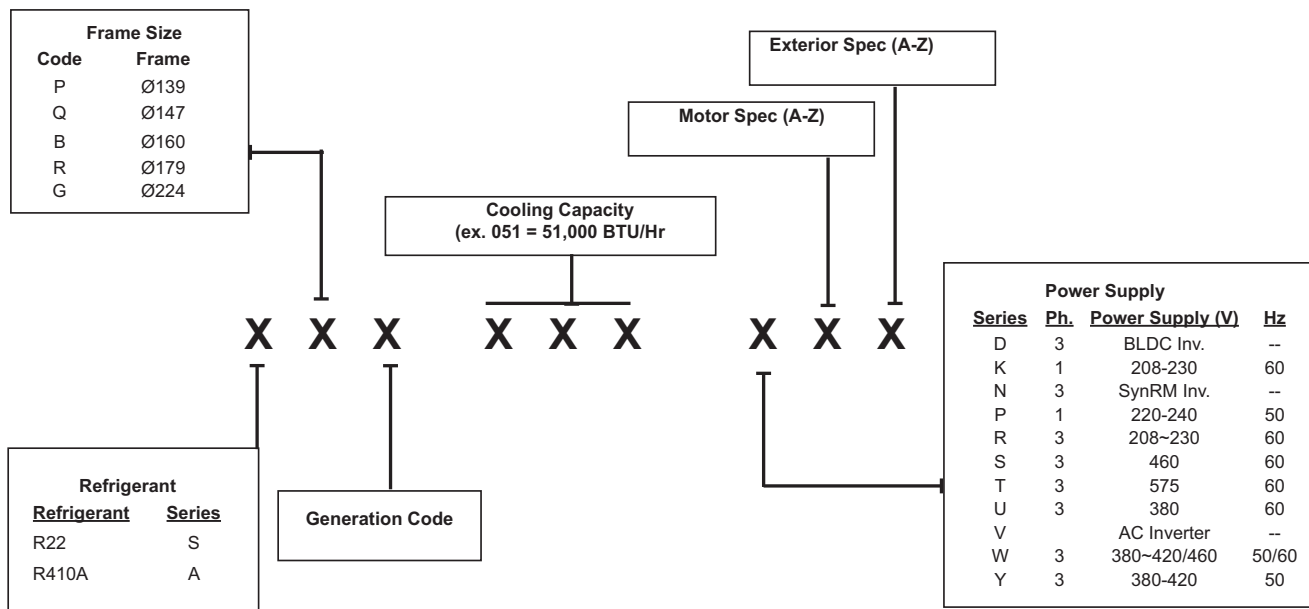

Compressors

LG SCROLL COMPRESSORS - R22



Features:

- Quiet Startup and Shutdown: Sound is minimized by a check valve in the discharge port.
- Discharge Temperature Protection (DTS): External thermal sensor protects against excessively high scroll temperatures
- Internal Pressure Relief (IPR): Relief valve opens at very high internal pressures protecting the unit.
- Internal Motor Overload Protection (OLP): thermal switch senses high temperature of compressor motor windings.
- Compressor Kit includes: Single wire harness (cover & gasket included), external thermal protector with cover, mounting hardware (grommets & sleeves), instruction sheet.
- Acceptable Refrigerant: R22 and R407C
- Voltage: 208/230
- Single Phase
- HZ: 60

SOURCE 1 PART NO.	REPLACES COPELAND MODEL	CAPACITY BTUH	APPL	PHASE	VOLTAGE	HZ	RUN CAP MFD/VOLTS	OIL TYPE	SUCTION		DISCH HT (D)	OVAL HT (H)	SHIP WT. (LBS.)	MLP
									ID	HT (S)				
S1-SQA022KAZ	ZR21K5-PFV	21,500	AC/HP	1	208-230	60	35/440	POE	3/4	11.12	15.41	16.90	60	1052.52
S1-SQA026KAZ	ZR25K5-PFV	26,100	AC/HP	1	208-230	60	35/440	POE	3/4	11.12	15.41	16.90	60	1096.96
S1-SQA032KAZ	ZR32K5-PFV	32,300	AC/HP	1	208-230	60	45/440	POE	3/4	11.12	15.41	16.90	60	1141.94
S1-SQA038KAZ	ZR38K5-PFV	37,000	AC/HP	1	208-230	60	50/440	POE	3/4	11.12	15.41	16.90	61	1206.09
S1-SQA042KAZ	ZR42K5-PFV	41,200	AC/HP	1	208-230	60	50/440	POE	3/4	11.12	15.41	16.90	61	1275.05
S1-SR047KBZ	ZR48K5-PFV	47,600	AC/HP	1	208-230	60	60/440	POE	7/8	12.79	17.24	18.94	96	1422.01
S1-SRA053KAZ	ZR54K5-PFV	53,500	AC/HP	1	208-230	60	70/440	POE	7/8	12.79	17.24	18.94	96	1504.90
S1-SR057KCZ	ZR57K3-PFV	58,000	AC/HP	1	208-230	60	70/440	POE	7/8	12.79	17.24	18.94	96	1545.11

LG SCROLL COMPRESSORS - R410A



Features:

- Axial Compliance by Gas Force Technology
- Higher Efficiency Design for 2015 Federal Regional Standards
- Robust Design with Various Safety Features: Protects against adverse operating conditions
- Compressor Kit includes: Single wire harness (cover & gasket included), mounting hardware (grommets & sleeves), instruction sheet
- Acceptable Refrigerant: R410A
- Voltage: 208/230
- Single Phase
- Hz: 60

SOURCE 1 PART NO.	REPLACES COPELAND MODEL	CAPACITY BTUH	APPL	PHASE	VOLTAGE	HZ	RUN CAP MFD/VOLTS	RLA	LRA	EER	SUCTION		DISCH ID	DISCH HT (D)	OVAL HT (H)	SHIP WT. (LBS.)	MLP
											ID	HT (S)					
S1-APG016KAC	ZP16K5E-PFV ZP16KAE-PFV ZP16K6E-PFV	15,500	AC/HP	1	208-230	60.0	35/370	7.7	48	9.8	3/4	10.37	1/2	14.30	15.21	51.4	1099.94
S1-APG020KAC	ZP20K5E-PFV ZP20KAE-PFV ZP20K6E-PFV	20,000	AC/HP	1	208-230	60.0	35/370	10.1	52	10.2	3/4	10.37	1/2	14.30	15.21	53.0	1106.60
S1-APG025KAC	ZP25K5E-PFV ZP25K6E-PFV	25,000	AC/HP	1	208-230	60.0	40/370	12.3	63	10.3	3/4	10.37	1/2	14.30	15.21	52.5	1152.68
S1-APG029KAC	ZP29K5E-PFV ZP29K6E-PFV	28,800	AC/HP	1	208-230	60.0	45/370	13.6	79	10.5	3/4	10.37	1/2	14.30	15.21	54.4	1189.78
S1-APG031KAC	ZP31K5E-PFV ZP31K6E-PFV	30,800	AC/HP	1	208-230	60.0	45/370	14.7	75	10.6	3/4	10.37	1/2	14.30	15.21	54.2	1189.78
S1-ABG034KAC	ZP34K5E-PFV ZP34K6E-PFV	34,350	AC/HP	1	208-230	60.0	45/440	15.9	112.3	10.4	7/8	11.62	1/2	15.50	16.51	70.9	1279.09
S1-ABG036KAC	ZP36K5E-PFV ZP36K6E-PFV	36,000	AC/HP	1	208-230	60.0	45/440	15.9	112	10.5	7/8	11.62	1/2	15.50	16.51	71.0	1215.52
S1-ABG039KAC	ZP39K5E-PFV ZP40K6E-PFV	39,500	AC/HP	1	208-230	60.0	70/370	16.9	94	10.6	7/8	11.62	1/2	15.50	16.51	71.3	1270.74
S1-ABG042KAC	ZP42K5E-PFV ZP42K6E-PFV	42,000	AC/HP	1	208-230	60.0	70/370	18.3	108	10.6	7/8	11.62	1/2	15.50	16.51	70.4	1285.30
S1-ABG049KAC	ZP49K5E-PFV ZP49K6E-PFV	49,400	AC/HP	1	208-230	60.0	70/440	20.8	127.1	10.8	7/8	11.62	1/2	15.50	16.51	72.5	1497.09
S1-ABG051KAC	ZP51K5E-PFV ZP51K6E-PFV	51,000	AC/HP	1	208-230	60.0	70/440	22.2	127.9	10.8	7/8	11.62	1/2	15.50	16.51	74.1	1497.09

Compressors

COMPRESSOR SOUND BLANKETS

SCOTT Acousticap® Compressor Blankets



Features:

- Superior noise reduction
- UL recognized
- Lightweight
- Easy installation
- Weatherability
- Cost-effective

ACOUSTICAL PERFORMANCE (SOUND ABSORPTION COEFFICIENTS)							
FREQUENCY (HZ) ABSORPTION AT 1/3 OCTAVE FREQUENCY							
ACOUSTICAP®	125	250	500	1000	2000	4000	NRC *
	.19	.49	.88	1.02	1.02	1.03	.85

* Noise Reduction Coefficient

Testing was in accordance with ASTM C-423 and performed by an outside laboratory accredited by the Department of Commerce.

ACOUSTICAL PERFORMANCE (SOUND TRANSMISSION LOSS)				
FREQUENCY HERTZ	SOURCE DB	RECEIVE DB	TL DB	STC CONTOUR
125	91.7	78.1	2.2	-5
250	91.4	79.6	2.7	4
500	93.3	79.6	5.8	11
1000	97.6	79.3	10.8	14
2000	97.3	69.8	17.6	15
4000	97.4	61.0	24.4	15

Sound Transmission Class (STC) = 11

Testing was in accordance with ASTM E-90 and performed by an outside laboratory accredited by the Department of Commerce.

SOURCE 1 PART NO.	SCOTT MFG. MODEL NO.	DIAMETER	HEIGHT	FOR USE WITH COMPRESSOR	MLP
S1-01005977000	SC9301A	9-1/2-11	15-17	H23A, H24A, H25A, H26A, H27A, H87A - ALL MODELS CRN AND LARGER	84.87
S1-01005979000	SC9520A	7-8-1/2	15-17	H20 AND H21C - ALL MODELS, H20 AND 21R - 483 AND SMALLER CRK - CRM, ZR40 AND SMALLER	92.13
S1-01005980000	SC9521A	7-8-1/2	12-15	H23B, H24B, H25B, H26B - ALL MODELS CRH AND SMALLER, RE ALL AW AND AV	79.26

Brinmar Sound Blankets



Brinmar Sound Blankets are a popular solution for reducing compressor noise, from air conditioners or heat pumps. The sound blanket fits inside the cabinet and wraps around the compressor -- the noisiest component of an air conditioner or heat pump. Brinmar's universal design accommodates hundreds of different styles and shapes of compressors. The two-piece design allows quick installation in tight cabinets where space is a consideration and where the compressor is close to the coil or the fan. The sound blanket is securely attached with hook and loop closures, which are durable and make installation quick and efficient.

Features:

- Minimum 5db (40%+) reduction of compressor noise
- Fits over 200 different compressor models, either recip or scroll
- Convenient, easy-to-install, universal-fit design

SOURCE 1 PART NO.	DESCRIPTION	LENGTH	WIDTH	HEIGHT	MLP
S1-SBLHD	BLANKET,COMPR,UNIV,12X12X19	12	12	19	101.62
S1-SBRHD	BLANKET,COMPR,UNIV,10X10X15	10	10	15	84.95
S1-SBSHD	BLANKET,COMPR,UNIV,8X8X15	8	8	15	87.13
S1-SBUHD	BLANKET,COMPR,UNIV,10X10X19	10	10	19	87.42

Thermostats

RESIDENTIAL & COMMERCIAL ACCESSORY THERMOSTATS

CTS Series Thermostat Accessories

Indoor/Outdoor Hardwired Temperature Sensor for CTS Series Thermostats



- Use for either indoor or outdoor temperature sensing
- Hardwired

SOURCE 1 PART NO.	DESCRIPTION	MLP \$
S1-CTSHTS	INDOOR/OUTDOOR HARDWIRED TEMPERATURE SENSOR FOR CTS SERIES THERMOSTATS	25.76

CTS Series Thermostat Accessories

Wall Plate for CTS Series Thermostats



Easily cover paint discrepancies or wall blemishes left after removal of old thermostats. Slim, attractive design.

SOURCE 1 PART NO.	DESCRIPTION	MLP \$
S1-CTSPLATE	WALL PLATE FOR CTS SERIES THERMOSTATS	14.72

Duct Temperature Sensor



Features:

- Sensor includes 20 feet of plenum-rated cable and can be installed in the supply/return duct
- Can be used as a supply air or return duct sensor with a CTS Series thermostat
- If used outdoor, this sensor can provide outside temperature for a CTS Series thermostat
- A small grommet is included to protect cable from sheet metal edges
- Two wire nuts are provided for wire connections
- For wire distances over 20 feet use 18 – 22 gauge 2 conductor unshielded thermostat wire
- Maximum distance between sensor and thermostat is 200ft • Measurement range is -40F ~ 131F

SOURCE 1 PART NO.	DESCRIPTION	MLP \$
S1-CTSDTS	SENSOR, TEMP, WIRED, DUCT, FOR CTS TSTATS	36.62

Thermostats

RESIDENTIAL & COMMERCIAL ACCESSORY THERMOSTATS

LX-Series Thermostat Accessories

Hardwired Outdoor Temperature Sensor

SOURCE 1 PART NO.	DESCRIPTION	MLP \$
S1-8052	HARDWIRED OUTDOOR TEMPERATURE SENSOR	14.66

Hardwired Indoor Temperature Sensor

SOURCE 1 PART NO.	DESCRIPTION	MLP \$
S1-8053	HARDWIRED INDOOR TEMPERATURE SENSOR	30.31

Locking Ring for LX-Series Thermostats



- Designed for easy tool-less slip-on installation and slip-off removal.
- Thermostat removal or wiring disconnection not required for installation.
- Can be combined with keypad lockout or setpoint limits.
- Locks both front and back thermostat housings to the wall.
- Elegant style and security at an affordable price.

SOURCE 1 PART NO.	DESCRIPTION	MLP \$
S1-LXLOCK	LOCKING RING FOR LX-SERIES THERMOSTATS	29.44

Wall Plate for LX-Series Thermostats



- Easily cover paint discrepancies or wall blemishes left after removal of old thermostats.
- Slim, attractive design.

SOURCE 1 PART NO.	DESCRIPTION	MLP \$
S1-LXPLATE	WALL PLATE FOR LX-SERIES THERMOSTATS	16.55

Add-A-Wire Accessory for All Conventional Thermostats



- One wire to run two wires worth of communication in applications where additional wire cannot be run.

SOURCE 1 PART NO.	DESCRIPTION	MLP \$
S1-ADDWIRE	ADD-A-WIRE ACCESSORY FOR ALL CONVENTIONAL THERMOSTATS	42.31

RESIDENTIAL ACCESSORY THERMOSTATS

Source 1 Value Series Thermostats



Features:

- Large digital display; programmable models are backlit
- Up to 2 stages heating and 2 stages cooling
- Battery or system powered
- Auxiliary heat indicator for heat pump models
- Fahrenheit or Celsius
- Separate mounting plate
- Manual changeover (except S1-THEM22P7S)
- Custom contractor logo available on battery covers for battery-powered models. Order S1-THEBATTCVR.
- Commercial model includes auto changeover, clock backup, up to 4-hour override, and keypad lockout

Accessories:

- Locking cover ring (S1-THELOCK)
- Decorative wall mounting back plate (S1-THEPLATE)
- Add-a-Wire Accessory (S1-ADDWIRE)

SOURCE 1 PART NO.	STAGES		PROGRAM	APPLICATIONS	BRANDS	POWER SOURCE	MLP \$
	HEAT	COOL					
S1-THEC11NS	1	1	N/A	SINGLE-STAGE HEAT PUMP, GAS/OIL/ELECTRIC, MILLIVOLT	SOURCE 1, FRASER-JOHNSTON	HARDWIRED OR BATTERY	67.39
S1-THEC11P5S	1	1	5-2 DAY	SINGLE-STAGE HEAT PUMP, GAS/OIL/ELECTRIC, MILLIVOLT	SOURCE 1, YORK, COLEMAN, LUXAIRE, FRASER-JOHNSTON	HARDWIRED OR BATTERY	80.95
S1-THEH21NS	2	1	N/A	HEAT PUMP	SOURCE 1, YORK, COLEMAN, LUXAIRE	HARDWIRED OR BATTERY	84.63
S1-THEH21P5S	2	1	5-2 DAY	HEAT PUMP	SOURCE 1, YORK, COLEMAN, LUXAIRE	HARDWIRED OR BATTERY	103.04

Thermostats

RESIDENTIAL ACCESSORY THERMOSTATS

Value Series Thermostat Accessories



S1-THELOCK



S1-THEPLATE



S1-ADDWIRE

SOURCE 1 PART NO.	DESCRIPTION	MLP \$
S1-ADDWIRE	ADD-A-WIRE ACCESSORY FOR ALL CONVENTIONAL THERMOSTATS	42.31
S1-THELOCK	LOCKING COVER FOR S1-THE SERIES THERMOSTATS	29.44
S1-THEPLATE	WALL MOUNTING PLATE FOR S1-THE SERIES THERMOSTATS	8.28

AIR CONDITIONING & HEATING CONTROLS

EMERSON DIGITAL THERMOSTATS

Emerson Blue™ Universal Touchscreen Thermostats



Features:

- Automatic heat/cool changeover option
- Installer-selectable system applications and programs
- 12-square-inch lighted display is the largest in the industry
- 4 time and 4 temperature settings per program (2 setbacks) heat and cool, or selectable— 2 time and 2 temperature settings (1 setback)
- Selectable Energy Management Recovery
- Permanent program retention during power outages
- Compressor lockout protection
- Maintains room temperature to within $\pm 1^\circ$
- Programmable Fan and Remote Sensing available for S1-1F95-1277 and S1-1F97- 1277

Specifications:

- **Dimensions:** 4.6"H x 5.9"W x 1.2"D
- **Setpoint Temperature Range:** 45°–99°F (7–32°C)
- **Rated Differential:** Heat 0.6°F; Cool 1.2°F
- **Operating Ambient Temperature:** 32°–105°F (0°–41°C)
- **Operating Humidity Range:** 90% non-condensing maximum
- **Battery:** mV to 30 VAC, NEC Class II, 50/60 Hz or DC
- **Input-Hardware:** 20–30 VAC 1.5A load per terminal; 2.5A maximum load (all terminals combined)

SOURCE 1 PART NO.	DISPLAY SIZE (SQ. IN.)	APPLICATIONS	SYSTEM/STAGES (HEAT/COOL)			PROGRAM	MLP \$
			SINGLE STAGE	MULTI STAGE	HEAT PUMP		
S1-1F95-1277	12.0	GAS/OIL/ELECTRIC, MILLIVOLT 3-WIRE ZONE VALVE	1/1	2/2	3/2	7, 5/1/1, 0	464.58
S1-1F95-1291	12.0	GAS/OIL/ELECTRIC, MILLIVOLT 3-WIRE ZONE VALVE, HUMIDIFY/DEHUMIDIFY	1/1	2/2	4/2	7, 5/1/1, 0	504.94
S1-1F97-1277	12.0	SINGLE-STAGE HEAT PUMP, GAS/OIL/ELECTRIC, MILLIVOLT	1/1	--	1/1	7, 5/1/1, 0	415.96

Emerson Temperature Sensors

Indoor Temperature Sensor

SOURCE 1 PART NO.	DESCRIPTION	MLP \$
S1-F145-1328	INDOOR TEMPERATURE SENSOR	78.06

Outdoor Temperature Sensor

SOURCE 1 PART NO.	DESCRIPTION	MLP \$
S1-F145-1378	OUTDOOR TEMPERATURE SENSOR	90.86

Thermostats

EMERSON DIGITAL THERMOSTATS

Emerson Blue™ 2-Inch Thermostats

For Single-Stage & Heat Pump Applications



Features:

- Easy-to-read lighted LCD display
- Dual-powered—choice of battery-powered or hardwired for all applications
- Fast (FA) or slow (SL) heating cycle anticipation
- Easy-to-wire push-connect color-coded terminals
- Compressor lockout protection
- Millivolt compatible
- Electric heat option

Programmable Model Features:

- 4 time and 4 temperature settings per program (heat and cool)
- Energy savings up to 33%
- Permanent program retention during power loss
- Setpoint Hold
- Temporary temperature override two-hour minimum or until next program period
- Selectable Energy Management Recovery
- Meet Energy Star specifications (S1-1F82- 0261 & S1-1F80-0261)
- Meets California Building Code, Title 24

Specifications:

- **Dimensions:** 4.8"W x 3.8"H x 1.5"D
- **Electrical Rating:** 0–30 VAC, 50/60 Hz or DC, 0.05–1.5 Amps (load per terminal), 1.5 Amps maximum load (all terminals combined)
- **Standard Systems:** gas, oil, electric, single stage/heat pump, millivolt
- **Setpoint Temperature Range:** 45°F–90°F (7°–32°C)
- **Rated Differential:** 0.6°–1.7°F with adjustable anticipation
- **Operating Ambient Temperature:** 32°–105°F (0°–40°C)
- **Operating Humidity Range:** 90% non-condensing maximum
- **Shipping Temperature Range:** –40°–150°F (–40°–65°C)

SOURCE 1 PART NO.	DISPLAY SIZE (SQ. IN.)	APPLICATIONS	STAGES		PROGRAM	POWER	ENERGY MANAGEMENT RECOVERY	TERMINATIONS	MLP \$
			HEAT	COOL					
S1-1F80-0224	2.0	GAS/OIL/ ELECTRIC, MILLIVOLT	1	1	24-HOUR	BATTERY, HARDWIRED	YES	R, C, Y, W, G, O/B	124.02
S1-1F80-0261	2.0	GAS/OIL/ ELECTRIC, MILLIVOLT	1	1	5/1/1	BATTERY, HARDWIRED	YES	R, C, Y, W, G, O/B	152.29
S1-1F86-0244	2.0	GAS/OIL/ELECTRIC, MILLIVOLT	1	1	--	BATTERY, HARDWIRED	NO	R, C, Y, W, G, O/B	100.82

Thermostats

EMERSON DIGITAL THERMOSTATS

Emerson Blue Easy Reader™ 6-Inch Thermostat



THERMOSTAT CONFIGURATION OPTIONS	THERMOSTAT APPLICATIONS	MAXIMUM STAGES HEAT/COOL
SINGLE STAGE 1 NO HEAT PUMP (SS1)	GAS, OIL, ELECTRIC, HEAT ONLY, COOL ONLY OR HEAT/COOL SYSTEMS, 2 OR 3 WIRE HYDRONIC ZONE (HOT WATER OR STEAM) SYSTEMS, 24 VOLT OR MILLIVOLT	1/1
MULTI STAGE 2 NO HEAT PUMP (MS2)		2/2
HEAT PUMP 1 SINGLE STAGE COMPRESSOR HEAT PUMP (HP1)	SINGLE STAGE COMPRESSOR HEAT PUMP SYSTEMS - UP TO 2 STAGES AUX./ EMERGENCY HEAT	3/1
HEAT PUMP 2 TWO STAGE OR TWO COMPRESSOR HEAT PUMP (HP2)	TWO STAGE OR TWO COMPRESSOR HEAT PUMP SYSTEMS - UP TO 2 STAGES AUX/ EMERGENCY HEAT	4/2

Features:

- Backlit 6in. display with large characters
- 7 day programmable
- Millivolt compatible
- "Call for service" diagnostic indicator, filter change reminder
- Compatible with most heating, cooling, and heat-pump systems.

Specifications:

- **Dimensions:** 4 3/16"H x 6-1/2"W x 1-5/8"D
- **Electrical:** Battery Power - mV to 30 VAC, NEC Class II, 50/60 Hz or DC. Input- Hardware - 20 to 30 VAC
- **Load (per terminal):** 1.5A

- **Load (all terminals combined):** 2.5 A maximum
- **Setpoint Temperature Range:** 45°–99°F (7°– 32°C)
- **Differential:**

	Fast	Med.	Slow
Heat (Single/Multi Stage)	0.4°F	0.6°F	1.7°F
Cool (Single/Multi Stage)	0.9°F	1.2°F	1.7°F
Heat Pump	0.9°F	1.2°F	1.7°F
Aux. Heat	0.6°F	--	1.7°F
- **Operating Ambient Temperature:** 32°–105°F (0° to +40°C)
- **Operating Humidity Range:** 90% non-condensing maximum
- **Accessories:** Wall plate, 6.5"W x 5"H (vendor part number F61-2634) included with S1-1F80- 0471

SOURCE 1 PART NO.	POWER	MLP \$
S1-1F95EZ-0671	T*STAT,PRGRM,7-DAY,3(4)H/2C,EMERSON	298.20

Emerson 80 Series™ Thermostats



Features:

- Built-in level and universal back plate for easy installation.
- Large back-lit display.
- Temperature limits and keypad lockout standard on every model.
- Select models feature auto changeover, filter change reminders, dual fuel control and selectable programming.

Specifications:

- **Dimensions:** 3-3/4"Hx6"Wx1-1/8"D
- **Electrical:** Rating 0–30 VAC, 50/60 Hz or DC
- **Load (per terminal):** 1.0 A -1.5 A
- **Load (all terminals combined):** 1.5 A - 2.5 A maximum
- **Setpoint Temperature Range:** 45°–99°F (7°– 32°C)
- **Differential:** 0.5°–1.9°F with adjustable anticipation
- **Operating Ambient Temperature:** 32°–105°F (0°–41°C)
- **Operating Humidity Range:** 90% non-condensing maximum
- **Accessories:** Wall plate, 6-3/4"W x 4-1/2"H (vendor part number F61-2663) & Thermostat Guard (F29-0198)

SOURCE 1 PART NO.	MAXIMUM STAGES (HEAT/COOL)		PROGRAM	APPLICATIONS	POWER	MLP \$
	CONV	HEAT PUMP				
S1-1F85U-22PR	2/2	2/1	7, 5/1/1, 0	GAS/OIL/ELECTRIC, MILLIVOLT 3-WIREZONE VALVE	BATTERY,HARDWIRED	219.39
S1-1F83H-21NP	--	2/1	0	GAS/OIL/ELECTRIC	BATTERY,HARDWIRED POWER ASSIST	130.88
S1-1F83C-11PR	1/1	1/1	7, 5/1/1, 0	GAS/OIL/ELECTRIC, MILLIVOLT 3-WIREZONE VALVE	BATTERY,HARDWIRED POWER ASSIST	159.98

Thermostats

RESIDENTIAL ACCESSORY THERMOSTATS

ICM Temporary Construction Thermostats



The SC045 to SC075 series thermostats are low-cost, single setpoint thermostats intended for use as temporary devices to provide heating or cooling to allow drywall to dry during construction. They also can be used as a low ambient cutoff switch.

Features:

- Two-wire installation
- Six fixed setpoint models to choose from: 45oF to 75oF
- Temporary use for dryout applications
- Can be used as a low ambient cutoff switch

Specifications:

Input: 18-30 VAC

Output: 2 amp maximum

Temperature Control Range: 45°F to 75°F (±5°F)

Mode Of Operation

Heat/Cool Thermostat- The heating models will close when the ambient temperature drops below the respective setpoint and open when the ambient temperature is above the respective setpoint. The cooling models will close when the ambient temperature is above the respective setpoint and open when the ambient temperature drops below the respective setpoint.

Low Ambient Cutoff: Condenser Fan Motor- The SC045 and SC055 models can be used as a low ambient cutoff switch for a condenser fan motor. When the ambient temperature drops below the setpoint, the unit will open the fan signal and turn the fan motor off. It will not allow the fan to turn back on until the temperature rises above the setpoint.

Low Ambient Cutoff: Compressor- The SC045 and SC055 models can also be used as a low ambient cutoff switch for the compressor when wired in series with the Y circuit from the thermostat. When using with the compressor circuit, an anti-short cycle timer is recommended to prevent possible damage to the compressor from short cycling.

SOURCE 1 PART NO.	TEMPERATURE RANGE*	2-WIRE	HEAT	COOL	MLP \$
S1-SC055	55°F ±5°	YES	NO	YES	21.82
S1-SC060	60°F ±5°	YES	YES	NO	17.09
S1-SC065	65°F ±5°	YES	YES	NO	17.09
S1-SC070	70°F ±5°	YES	YES	NO	17.09
S1-SC075	75°F ±5°	YES	NO	YES	21.82

AIR CONDITIONING & HEATING CONTROLS

Air Conditioning & Refrigeration Controls

SIGHT GLASSES & MOISTURE INDICATORS

SOURCE 1® Sight Glasses



Sight glass and moisture indicator provides a quick visual indication of refrigerant and moisture levels within a system. The sight glass indicates if the system has the proper refrigerant level, a restricted dryer, or excessive pressure-drop. The moisture indicator recognizes moisture within the system, which may indicate a problem that could result in corrosion, chemical damage, restricted flow, or even compressor failure. Etch-resistant glass with a simple color comparison provides easy viewing and quick diagnostics. Sweat models feature copper fittings to permit solder installation without disassembly. Leak-proof design is compact and short in length to easily fit within a unit.

SOURCE 1 PART NO.	CONNECTIONS (INCHES)	MLP \$
S1-SG-3S	SWEAT 3/8	24.79
S1-SG-4S	SWEAT 1/2	30.51

Sporlan See-All Moisture and Liquid Indicator



Features:

- Extremely accurate
- Full view sight glass
- Indicator protected by filter pad and screen
- Replaceable indicator element

SOURCE 1 PART NO.	SPORLAN PART NO.	DWG NO.	CONNECTION SIZE AND TYPE	OVERALL LENGTH	SHIPPING WT. (LBS.)	MLP \$
S1-700026	SA-12FM	SA-1	1/4 SAE M X 1/4 SAE F	2.56	.50	44.04
S1-700052	SA-12S	SA-2	1/4 ODF	4.62	.50	42.77
S1-700078	SA-13		3/8 SAE	3.37		43.97
S1-700091	SA-13FM	SA-1	3/8 SAE M X 3/8 SAE F	2.97	.50	44.63
S1-700130	SA-13S	SA-2	3/8 ODF	4.62	.50	43.49
S1-700260	SA-14FM	SA-1	1/2 SAE M X 1/2 SAE F	3.44	.63	53.69
S1-700299	SA-14S	SA-2	1/2 ODF	4.87	1.00	54.04
S1-700416	SA-15S	SA-2	5/8 ODF	4.87	1.00	54.97
S1-SV-700468	SA-15U	SA-2	5/8" M FLARE X F SWIVEL	4.87	1.00	73.26
S1-700507	SA-17S	SA-2	7/8 ODF	6.31	1.50	81.16
S1-700546	SA-19S	SA-2	1-1/8 ODF	6.31	1.50	82.78

SEE-ALL SHOWS	MOISTURE CONTENT PPM							
	R-22		R-134A		R-404A & R507		R-407C	R-410A
	LIQUID LINE TEMP							
	25°C	40°C	25°C	40°C	25°C	40°C	25°C	25°C
GREEN DRY	BELOW 30	BELOW 45	BELOW 50	BELOW 80	BELOW 15	BELOW 30	BELOW 120	BELOW 75
CHARTREUSE CAUTION	30-90	45-130	50-200	80-225	15-90	30-140	120-280	75-150
YELLOW WET	ABOVE 90	ABOVE 130	ABOVE 200	ABOVE 225	ABOVE 90	ABOVE 140	ABOVE 280	ABOVE 150

NOTE: Change or add Catch-All Filter-Drier when paper turns from green to chartreuse.

BOLD figures are for the average design conditions of refrigerant liquid lines operating at 100°F. Since the actual temperature is not critical, a satisfactory estimate can be made by comparing it to body temperature. If it feels cool to the touch, use 75°F; if it feels warm, use 125°F column figures.

DRIERS

SOURCE 1® Liquid Line Filter Driers (Solid Core)



Features:

- Solid Core Design for increased service life
- XH-11 molecular sieve with activated Alumina
- Compatible with all refrigerants, including 134a, 401 A/B, 402 A/B, 404A, 407 A/B/C, 410A, 502, 507A
- Solid copper sweat connection fittings, Steel tube body
- Drier meets ANSI 63.1-1995
- Desiccant meets ANSI 35-1992
- Max Working Pressure = 680 psi, Min Burst Pressure = 3400 psi
- Powder Coat meets 500hr salt spray
- UL Listed

SOURCE 1 PART NO.	TYPE	ODF	CU IN	MLP \$
S1-SLFD053S	LIQUID	3/8	5	25.80
S1-SLFD083S	LIQUID	3/8	8	27.42
S1-SLFD163S	LIQUID	3/8	16	28.80
S1-SLFD164S	LIQUID	1/2	16	26.67
S1-SLFD305S	LIQUID	5/8	30	47.13

Air Conditioning & Refrigeration Controls

DRIERS

Sporlan Catch-All Liquid Line Filter-Driers



Features:

- Leakproof shell
- Solid copper sweat fittings
- Outlet safety filter
- A blend of desiccants for maximum moisture removal
- Lower end point dryness levels, Maximum working pressure: 650 psi
- Compatible with refrigerants 12, 22, 134a, 404A, 407C, 410A, 502, 507



AIR CONDITIONING & HEATING CONTROLS

SOURCE 1 PART NO.	SPORLAN MODEL NO.	CONNECTION SIZE & TYPE	DIMENSIONS		SURFACE FILTERING AREA SQ. CM	HCFC-22			R410A			SHIP WT (LBS).	MLP \$
			BODY DIAMETER (IN.) B	LENGTH (IN.) A		WATER CAP. DROPS AT 60 PPM 25°C	WATER CAP. DROPS AT 60 PPM 50°C	REFRIG. FLOW CAP KW AT 0.07 BAR DP	WATER CAP. DROPS AT 50 PPM 25°C	WATER CAP. DROPS AT 50 PPM 50°C	REFRIG. FLOW CAP KW AT 0.07 BAR DP		
S1-400000	C-032	1/4 SAE	1.75	4.19	58	61	50	5.3	27	20	4.9	1.75	28.96
S1-400001	C-033S	3/8 ODF	1.75	3.88	58	3.1	2.5	13.4	1.4	1.0	13.0	.50	29.95
S1-400016	C-032-F	1/4 SAE	1.75	4.19	58	61	50	5.3	27	20	4.9	1.75	30.93
S1-400032	C-032-FM	1/4 SAE	1.75	4.19	58	61	50	5.3	27	20	4.9	1.75	30.93
S1-400052	C-032S	1/4 ODF	1.75	3.81	58	3.1	2.5	5.28	1.4	1.0	4.92	.50	28.96
S1-400072	C-032-CAPT	1/4 SAE	1.75	4.19	58	61	50	5.3	27	20	4.9	1.75	46.04
S1-400200	C-052	1/4 SAE	2.44	4.75	97	149	119	7.4	63	48	7.0	2.44	34.17
S1-400210	C-0525S	5/16 ODF	2.44	4.38	97	7.3	6.0	12.0	3.2	2.4	11.6	.75	41.20
S1-400249	C-052S	1/4 ODF	2.44	4.75	97	7.3	6.0	7.39	3.2	2.4	7.03	.75	33.80
S1-400288	C-053	3/8 SAE	2.44	4.19	97	149	119	14.4	63	48	14.0	2.44	34.68
S1-400329	C-053S	3/8 ODF	2.44	4.31	97	7.3	6.0	16.5	3.2	2.4	15.8	.75	33.80
S1-400416	C-082	1/4 SAE	2.62	5.62	188	240	196	7.4	104	78	7.0	2.62	42.59
S1-400429	C-082S	1/4 ODF	2.62	5.12	135	12.0	9.8	7.39	5.2	3.9	7.03	1.25	43.97
S1-400435	C-083-S-HH	3/8 ODF	2.62	5.25	188	240	196	18.3	104	78	17.6	2.62	50.19
S1-400437	C-084S	1/2 ODF	2.62	5.44	135	12.0	9.8	33.8	5.2	3.9	33.1	1.25	44.44
S1-400472	C-083	3/8 SAE	2.62	6.06	188	240	196	15.8	104	78	15.4	2.62	41.52
S1-400503	C-083-S	3/8 ODF	2.62	5.25	135	12	9.8	18.3	5.2	3.9	17.6	1.25	41.52
S1-400536	C-084	1/2 SAE	2.62	6.31	188	240	196	28.4	104	78	27.7	2.62	47.54
S1-401000	C-162	1/4 SAE	3.00	6.25	213	364	297	7.4	158	119	7.0	3.00	55.45
S1-401018	C-162S	1/4 ODF	3.00	5.75	213	17.3	14.9	7.39	7.9	6.0	7.03	1.75	59.05
S1-401021	C-163-S	3/8 ODF	3.00	5.88	213	17.3	14.9	18.3	7.9	6	17.6	1.75	53.34
S1-401022	C-163-S-HH	3/8 ODF	3.00	5.88	213	364	297	18.3	158	119	17.6	3.00	60.69
S1-401023	C-164-S	1/2 ODF	3.00	6.00	213	17.3	14.9	38.7	7.9	6	37.6	1.75	58.25
S1-401025	C-164-S-HH	1/2 ODF	3.00	6.00	213	364	297	38.6	158	119	37.6	3.00	68.96
S1-401031	C-167-S	7/8 ODF	3.00	6.93	213	364	297		158	119		3.00	71.70
S1-401035	C-165-S	5/8 ODF	3.00	6.31	213	17.3	14.9	55.9	7.9	6	54.5	1.75	61.75
S1-401048	C-163	3/8 SAE	3.00	6.75	213	364	297	15.8	158	119	15.4	3.00	53.34
S1-401080	C-163-HH	3/8 SAE	3.00	6.75	213	364	297	15.8	158	119	15.4	3.00	62.18
S1-401128	C-164	1/2 SAE	3.00	6.94	213	364	297	35.5	158	119	34.4	3.00	58.25
S1-401216	C-165	5/8 SAE	3.00	7.25	213	364	297	42.5	158	119	41.1	3.00	62.36
S1-401305	C-303S	3/8 ODF	3.00	8.88	342	34.8	28.4	38.7	15.1	11.4	37.6	3.50	98.94
S1-401307	C-304-S	1/2 ODF	3.00	9.00	342	696	567	38.6	302	227	37.6	3.00	95.30
S1-401313	C-306S	3/4 ODF	3.00	9.65	342	34.8	28.4		15.1	11.4		3.50	117.51
S1-401317	C-309S	1-1/8 ODF	3.00	9.75	342	34.8	28.4		15.1	11.4		3.50	125.64
S1-401360	C-304	1/2 SAE	3.00	9.88	342	696	567	35.5	302	227	34.4	3.00	95.30
S1-401408	C-305	5/8 SAE	3.00	10.19	342	696	567	52.3	302	227	50.9	3.00	95.30
S1-401449	C-305S	5/8 ODF	3.00	9.25	342	34.8	28.4	59.4	15.1	11.4	57.7	3.50	95.30
S1-401505	C-307S	7/8 ODF	3.00	9.80	342	34.8	28.4	76.0	15.1	11.4	73.9	3.50	106.77
S1-401609	C-414S	1/2 ODF	3.50	9.05	432	46.8	35.7	43.6	20.4	15.3	42.6	4.50	141.85
S1-SV-401672	C-415-HH	5/8 ODF	3.50	10.25	432	936	763	61.4	407	305	60.0	4.50	172.24
S1-401610	C-415-S	5/8 ODF	3.50	9.35	432	936	763	61.4	407	305	60.0	3.50	140.67
S1-401618	C-419S	1-1/8 ODF	3.50	9.75	432	46.8	35.7	85.5	20.4	15.3	83.4	4.50	162.22
S1-401656	C-415	5/8 SAE	3.50	10.25	432	936	763	55.5	407	305	54.1	3.50	151.20
S1-401865	C-609-S	1-1/8 ODF	3.00	16.00	684	69.6	56.7	102.0	30.2	22.7	114.0	6.00	218.79
S1-SV-402251	C-967-G T/C	7/8 ODF	4.75	14.84	128								676.98
S1-52636217000	C-417S	7/8 ODF	3.50	9.81	432	46.8	35.7	77.7	20.4	15.3	25.6	4.50	171.27

Air Conditioning & Refrigeration Controls

DRIERS

Sporlan Replaceable Core Filter-Driers

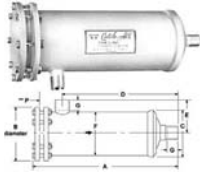

Features:

- Molded porous core maximum water capacity
- Nut and bolt attachment at end plate allows for simple installation
- Tie-rod construction for easy core replacement
- All internal parts are plated steel
- Exterior shell painted to prevent corrosion



AIR CONDITIONING & HEATING CONTROLS

SOURCE 1 PART NO.	SPORLAN MODEL NO.	CONNECTION SIZE & TYPE	NO. OF CORES	CORE PART NO	VOLUME OF DESICCANT CU. IN.	A	B	C	D	E	F	G	P*	SHIP WT.	MLP \$
S1-402082	C-485-G	5/8 ODF	1	RCW-48, RCW-4864, OR RCW-4864-HH	48	9.15	6.00	5.00	5.92	3.50	4.75	0.50	7.50	12.00	526.50
S1-402109	C-487-G	7/8 ODF	1	RCW-48, RCW-4864, OR RCW-4864-HH	48	9.30	6.00	5.00	6.07	3.72	4.75	.75	7.50	12.00	537.10
S1-402152	C-489-G	1-1/8 ODF	1	RC-4864, RC-4864-HH OR RCW-48	48	9.50	6.00	5.00	6.37	3.78	4.75	.91	7.50	12.00	563.62
S1-402159	C-4811-G	1-3/8 ODF	1	RC-4864, RC-4864-HH OR RCW-48	48	9.60	6.00	5.00	6.37	3.94	4.75	.97	7.50	12.00	582.12

*P Indicates pull space required to change core.

Sporlan Filter Cores

Replaceable Cores



Features:

- Individually packaged in metal cans
- Fully activated
- Hermetically sealed
- Instructions on each can for easy installation
- Includes a triple gasket

RC-4864 – Activated Core - order as separate item - fits types C-480 thru C-19200 series shells. This is the standard core suitable for most installations in the liquid line or suction line.

RC-4864-HH – Activated Charcoal Core – order as separate item - fits types C-480 thru C-19200 series shells. This core should be used for wax removal on low temperature R-22 and R-502 systems, and for clean-up after hermetic motor burnout on all types of systems.

RCW-42 — High Water Capacity Core — Order as separate item — Fits ONLY shell types C-R424, C-R425, and CR427. Designed specially for use with POE oils. This core should be used on systems that have a ruptured water cooled condenser, or that have been exposed to the atmosphere, or for some reason have a high amount of moisture in the system.

SOURCE 1 PART NO.	SPORLAN PART NO.	CORE DIMENSIONS O.D. X LENGTH	SHIPPING WEIGHT (LBS.)	FOR USE WITH REPLACEABLE FILTER DRIER	MLP \$
S1-404360	RC-4864	3.74" X 5.50"	2.33	C-480 THRU C-19200	61.67
S1-404380	RC-4864-HH	3.74" X 5.50"	2.33	C-480 THRU C-1200	96.69
S1-404400	RC-10098	4.80 X 6.47	4.67	C-30000 AND C-40000	172.24
S1-404401	RCW-48	3.74 X 5.5	28	C-480 THRU C-19200	103.39
S1-404403	RCW-100	4.80 X 6.47	4.67	C-30000 AND C-40000	236.78
S1-404404	RCW-42	3.18 X 6.00	2.20	C-R424, C-R425 AND C-R427	71.87
S1-404420	RC-10098-HH	4.80 X 6.47	4.67	C-30000 AND C-40000	215.48

SOURCE 1® Bi-Flow Filter-Driers



Features:

- Specifically designed for heat pump or reverse cycle application
- External check valves are not required since they are incorporated within the filter drier shell
- The core design filters out contaminant particles down to 25 microns, 100% copper sweat fittings
- Desiccant core provides three times the filtration as the standard bi-flow
- Core is cushioned in fiber gaskets to protect core and to ensure trouble-free performance
- Corrosion-resistant powder coated exterior surpasses 500-hr ASTM salt spray test

Specifications:

Maximum working pressure: 680 psi*

*Note: Above pressure rating is valid for Source 1 driers manufactured after June, 2009. These driers can be identified by the UL mark on the box and drier label.

SOURCE 1 PART NO.	TYPE	ODF	CU IN.	MLP \$
S1-BFD083S	BI-FLOW	3/8	8	30.40
S1-BFD163S	BI-FLOW	3/8	16	40.55

Air Conditioning & Refrigeration Controls

DRIERS

Sporlan Catch-All Suction Line Filter-Driers

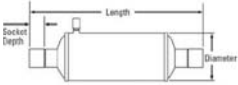

Sporlan Suction Line Filter-Driers are designed specifically for CLEAN-UP after BURNOUT using the HH TYPE CHARCOAL CORE.

Features:

- Positive protection for the compressor, Most economical method of clean-up
- Minimum down time — system operates during clean-up.
- Method is applicable to almost any size system
- Removes all contaminants — moisture, acid, sludges, dirt...
- Recommended by the leading equipment manufacturers

SOURCE 1 PART NO.	SPORLAN PART NO.	CONNECTION SIZE & TYPE	BODY DIAMETER (INCHES)	LENGTH A (INCHES)	SURFACE FILTERING AREA (SqCm)	SHIP WT.	MLP \$
S1-401026	C-164-S-T-HH	1/2 ODF	3.00	6.00	213	1.75	86.88
S1-401029	C-165-S-T-HH	5/8 ODF	3.00	6.31	213	1.75	88.70
S1-401030	C-166-S-T-HH	3/4 ODF	3.00	6.75	213	1.75	93.77
S1-401033	C-167-S-T-HH	7/8 ODF	3.00	6.93	213	1.75	92.86
S1-401316	C-307-S-T-HH	7/8 ODF	3.00	9.80	342	3.5	143.57
S1-401318	C-309-S-T-HH	1-1/8 ODF	3.00	9.75	342	3.5	157.34

Sporlan Reversible Heat Pump Filter-Driers

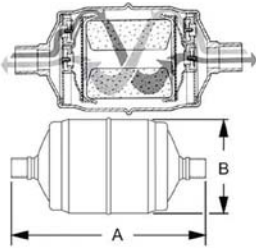

Features:

- A short overall length for easy installation.
- Proven metal check valves used in construction – no synthetic materials.
- The Sporlan dependable molded core used for maximum filtration ability. When the flow direction reverses, dirt already collected remains in the filter-drier, Drier operates in either flow direction with low pressure drop.
- A carefully engineered blend of desiccants for maximum water capacity and acid removal ability.
- The HPC-160-HH Series also has the HH style core with activated charcoal which offers maximum ability to remove oleoresin and other reactive chemical constituents in the oil.
- Same rugged construction as used in the Catch-All, Maximum working pressure: 650 psi
- Compatible with refrigerants 12, 22, 134a, 404A, 407C, 410A, 502, 507



SOURCE 1 PART NO.	SPORLAN PART NO.	CONN	DIMENSIONS		SURFACE FILTERING AREA (SqCm)	FLOW CAP TONS @ 1PSI	WATER CAP R-22 DROPS @ 60PPM	REFRIG FLOW CAP @ 2 PSI PRESS. DROP (TONS)	FLOW CAP TONS @ 1PSI	SHIP WT (LBS)	WATER CAP R-22 DROPS @ 60PPM	WATER CAP R-410A DROPS @ 50PPM			LIQUID CAP OUNCES @ 100F		MLP \$
			BODY DIAM B	LENGTH A		WATER CAP DROPS (125°) AT 60 PPM 75°F	WATER CAP DROPS (125°) AT 60 PPM 125°F		R-22		125F	75F	125F	R-22	R-410A		
S1-401372	HPC-305-S-HH	5/8 ODF	3.00	10.42		9.8	167	10.8		10.8	119	123	109	19.7	17.2	167.32	
S1-401373	HPC-307-S-HH	7/8 ODF	3.00	11.02		10.6	167	10.8		10.8	119	123	109	19.7	17.2	170.71	
S1-404101	HPC-103-S	3/8 ODF	3.00	5.88	18	215	176	4.7	1.75							72.72	
S1-404161	HPC-104-S	1/2 ODF	3.00	6.00	18	215	176	6.3	1.75							76.25	
S1-404180	HPC-163-HH	3/8 SAE	3.00	7.78		4.7	93	4.8		4.8	81	69	100	14.5	12.6	108.33	
S1-404201	HPC-163-S-HH	3/8 ODF	3.00	6.92	26	93	81	3.7								106.77	
S1-404241	HPC-164-S-HH	1/2 ODF	3.00	7.07	26	93	81	4								108.52	
S1-404281	HPC-165-S-HH	5/8 ODF	3.00	7.35	26	93	81	6.8	1.75							112.33	

Sporlan Compact Style Suction Line Filter-Driers

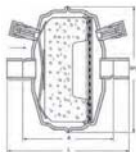

Features:

- Short overall length
- Suitable for cramped piping situations

SOURCE 1 PART NO.	SPORLAN MODEL NO.	CONNECTION SIZE & TYPE	BODY DIAMETER	LENGTH	SHIP WT	MLP \$
S1-400806	C-146-S-TT-HH	3/4 ODF	4.44	4.83	2	109.14
S1-400811	C-147-S-TT-HH	7/8 ODF	4.44	4.97	2	113.00

Air Conditioning & Refrigeration Controls

FILTERS

Sporlan SF - Suction Filter

Types with Bypass Relief Valve (Bi-Directional Flow)

SOURCE 1 PART NO.	SPORLAN PART NO.		CONN	FILTER AREA SQ. IN.	OVERALL LENGTH	SHELL DIA	SHIP WT (LBS.)	RATINGS AT ARI STANDARD 730 CONDITIONS			MLP \$
	W/O ACCESS VALVE	W/ ACCESS VALVE						WATER CAP DROPS @ 60 PPM 75°F	WATER CAP DROPS @ 60 PPM 125°F	REFRIG FLOW CAP TONS @ 3 PSI	
S1-800001	—	SF-286-T	3/4 ODF	28	8.79	3	2.25	N/A	N/A	8.6	120.25
S1-800002	—	SF-287-T	7/8 ODF	28	8.93	3	2.25	N/A	N/A	11.1	117.88
S1-800006	—	SF-289-T	1-1/8 ODF	28	9.51	3	2.25	N/A	N/A	14.8	127.25
S1-800008	—	SF-4811-T	1-3/8 ODF	48	13.1	3	3	N/A	N/A	18.4	184.80
S1-800037	—	SF-285-T	5/8 ODF	28	8.34	3	2.25	N/A	N/A	6.4	112.97
S1-800120	—	SF-489-T	1-1/8 ODF	48	12.42	3	3	N/A	N/A	16	190.37

Types Without Bypass Relief Valve (Single Flow Direction)

SOURCE 1 PART NO.	SPORLAN PART NO.		CONN	FILTER AREA SQ. IN.	OVERALL LENGTH	SHELL DIA	SHIP WT (LBS.)	RATINGS AT ARI STANDARD 730 CONDITIONS			MLP \$
	W/O ACCESS VALVE	W/ ACCESS VALVE						WATER CAP DROPS @ 60 PPM 75°F	WATER CAP DROPS @ 60 PPM 125°F	REFRIG FLOW CAP TONS @ 3 PSI	
S1-800013	SF-115		5/8 ODF	11	4.60	2.00	.75	N/A	N/A	4.1	63.43
S1-800182	—	SF-6417-T	2-1/8 ODF	388*	10.94	4.75	7.50	N/A	N/A	91.1	429.32

SELECTION RECOMMENDATIONS																		
TYPE NUMBER		CONNECTIONS INCHES	** FLOW CAPACITY IN TONS EVAPORATOR TEMPERATURE												NOMINAL SYSTEM HORSEPOWER			
WITHOUT ACCESS VALVE	WITH ACCESS VALVE		40°F				20°F				0°F		-20°F				-40°F	
			PRESSURE DROP															
			2	3	1/2	2	1	1-1/2	1/2	1	1/2	REFRIGERANT						
12	134A	22	12	134A	22	12	134	22	12	22	22	22	12, 134A, 502					
SF-114	--	1/2 ODF	1.3	1.5	2.4	0.9	1	1.5	0.6	0.6	1.1	0.3	0.7	0.3	1	1/2		
SF-115	--	5/8 ODF	2.3	2.6	4.1	1.6	1.7	2.7	1	1.1	1.8	0.5	1.2	0.6	2	1		
--	SF-285-T	5/8 ODF	3.5	4	6.4	2.5	2.7	4	1.6	1.7	2.9	0.9	1.8	1	4	1-1/2		
--	SF-286-T	3/4 ODF	4.3	5.1	8.6	3.1	3.4	5	2	2.1	3.6	1.1	2.2	1.2	5	1-1/2		
--	SF-287-T	7/8 ODF	6.3	7	11.1	4.4	4.6	7.2	2.7	2.8	5.1	1.4	3.1	1.5	7-1/2	3		
--	SF-289-T	1-1/8 ODF	8.2	9.2	14.8	5.7	6	9.4	3.5	3.7	6.6	1.8	4	2.1	7-1/2	5		
--	SF-489-T	1-1/8 ODF	8.7	9.9	16	6.1	6.5	10	3.7	3.9	7	1.9	4.3	2.2	10	5		
--	SF-4811-T	1-3/8 ODF	9.9	11.2	18.4	6.8	7.3	11.4	4.2	4.4	7.9	2.2	4.8	2.5	12	5		
--	SF-4813-T	1-5/8 ODF	11.7	13.3	21.6	8.1	8.7	13.5	4.9	5.2	9.4	2.6	5.6	2.9	15	7		
--	SF-6417-T	2-1/8 ODF	46.7	50.9	91.1	28.7	31	56.9	15.8	16.4	31.8	7.2	20.3	9.3	55	20		
--	SF-6421-T	2-5/8 ODF	50.5	62.9	119	36.8	38.6	70.2	20.2	20.6	44	9.1	25.6	11.8	60	30		

*Refrigerant 502 flow capacity is 80% of the values shown for Refrigerant 22, when expressed in TONS. When expressed in horsepower, the proper refrigerant selection is the same as for R-12.

* The SF-6400 series uses a pleated filter that greatly increases the square inch filter area.

Danfoss Universal TR 6 Expansion Valve Kits



The Danfoss Universal TR 6 thermostatic expansion valve (TXV) is available in seven models that cover original equipment manufacturer (OEM) air-conditioner and heat pump designs, from 1 1/2 to 6 tons in R-22 and R-410A systems.

Kit Includes:

- Valve with 3/8" x 3/8" ODF connections, 24" equalization line and 31 1/2" capillary tube
- Chatleff and Aeroquip adapters
- Built-in check valve for heat pumps
- 35" foam insulating tape
- Patented easy secure copper bulb strap Instructions

SOURCE 1 PART NO.	SYSTEM CAPACITY	DANFOSS MODEL	REFRIGERANT	MLP \$
S1-067L5856	1-1/2 - 2 TONS	067L5856	R22	201.68
S1-067L5857	2-1/2 - 3 TONS	067L5857	R22	201.68
S1-067L5858	3-1/2 - 4 TONS	067L5858	R22	201.68
S1-067L5859	5 - 6 TONS	067L5859	R22	197.80
S1-067L5955	1-1/2 - 2 TONS	067L5955	R410A	201.68
S1-067L5956	3-1/2 - 4 TONS	067L5956	R410A	201.68
S1-067L5957	4-1/2 - 5 TONS	067L5957	R410A	201.68

Air Conditioning & Refrigeration Controls

THERMOSTATIC EXPANSION VALVES

Sporlan "O" Series Expansion Valves



Sporlan Type O valve is a brass bar body, externally adjustable valve with ODF solder connections. The thermostatic element is replaceable, and the inlet connection has a permanent 12 mesh strainer. This valve type features a balanced port construction, and it is designed for both air conditioning and refrigeration applications. A synthetic seating surface provides tight shut-off during system off periods. This valve type has two body styles: a small body which provides capacities up to 30 tons R-22, and a large body which extends capacities to 70 tons R-22.

Features:

- Balanced port construction
- External equalizer with 1/4" ODF connection
- Connections in straight through flow configuration
- Remote bulb tubing length 60" (152 cm)
- Standard factory air test superheat setting at 7° F

SOURCE 1 PART NO.	SPORLAN PART NO.	REFRIGERANT	CAPACITY RANGE TONS	CONNECTION SIZE		SHIP WT. (LBS)	MLP \$
				INLET	OUTLET		
S1-124226	OVE-15-GA-7/8 X 1-1/8 X 1/4 X 5'	R22	15	7/8 ODF	1-1/8 ODF	3.00	482.98
S1-124233	OVE-20-GA-7/8 X 1-3/8 X 1/4 X 5'	R22	20	7/8 ODF	1-3/8 ODF	3.00	496.67
S1-124240	OVE-30-GA-1-1/8 X 1-3/8 X 1/4 X 5'	R22	30	1-1/8 ODF	1-3/8 ODF	3.00	496.67
S1-124247	OVE-40-GA-1-1/8 X 1-3/8 X 1/4 X 5'	R22	40	1-1/8 ODF	1-3/8 ODF	5.00	896.69
S1-124261	OVE-55-GA-1-1/8 X 1-3/8 X 1/4 X 5'	R22	55	1-1/8 ODF	1-3/8 ODF	5.00	896.69
S1-125396	OZE-20-GA, 7 X 9 ODF, 60"	R410A	20	7/8 ODF	1-3/8 ODF	3.00	722.49
S1-SV-125385	OZE-25-GA, 7/8 X 1 1/8 ODF, 5'	R410A	25	7/8 ODF	1-1/8 ODF	2.00	722.49

Sporlan "S" Series Expansion Valves



Sporlan Type S valve is a brass bar body, externally adjustable valve with ODF solder connections. The thermostatic element is replaceable and the inlet connection has a permanent 12 mesh strainer. This valve is designed for both air conditioning and refrigeration applications.

Features:

- External equalizer with 1/4" ODF connection
- Connections in straight through flow configuration
- Remote bulb tubing length 60" (152 cm)
- Standard factory air test superheat setting at 7° F

SOURCE 1 PART NO.	SPORLAN PART NO.	REFRIGERANT	CAPACITY RANGE TONS	CONNECTION SIZE		SHIP WT. (LBS)	MLP \$
				INLET	OUTLET		
S1-129054	SVE-2-GA-1/2 X 5/8 X 1/4 X 5'	R22	2	1/2 ODF	5/8 ODF	3.00	661.43
S1-129118	SVE-3-GA-1/2 X 5/8 X 1/4 X 5'	R22	3	1/2 ODF	5/8 ODF	3.00	396.92
S1-129201	SVE-4-GA-1/2 X 7/8 X 1/4 X 5'	R22	4	1/2 ODF	7/8 ODF	3.00	396.92
S1-129334	SVE-8-GA-5/8 X 7/8 X 1/4 X 5'	R22	8	5/8 ODF	7/8 ODF	3.00	338.09
S1-129383	SVE-10-GA-5/8 X 7/8 X 1/4 X 5'	R22	10	5/8 ODF	7/8 ODF	3.00	396.92

Sporlan EBSVE Series Expansion Valves



Features:

- Brass body
- Balanced port construction
- Extended ODF solder connections
- Suitable for large A/C applications which operate over widely-varying conditions
- Long-lasting stainless steel diaphragm
- Externally adjustable superheat

SOURCE 1 PART NO.	SPORLAN PART NO.	REFRIGERANT	CAPACITY RANGE TONS	CONNECTION SIZE		SHIP WT. (LBS)	MLP \$
				INLET	OUTLET		
S1-163556	EBSVE-8-GA, 5/8 X 7/8 ODF, 60"	R22	8	5/8	7/8	1.5	399.51
S1-163773	EBSVE-11-GA, 5/8 X 7/8 ODF, 60"	R22	11	5/8	7/8	1.5	399.51

Sporlan ERZE Series Expansion Valves



Sporlan RZE Series Expansion Valves The RZE valve is an externally adjustable balance ported TEV designed for R-410A air conditioning applications. This makes the RZE valve an excellent replacement for all OEM BI and BBI valves as well as other applications requiring a R-410A expansion valve such as I and RI valves. The RZE valve utilizes the KT-45 element design for the higher pressures of R-410A. This valve may also be applied in bi-directional applications.

SOURCE 1 PART NO.	SPORLAN PART NO.	REFRIGERANT	CAPACITY RANGE TONS	CONNECTION SIZE		SHIP WT. (LBS)	MLP \$
				INLET	OUTLET		
S1-168719	ERZE-8-GA, 5 X 7 ODF	R410A	8	5/8	7/8	1.5	343.13
S1-168720	ERZE-15-GA, 5 X 7 ODF	R410A	15	5/8	7/8	1.5	343.13
S1-168794	ERZE-6-GA	R410A	6	1/2	5/8		238.19
S1-168802	ERZE-12.5-GA, 5 X 9 ODF	R410A	12.5	5/8	1-1/8	1.5	343.13

Air Conditioning & Refrigeration Controls

THERMOSTATIC EXPANSION VALVES

Sporlan RC Series Expansion Valves



Small brass body, externally adjustable valve available for R-22 and R-410 air conditioning and heat pump applications. The valve contains an internal check valve to eliminate the need for external bypass check valve on heat pump applications. Suitable for replacing OEM type TEVs with or without internal check valve on these applications.

SOURCE 1 PART NO.	SPORLAN PART NO.	REFRIGERANT	CAPACITY RANGE TONS	CONNECTION SIZE		SHIP WT. (LBS)	MLP \$
				INLET	OUTLET		
S1-151245	RCVE-3-GA,3/8 X 1/2 ODF,30"	R22	3	3/8	1/2	1.5	258.57
S1-151252	RCVE-4-GA,1/2 X 1/2 ODF,30"	R22	4	1/2	1/2	1.5	258.57
S1-151253	RCVE-2-GA,3/8 X 1/2 SAE,30"	R22	2	3/8	1/2	1.5	332.94
S1-151258	RCVE-5-GA,1/2 X 1/2 ODF,30"	R22	5	1/2	1/2	1.5	258.57
S1-151265	RCVE-2-GA,3/8 X 1/2 ODF,30"	R22	2	3/8	1/2	1.5	303.34
S1-151270	RCVE-5-GA,1/2 X 1/2 SAE,30"	R22	5	1/2	1/2	1.5	340.75
S1-151277	RCVE-3-GA,3/8 X 1/2 SAE,30"	R22	3	3/8	1/2	1.5	332.94
S1-151365	RCZE-2-GA,3/8 X 1/2 ODF,30"	R410A	2	3/8	1/2	1.5	316.38
S1-151366	RCZE-3-GA,3/8 X 1/2 ODF,30"	R410A	3	3/8	1/2	1.5	316.38
S1-151368	RCZE-4-GA,1/2 X 1/2 ODF,30"	R410A	4	1/2	1/2	1.5	316.38
S1-151492	RCZE-5-GA,1/2 X 1/2 ODF,30"	R410A	5	1/2	1/2	1.5	416.93

SOLENOID VALVES AND COILS

Sporlan "E" Series Solenoid Valves



Features:

- Solenoid Valve Coil not included
- Extended connections
- Normally closed

Application:

- Mounted vertical, horizontal, or side
- Installation without disassembly

SOURCE 1 PART NO.	SPORLAN PART NO.	REFRIGERANT	CONN	PORT SIZE	NOMINAL CAPACITY @ 2 PSI	DIM				SHIP WT. (LBS)	USE COIL KIT	MLP \$
						A	B	C	D			
S1-3217-00	E3S120	R-22	1/4 ODF	0.094	1.3	4.63	0.55	2.04	0.29	1	MKC-1	131.91
S1-3227-00	E3S130	R-22	3/8 ODF	0.094	1.3	4.56	0.49	2.1	0.19	2	MKC-1	131.91
S1-3233-00	E6S130-HP	R410A	3/8 ODF	0.188	4	4.63	0.75	2.44	0.31	1.2	MKC-1	153.47
S1-3246-00	E5S130	R-22	3/8 ODF	0.156	2.8	4.56	0.53	2.48	0.23	1.2	MKC-1	131.91
S1-3284-00	E6S130	R-22	3/8 ODF	0.188	4	4.63	0.75	2.44	0.31	1.2	MKC-1	158.03
S1-3291-00	E6S140	R-22	1/2 ODF	0.188	4	5	0.75	2.44	0.31	1.2	MKC-1	158.03
S1-3368-00	E9S240	R-22	1/2 ODF	0.281	6.6	5	0.75	2.7	0.31	1.7	MKC-2	208.70
S1-3402-00	E9S250-HP	R410A	5/8 ODF	0.281	6.6	6.5	0.69	2.24	0.31	1.7	MKC-2	202.68
S1-3441-00	E10S250	R-22	5/8 ODF	0.313	9.1	6.5	0.86	3.13	0.39	2.3	MKC-2	246.95
S1-3505-00	E14S250	R-22	5/8 ODF	0.438	12.9	6.88	0.47	3.25	—	2.3	MKC-2	267.96
S1-3525-00	E10S240-HP	R410A	1/2 ODF	0.313	9.1	5	0.86	3.13	0.39	2.3	MKC-2	239.91
S1-3576-00	E19S270	R-22	7/8 ODF	0.594	19.8	7.13	0.81	3.41	—	2.6	MKC-2	436.23
S1-4033-00	E9S240-HP	R410A	1/2 ODF	0.281	6.6	5	0.75	2.7	0.31	1.7	MKC-2	202.68
S1-4077-00	E19S270-HP	R410A	7/8 ODF	0.594	19.8	7.13	0.81	3.41	—	2.6	MKC-2	411.39
S1-4079-00	E5S130-HP	R410A	3/8 ODF	0.156	2.8	4.56	0.53	2.48	0.23	1.2	MKC-1	129.43
S1-4100-00	E14S250-HP	R410A	5/8 ODF	0.438	12.9	6.88	0.47	3.25	—	2.3	MKC-2	260.28
S1-4101-00	E2S120-HP	R410A	1/4 ODF	0.075	0.95	4.63	0.55	1.96	0.31	1	MKC-1	129.43

Sporlan "CE6-HP" Series Solenoid Valves



For Refrigerants 22, 134a, 401A, 402A, 404A, 407C, 407F, 410A, 507

- Bi-Directional Solenoid Valve
- Supermarket Pumpdown Control
- Prevents Heat Pump Refrigerant Migration
- Extended Solder Type Connections
- MKC-1 Coil, Class F

SOURCE 1 PART NO.	SPORLAN PART NO.	REFRIGERANT	CONN	PORT SIZE	USE COIL KIT	MLP \$
S1-SV-4054-00	CE6S130-HP	ALL COMMON CFC, HCFC, HFC	3/8 ODF	0.197"	MKC-1	277.77

Air Conditioning & Refrigeration Controls

SOLENOID VALVES AND COILS

Sporlan "ME" Series Solenoid Valves



Features:

- With manual lift stem
- Solenoid Valve Coil not included
- Normally closed, Extended connections
- Application:
- Mounted vertical, horizontal or side
- Installation without disassembly



AIR CONDITIONING & HEATING CONTROLS

SOURCE 1 PART NO.	SPORLAN PART NO.	REFRIGERANT	CONN	PORT SIZE	NOMINAL CAPACITY @ PSI (TONS) (R22)	DIM A	SHIP WT (LBS)	USE COIL KIT	MLP \$
S1-3310-00	ME6S130-HP	R410A	3/8 ODF	0.188	4.0	4.63	1.25	MKC-1	204.14
S1-3315-00	ME6S130	R22	3/8 ODF	0.188	4.0	4.63	1.25	MKC-1	210.26
S1-3322-00	ME6S140	R22	1/2 ODF	0.188	4.0	5.0	1.25	MKC-1	210.26
S1-3390-00	ME9S230	R22	3/8 ODF	0.281	6.6	4.63	1.75	MKC-2	245.23
S1-3394-00	ME9S240-HP	R410A	1/2 ODF	0.281	6.6	5.00	1.75	MKC-2	254.86
S1-3396-00	ME9S240	R22	1/2 ODF	0.281	6.6	5.00	1.75	MKC-2	236.03
S1-4341-00	ME10S140-HP	ALL COMMON CFC,HCFC,HFC	1/2 ODF	5/16"	10.9	5.00	2.00	MKC-1	269.10
S1-3460-00	ME10S240	R22	1/2 ODF	0.313	9.1	5.00	2.00	MKC-2	298.72
S1-3466-00	ME10S250	R22	5/8 ODF	0.313	9.1	6.50	2.00	MKC-2	279.11
S1-3500-00	ME10S250-HP	ALL COMMON CFC,HCFC,HFC	5/8 ODF	5/16"	9.1	6.5	1.20	MKC-2	290.05
S1-3524-00	ME14S250-HP	R410A	5/8 ODF	0.458	12.9	6.88	2.25	MKC-2	304.51
S1-3528-00	ME14S250	R22	5/8 ODF	0.438	12.9	6.88	2.25	MKC-2	322.97
S1-3591-00	ME19S270-HP	R410A	7/8 ODF	0.594	19.8	7.13	3.75	MKC-2	463.08
S1-3596-00	ME19S270	R22	7/8 ODF	0.594	19.8	7.13	3.75	MKC-2	486.36
S1-3666-00	ME25S270	R22	7/8 ODF	0.781	33.7	7.50	6.00	MKC-2	681.50
S1-3672-00	ME25S290	R22	1-1/8 ODF	0.781	33.7	8.50	6.00	MKC-2	681.50
S1-4036-00	ME25S290-HP	R410A	1-1/8 ODF	0.781	33.7	8.50	6.00	MKC-2	648.90
S1-SV-406200	ME35S1110-HP	ALL COMMON CFC,HCFC,HFC	1-3/8 ODF	1"	56.8	11.06	5.30	MKC-1	970.97
S1-4076-00	ME6S140-HP	R410A	1/2 ODF	0.188	4.0	5.00	1.25	MKC-1	231.09
S1-4145-00	ME19S250-HP	ALL COMMON CFC,HCFC,HFC	5/8 ODF	19/32"	19.8	6.88	1.94	MKC-2	463.08
S1-4147-00	ME25S270-HP	ALL COMMON CFC,HCFC,HFC	7/8 ODF	25/32"	33.8	7.5	2.36	MKC-2	648.90
S1-4293-00	ME9S230-HP	ALL COMMON CFC,HCFC,HFC	3/8 ODF	9/32"	6.60	4.63	0.92	MKC-2	254.86

Sporlan Replacement Solenoid Valve Coil Kit

MKC-1 & MKC-2



Features:

- Designed for continuous duty
- Supplied with junction box
- Electrical specifications listed on coil & nameplate
- Blue lead wire

SOURCE 1 PART NO.	SPORLAN MODEL NO.	VOLTS / HZ	WATTS	VA		MLP \$
				HOLDING	INRUSH	
S1-310000	MKC-1,120V/50-60HZ,10W	120 VOLT 50/60 HZ	10	0.14	0.39	94.42
S1-310156	MKC-1, 208-240V/50-60HZ, 10W	208-240 VOLT 50/60 HZ	10	0.09	0.19	94.42
S1-310286	MKC-1,DUAL JAU*	120/208-240 50/60 HZ	10	.14/.09	.39/.19	123.38
S1-310325	MKC-1,24V/50-60HZ,10W	24 VOLT 50/60 HZ	10	0.63	1.9	94.42
S1-311424	MKC-2,120V/50-60HZ,10W	120 VOLT 50/60 HZ	15	0.26	0.6	115.59
S1-311515	MKC-2,208-240V/50-60HZ,10W	208-240 VOLT 50/60 HZ	15	0.13	0.31	115.59
S1-311671	MKC-2,DUAL JAU*	120/208-240 50/60 HZ	15	.23/.13	.60/.31	147.97
S1-311710	MKC-2,24V/50-60HZ,10W	24 VOLT 50/60 HZ	15	1.4	3.1	115.59

* J = JUNCTION BOX, A = 1/32" INSULATION

Sporlan Check Valves

SOURCE 1 PART NO.	CONNECTION SIZE	MLP \$
S1-274001-10	3/8 SWEAT	15.30
S1-274003-10	1/2 SWEAT	18.98
S1-274004-10	5/8 SWEAT	34.06
S1-274005-10	7/8 SWEAT	49.01
S1-274006-10	1-1/8 SWEAT	64.43

Air Conditioning & Refrigeration Controls

REFRIGERATION BALL VALVES

Sporlan EBV Refrigeration Ball Valves



Features:

- Forged brass body construction with extended copper fittings
- Full-size ports for unrestricted flow on most sizes (1/4" through 3-1/8")
- Dual Teflon seals surround the polished, brass ball with a secondary seal to prevent leakage due to foreign material
- Dual Teflon stem seals with internal packing nut for the primary seal; no synthetic "O" rings
- Fully open to fully closed with a 1/4-turn
- Positive movement ensured with internal, forged mechanical stops
- No need to remove the seal cap to open or close the valve
- Ball internal relief port design ensures positive shut-off in either flow direction—even during system evacuation
- Full refrigeration service temperature range: -40°F to 325°F (-40°C to 149°C)
- Design working pressure: 700 psig

SOURCE 1 PART NO.	SPORLAN MODEL NO	CONNECTION SIZE	MLP \$
S1-SV-502029	EBV-1020	1/4 SWEAT	78.98
S1-502031	EBV-1030	3/8 SWEAT	78.87
S1-502033	EBV-1040	1/2 SWEAT	78.40
S1-502035	EBV-1050	5/8 SWEAT	86.40
S1-SV-502037	EBV-1060	3/4 SWEAT	118.07
S1-502039	EBV-1070	7/8 SWEAT	112.46
S1-502041	EBV-1090	1-1/8 SWEAT	170.45

Sporlan EBVT Refrigeration Ball Valves

SOURCE 1 PART NO.	SPORLAN MODEL NO	CONNECTION SIZE	MLP \$
S1-SV-502030	EBVT-1020	1/4 SWEAT	88.60
S1-SV-502032	EBVT-1030	3/8 SWEAT	88.37
S1-SV-502034	EBVT-1040	1/2 SWEAT	87.93
S1-SV-502036	EBVT-1050	5/8 SWEAT	95.99
S1-SV-502038	EBVT-1060	3/4 SWEAT	122.10
S1-SV-502040	EBVT-1070	7/8 SWEAT	122.10
S1-SV-502042	EBVT-1090	1-1/8 SWEAT	179.96
S1-SV-502044	EBVT-1110	1-3/8 SWEAT	290.91
S1-SV-502046	EBVT-1130	1-5/8 SWEAT	325.75

Gas Heating Controls

WHITE RODGERS GAS VALVES

36H Series Universal Fast Open High Capacity Gas Valves



36H valves are used for proven pilot applications, and can replace more than 93 valves in the 36C68/36C76 series. Improvements over the 36C series include: field convertible from Natural to LP, independently field adjustable two-stage regulators and electric on/off switch.

Features:

- 320K BTU at 1" pressure drop versus 280K BTU at 1" for the 36C series
- Diaphragm size increased 15% over 36C series resulting in improved regulation set point stability
- Quiet design, DC rectified
- Independently adjustable high/low two stage
- Direct ignition or proven pilot
- 24 volt, 50/60 Hz
- 0.75" x 0.75"; 0.25" press tap in and out
- 50k-400k BTU range of regulation
- Straight through design

SOURCE 1 PART NO.	STAGES	MLP \$
S1-36H32-214	SINGLE	301.28
S1-36H32-304	SINGLE	337.79
S1-36H32-423	SINGLE	341.23
S1-36H33-412	SINGLE	356.89
S1-36H64-463	TWO	434.74

Conversion Kits for White Rodgers Gas Valves

SOURCE 1 PART NO.	TYPE OF CONVERSION	USED WITH VALVE TYPE	MLP \$
S1-F92-0656	PROPANE TO NATURAL	36C, 36E, 36J VALVES W/ REGULATOR RANGE OF 2.5" TO 5.0" W.C.	16.95

Gas Heating Controls

WHITE RODGERS GAS VALVES

AIR CONDITIONING & HEATING CONTROLS

SOURCE 1 PART NO.	REPLACES							
S1-36H32-304	36E36-304							
S1-36H33-412	36C81 410S1	36E24 203P1	36E24 206P1	36E24 209B1	36E24 211B1	36E52 214JS	36E98 202B1	36E98 304GR
	36C81 451B1	36E24 203B1	36E24 206S1	36E24 209P1	36E24 211S1	36E92 201S1	36E98 204S1	36H23-401B1
	36C81 451P1	36E24 204B1	36E24 207B1	36E24 210B1	36E24 212B1	36E92 201B1	36E98 206B1	36H23-402P1
	36C81 451S1	36E24 204P1	36E24 207P1	36E24 210P1	36E24 214JS	36E98 201P1	36E98 206S1	36H33 313B1
	36E24 202B1	36E24 205S1	36E24 207S1	36E24 211P1	36E24 214B1	36E98 201B1	36E98 206P1	36H33 314B1
	36E24 202P1	36E24 205P1	36E24 208S1	36E24 211S1	36E24 214S1	36E98 201S1	36E98 301B1	36H33 415B1
	36E24 202S1	36E24 205B1	36E24 208P1	36E24 211P1	36E24 218P1	36E98 202S1	36E98 304S1	36H33 416B1
	36E24 203S1	36E24 206B1	36E24 208B1	36E24 211B1	36E52 214S1	36E98 202P1	36E98 304JS	
S1-36H65-401	36E96 227P1	36E96 231S1	36E96 231B1	36E96 234B1	36E96 238B1	36E96 314JS	36H55-201B1	36H55-403B1
	36E96 227B1	36E96 231P1	36E96 234P1	36E96 238P1	36E96 257B1	36E96 314S1	36H55-202B1	36H55-404P1
S1-36H32-423	36C68-200	36C68-218	36C68-303	36C68-400	36C68-419	36C68-452	36C68-601	700-420
	36C68-202	36C68-243	36C68-324	36C68-403	36C68-423	36C68-457	36C68-602	V845A1109
	36C68-205	36C68-261	36C68-325	36C68-404	36C68-434	36C68-464	36C68-606	VR8304M4507
	36C68-209	36C68-262	36C68-326	36C68-405	36C68-441	36C68-472	36C68-607	VR8345M4302
	36C68-212	36C68-266	36C68-327	36C68-415	36C68-442	36C68-473	36C68-806	
	36C68-217	36C68-301	36C68-330	36C68-418	36C68-448	36C68-477	700-418	
S1-36H64-463	1RC52	36C76-214	36C76-230	36C76-407	36C76-412	36C76-445	36C76-467	36D13-208
	36C76-205	36C76-225	36C76-401	36C76-408	36C76-417	36C76-459	36D13-208	36H64-463
	36C76-210	36C76-227	36C76-406	36C76-411	36C76-420	36C76-463	36D13-405	700-413

36J Series Universal Gas Valves



The 36J combination gas control valve is a versatile multifunction control designed to meet the requirements for use with non-piloted intermittent ignition systems (Direct Spark Ignition, Hot Surface Ignition). Models include fast and slow open single and two-stage valves. These valves are also convertible for natural/LP gases. Along with its reduced size, all control adjustments and features, as well as the system interface-wiring panel, have been designed on the top surface of the control for simplified application and easy accessibility.

Features:

- Patented coaxial solenoid design.
- Inlet and optional outlet screens help protect from debris.
- Controlled gasket compression.
- Tamper resistant screws.
- Built-in hose connections for simplified field service or Std. 1/8" NPT (optional).
- Conveniently located electric on-off switch.
- Versatile mounting.

SOURCE 1 PART NO.	STAGES	REPLACES	MLP \$
S1-36J22-214	SINGLE	36G22-214	190.95
S1-36J24-214	SINGLE	36G24-214	192.94
S1-36J54-214	TWO	36G54-214	278.08
S1-36J55-214	TWO	36G55-214	295.95

36C Replacement Gas Controls



Features:

- Valve may be mounted in any position, except upside down.
- Both main valve seat and line-interrupter seal with line pressure, assuring positive gas seal-off.
- Inlet screen, pilot gas filter and top operated main valve provide maximum protection against chips and dirt.
- Gas cock knob, pilot adjust screw and regulator adjustment are on top of control.
- Thermocouple connection on models with line interrupter and combination tab/screw terminals on 24 VAC models.
- For use with all gases. (All models include LP Conversion kits.)
- Model 36C03 (24V) is for use with thermocouple (H06E Series, p. 99).
- Model 36C03U is for use with 750 millivolt power generator (S1-G01A-332, p. 99) and may be used with 250 millivolt system if nonanticipated room thermostat is used. Must be used in vented application.

Specifications

Regulator Setting: Natural gas, 3-1/2" W.C.

Regulator Adjustment Range: 2-1/2" to 5" W.C.

Ambient Operating Range: -40 to +175° F (-40 to +79° C)

Maximum Pressure Rating: 1/2 PSI (14.0" W.C.)

Pilot Gas Connection: 1/4" compression fitting furnished.

Pressure Tap: 1/8" NPT.

Body Pattern: Straight through.

SOURCE 1 PART NO.	COIL VOLTAGE	INLET-OUTLET SIZE	CAPACITY AGA STANDARD GAS*	GAS	LP CONVERSION KIT	REDUCER BUSHING KIT	SIDE TAPS	LINE INTERRUPTER	INLET PRESSURE TAP	MLP \$
S1-36C03-300	24 VAC, 60 HZ	1/2 X 3/4	230,000	NAT	YES	YES	NO	YES	YES	271.47
S1-36C03-333	24 VAC, 60 HZ	1/2 X 3/4	230,000	NAT	YES	YES	YES	YES	YES	289.68
S1-36C03-400	24 VAC, 60 HZ	3/4 X 3/4	280,000	NAT	YES	YES	NO	YES	YES	338.98
S1-36C03-433	24 VAC, 60 HZ	3/4 X 3/4	280,000	NAT	YES	YES	YES	YES	YES	366.75
S1-36C03U-333	750 MV	1/2 X 3/4	230,000	NAT	YES	YES	YES	YES	YES	451.31

Gas Heating Controls

HONEYWELL GAS VALVES

V800 Standing Pilot Gas Valve



Used on gas fired standing pilot appliances with 30 mV thermocouple. These gas controls include a manual gas valve, safety shutoff, single millivoltage automatic operator, and pressure regulator, pilot gas filter and flowadjustment, pressure tapping, and thermocouple connector. V800 is used on 24V systems.

Features:

- Include pilot flow adjustment screw.
- Easy to install, adjust and service; all adjustments and connections are accessible from top of control.
- Add separate energy cutoff (ECO) where codes call for dual safety shutoff.
- Complete safety shutoff on pilot flame failure.
- LITE-RITE (OFF-PILOT-ON) lighting sequence.
- ECO connector for V800 models. Part No. 392451-1.

Specifications:

Type: Single Stage
Ignition Type: Standing Pilot
Type of Gas: Natural or LP
Body Pattern: Straight-through, multi-tapped with 1/2" right and left outlets plugged
Note: No side outlets on S1-VA800A1476.
Pressure Ratings (psi): 1/2 psi
Pressure Ratings (kPa): 3.5 kPa
Pilot Gas Outlet: Compression fitting for 1/4" OD tubing
Pressure Tapping: 1/8" NPT with plug
Electrical Ratings: 24 VAC
Frequency: 60 Hz

Anticipator Setting: .2 A

Temperature Range (F): 32°F to 175°F

Temperature Range (C): 0°C to 79°C

Mounting: 0 to 90 degrees in any direction from the upright position of the gas control knob, including vertically.

Dimensions (in.): 4-3/4"H x 4-1/16"W x 3-3/16"D

Dimensions (mm): 121 mm H x 103 mm W x 81 mm D

Approvals: American Gas Association IAS AGA Design Certified; File No. L2025003, CGA Design Certified; File No. L2025003, UL Component Recognized; Underwriters Laboratories Inc UL Component Recognized.

SOURCE 1 PART NO.	INLET-OUTLET SIZE	OPENING	CAP @ 1 IN P.D.	PRESSURE REGULATOR SETTING		ELECTRICAL CONNECTIONS	ACCESSORIES INCLUDED	MLP \$
				PSI	KPA			
S1-V800A1088	3/4 IN. x 3/4 IN.	STANDARD	335,000 BTU/HR	3.5 IN. WC	0.87 KPA	COMBINATION SCREW AND 1/4 IN. MALE QUICK CONNECTS	ONE Q340 THERMOCOUPLE, WO 3/4 x 1/2 IN REDUCER BUSHINGS, ONE 1/2 x 3/8 IN REDUCER BUSHING, AND NATURAL TO LP CONVERSION KIT	718.80

VR8200 Continuous Pilot Dual Automatic Combination Gas Valves



Combination gas controls for use in 24 VAC, gas-fired, standing pilot appliances with capacities from 20 to 200 cfh. Both include: 1/2" x 3/8" reducer bushing; 39369014 bag assembly—3/4" straight flange with O ring, screws and wrench; Q340 (39") thermocouple with adapters; and 393691 Natural to LP gas conversion kit. VR8200A2132 does not contain the thermocouple. The VR8200A2124 does.

- Control includes safety shutoff, a manual valve, two automatic operators, servo pressure regulator and pilot adjustment.
- Compact size.
- Provide two automatic valves.
- Solenoid-operated first automatic valve opens on thermostat call for heat; closes when call for heat ends.
- Diaphragm-operated second automatic valve opens under control of regulator; closes if gas or power supply is interrupted.
- Meet codes requiring dual safety shutoff.
- All adjustments, wiring connections and pilot outlet are accessible from top of control.
- Adjustable servo regulator effectively maintains almost constant gas output pressure under wide fluctuations in pressure gas supply.
- Compatible with ECO connector.
- VR8200 controls replace the following Honeywell and competitive combination gas controls for applications requiring a minimum
 - Capacity of 20 cfh and a maximum capacity of 200 cfh.
 - Honeywell V800A and VR800A models
 - White Rodgers 36C03/01 series
 - Robertshaw 7000BER (700-400) series
 - Robertshaw 7200BER (720-400) series
 - ITT B57 and B59 series
 - Essex SX242N

Approval Bodies:

AGA Design certified: File No. L2025006.

CGA Design certified: File No. L2025006.

UL Inc. component recognized: File No. MH5323.

Lite-Rite (Off-Pilot-On) lighting sequence.

Mounting: 0° to 90° in any direction from the upright position of gas control knob, including vertically.

Body Pattern: Straight-through with 1/2" inlets and outlets.

Pilot Gas Outlet: Compression fitting for 1/4" OD tubing.

Pressure Tapping: 1/8" NPT with plug

Pressure Rating: 1/2 PSI [3.5 kPa] inlet pressure.

Ambient Temperature Range: VR8200A: 0°F to 175°F [-18°C to +79°C].

Electrical Data:

Supply Voltage: 24 VAC, 60 Hz.

Wiring Connections: Combination screw and 1/4" male quick-connects.

Thermostat Heat Anticipator Setting: 0.5 A.

SOURCE 1 PART NO.	GAS TYPE	AMPS @ 24 VAC/60 HZ MAIN	PRESSURE SETTING MAIN	CAPACITY	INLET NPTI	OUTLET NPTI	PIPE IN DIM	MLP \$
S1-VR8200A2124	NAT	0.5	3.5	130,000 BTU/HR; 20,000 BTU-HR MIN	1/2	1/2	4.125	294.99
S1-VR8200A2132	NAT	0.5	3.5	130,000 BTU/HR; 20,000 BTU-HR MIN	1/2	1/2	4.125	280.95

Gas Heating Controls

HONEYWELL GAS VALVES

AIR CONDITIONING & HEATING CONTROLS

VR8204 Intermittent Pilot Dual Automatic Combination Gas Valves



Combination gas controls for use in 24 VAC, gas-fired intermittent pilot appliances with capacities from 20 to 200 cfh.

- Controls include manual valve, two automatic operators, servo pressure regulator and pilot adjustment.
- Use with S86F,H, S8600F,H and S8610 control modules.
- Compact size.
- Provide two automatic valves.
- Solenoid operated first automatic valve opens on thermostat call for heat; closes when call for heat ends.
- Diaphragm operated second automatic valve opens under control of regulator; closes if gas or power supply is interrupted.
- Meet codes requiring dual safety shutoff.

Approval Bodies:

AGA Design certified: File No. L2025006.

CGA Design certified: File No. L2025006.

Mounting: 0° to 90° from the upright position of gas control knob, including vertically.

Body Pattern: Straight-through with 1/2" inlets and outlets.

Pressure Tapping: 1/8" NPT with plug.

Pressure Rating: 1/2 PSI [3.5 kPa] inlet pressure.

Pilot Gas Outlet: Compression fitting for 1/4" OD tubing.

- Natural to LP gas conversion kits are available, but not included.
- All adjustments and wiring connections are accessible from top of control.
- VR8204 controls replace the following Honeywell and competitive combination gas controls for applications requiring a minimum
 - Honeywell VR8440
 - White Rodgers 36E36/38
 - Robertshaw 7100DER (700-070)
- capacity of 20 cfh and a maximum capacity of 200 cfh.

Ambient Temperature Range:

VR8204A,C: 0°F to 175°F [-18°C to +79°C].

VR8204M: -40°F to +175°F [-40°C to +79°C].

Electrical Data:

Supply Voltage: 24 VAC, 60 Hz.

Wiring Connections: 1/4" male quick-connects.

Thermostat Heat Anticipator Setting: 0.5A.

On-Off lighting sequence.

SOURCE 1 PART NO.	GAS TYPE	AMPS @ 24 VAC/60 HZ MAIN	PRESSURE REGULATOR SETTING		CAPACITY AT 1 IN. P.D.	INLET NPTI	OUTLET NPTI	PIPE IN DIM	MLP \$
			STEP	FULL					
S1-VR8204C1019	NAT	0.5	.9	3.5	150,000	1/2	1/2	4.1	421.21

VR8205A Direct Ignition Dual Automatic Combination Gas Valves



Combination gas control for use in 24 VAC, gas-fired, standing pilot appliances with capacities from 30 to 300 cfh.

Features:

- Controls include safety shutoff, manual valve, two automatic operators, pressure regulator and pilot adjustment.
- Compact size
- Provides two automatic valves.
- Solenoid operated first automatic valve opens on tstat call for heat; closes when call for heat ends.
- Diaphragm-operated second automatic valve opens under control of regulator; closes if gas or power supply is interrupted.
- Meets codes requiring dual safety shutoff.

Specifications:

Type: Single Stage

Ignition Type: Standing Pilot

Type of Gas: Natural

Body Pattern: Straight through with integral tapping; with flange

Opening Characteristics (standard, step): Standard

Pressure Ratings (psi): 1/2 psi

Pressure Ratings (kPa): 3.5 kPa

Pressure Regulator setting (psi): 3.5" W.C.

Pressure Regulator setting (kPa): 0.87 kPa

Pilot Gas Outlet: Compression fitting for 1/4" OD tubing

Pressure Tapping: 1/8" NPT with plug

Electrical Connections: 1/4" male quick-connects

- Standard and slow opening natural gas models include natural to LP gas conversion kit; LP to natural gas conversion kit also available.
- All adjustments, wiring connections and pilot outlet are accessible from top of control.
- Adjustable servo regulator effectively maintains almost constant gas output pressure under wide fluctuations in gas supply pressure.
- Comatible with ECO connector.
- LITE-RITE (OFF-PILOT-ON) LIGHTING SEQUENCES.

Electrical Ratings: 24 VAC

Frequency: 60 Hz

Anticipator Setting: 0.7 A

Temperature Range (F): 0°F to 175°F

Temperature Range (C): -18°C to +79°C

Mounting: 0 to 90 degrees in any direction from the upright position of the gas control knob, including vertically.

Dimensions (in.): 5-3/8"H x 4-1/16"W x 2-11/16"D

Dimensions (mm): 135 mm H x 104 mm W x 69 mm D

Approvals: AGA Design Certified: File No. L2025006; CGA Design Certified: File No. L2025006; UL Component Recognized.

SOURCE 1 PART NO.	INLET-OUTLET SIZE	CAPACITY @ 1 IN P.D.	ACCESSORIES INCLUDED	MLP \$
S1-VR8300A3500	1/2 IN. x 3/4 IN.	190,000 BTU/HR; 30,000 BTU/HR MINIMUM	ONE 3/4 x 1/2 IN. REDUCER BUSHING 393691 NATURAL TO LP GAS CONVERSION KIT	322.97
S1-VR8300A4508	3/4 IN. x 3/4 IN.	200,000 BTU/HR; 30,000 BTU/HR MINIMUM	TWO 3/4 x 1/2 IN. REDUCER BUSHING 393691 NATURAL TO LP GAS CONVERSION KIT	346.29

Gas Heating Controls

HONEYWELL GAS VALVES

VR8345 Universal Electronic Ignition Combination Gas Control



Features:

- For use with direct spark ignition, hot surface ignition or intermittent pilot ignition in 24 VAC, gas-fired appliances, with capacities from 30 to 415 cfh.
- For use with natural or manufactured gas or LP gas. Includes converter kit to adapt from natural to LP gas.
- Control includes: manual valve, two automatic operators, pressure regulator (3.5" WC), pilot adjustment, pilot plug and ignition adapter, two 3/4" x 1/2" NPT reducer bushings and one 1/2" x 3/8" NPT bushing.
- Replaces virtually any IP, HSI or DSI gas control.
- Clearly marked, keyed terminal block allows quick attachment of wires and IP/DSI/HIS jumper.
- Internal inlet screen blocks contaminants in gas line from entering valve.

Body Pattern: Straight-through with 3/4" x 3/4" inlet and outlet.

Dimensions: 5-3/8" H, 4-1/16" W, 2-11/16" D (135 mm H, 104 mm W, 69 mm D)

Approvals: AGA Design Certified: File number L2025007; CGA Design Certified: File number L2025007.

SOURCE 1 PART NO.	IGNITION	VOLT	OPENING	INLET-OUTLET SIZE	FUEL	MLP
S1-VR8345M4302	DIRECT/ INTERMITTENT PILOT	24	STANDARD	3/4 IN. x 3/4 IN.	NAT/LP	735.12

SV9502H2522 System Control



The SmartValve® System Controls provide easy field replacement of a wide range of SV9500, SV9501, SV9502 and SV9602 SmartValve System models. Gas appliance manufacturers use these models in many types of gas fired heating appliances including central furnaces, residential boilers, rooftop furnaces, commercial cooking appliances, and unit heaters. These controls provide intermittent pilot gas ignition sequencing, pilot flame sensing, and both pilot and main gas control functions in a single control. They are directly compatible with the Q3450 or Q3480 Intermittent Pilot burners used with the original controls on the appliance.

Features:

- Suitable for a wide range of gas-fired appliances including residential furnaces, roof-top furnaces, residential boilers, unit heaters, infrared heaters, space heaters and commercial cooking units.
- Replaces SV9500, SV9501 and SV9502 controls as noted below.
- Ignition sequence includes timed trial for ignition.

SOURCE 1 PART NO.	GAS TYPE	MLP
S1-SV9502H2522	SMART VALVE SYSTEM CONTROL	771.63

SV9501 SmartValve™ System Gas Valve



The SmartValve™ System Controls provide intermittent pilot gas ignition sequencing, pilot flame sensing, and both pilot and main gas control functions in a single control. They are directly compatible with the Q3450 or Q3480 intermittent pilot burners used with the original controls on many gas fired heating appliances.

Features:

- Suitable for a wide range of gas-fired appliances including residential furnaces, rooftop furnaces, residential boilers, unit heaters, infrared heaters, space heaters and commercial cooking units.
- Replaces some SV9500, SV9501 and SV9502 SmartValve™ System models.
- Ignition sequence includes timed trial for ignition.
- Pilot gas outlet

Specifications:

Flame Sense: Electrode

Ignition System Type: Intermittent hot surface pilot ignition

Ignition Sequence: Intermittent pilot

Ignition Source: Pilot

Ignition Trials to Lockout: Continuous retry

Ignition Trial Time: 90 sec.

Flame Failure Response Time: 1.6 sec. @ 3 µA

Prepurge: None

Body Pattern: Straight-through

Opening Characteristics: Standard opening

Ambient Temperature Range: -40° to +175°F (-40° to +79°C)

Electrical Ratings: 24 VAC

Frequency: 60 Hz/50 Hz

Approvals: American Gas Association IAS, IAS Design Certified: C2030017

SOURCE 1 PART NO.	GAS TYPE	PRESSURE REGULATOR SETTING	PRESSURE RATINGS	CAPACITY		INLET NPT	OUTLET NPT	MLP
				MAXIMUM	MINIMUM			
S1-SV9501M2528	NAT	3.5" WC (0.87 KPA)	1/2 PSI (3.45 KPA)	200 FT ³ /HR (5.7 M ³ /HR) 150 FT ³ /HR AT 1" P.D. (20 M ³ /HR AT 1" P.D.)	0.6 M ³ /HR	1/2"	1/2"	728.83

Gas Heating Controls

POWER GENERATORS, THERMOCOUPLES, HOT SURFACE IGNITERS, FLAME SENSORS

Honeywell Q340A Thermocouples



Q340A thermocouples sense the pilot flame on gas-fired heating systems. The pilot flame heats the tip of the thermocouple, producing a temperature differential between it and the base to generate a small amount of DC power, measured in millivolts.

Features:

- Push-in clip, split nut, and adapter assembly for easy pilot burner installation.
- Spade or quick-connect terminals available for millivolt gas control connections.
- Male nut connector for Pilotstat® safety control power units.
- Available in a variety of lead lengths.
- Adapter and Push In clip included

SOURCE 1 PART NO.	LEAD LENGTH	CONNECTION TYPE	RESISTANCE	MLP
S1-Q340A1066	18 IN.	11/32 32 MALE CONNECTOR NUT	0.02 OHMS	22.55
S1-Q340A1074	24 IN.	11/32 32 MALE CONNECTOR NUT; PUSH IN KIT	0.02 OHMS	23.53
S1-Q340A1090	36 IN.	11/32 32 MALE CONNECTOR NUT	0.02 OHMS	25.76
S1-Q340A1108	48 IN.	11/32 32 MALE CONNECTOR NUT	0.02 OHMS	28.56

Honeywell Pilot Burner for Natural Gas



Nonprimary-aerated combination pilot burner and igniter. Used with the S86, S860, S8610, or S8670 in intermittent pilot systems.

Features:

- Includes pilot burner with bracket, ceramic insulated Kanthal flame rod/spark igniter and ground strap.

Specifications:

Type of Gas: Natural

Direction of Front Tip: (F) Front

Tip Style: Single

Aeration: Non-primary

Leadwire Temperature Ratings (C): Max. at electrode tip: 968°C

Includes: 1/4" cc inlet fitting and mounting adapter

SOURCE 1 PART NO.	MOUNTING BRACKET	COMPRESSION FITTING LENGTH	ORIFICE	MLP
S1-Q345A1305	B	0.78 IN.	BCR-18 (0.018 IN.)	99.08

Honeywell Q313 Thermopile Generator



Q313 Thermopile Generator contains multiple thermocouples connected in series to increase the millivoltage output. The power generated is sufficient to operate an automatic millivolt gas control system, independent of any outside power source.

Features:

- Push-in clip, split nut, and adapter assembly for easy pilot burner installation.
- Spade or quick-connect terminals available for millivolt gas control connections.
- Male nut connector for Pilotstat® safety control power units.
- Available in a variety of lead lengths.

Specifications:

Voltage 750 mV

Connection Type Spade Terminals

Open Circuit Output (mV) 600 mV to 750 mV

Temperature Ratings (F) Hot Junction 1400 F

Temperature Ratings (C) Hot Junction 760 C

Temperature Ratings (F) Cold Junction 780 F

Temperature Ratings (C) Cold Junction 416 C

Used With Q314, Q324, Q327, Q377, Q379,

Q382 Pilot Burners

SOURCE 1 PART NO.	LEAD LENGTH	RESISTANCE	ACCESSORIES INCLUDED	MLP
S1-Q313A1170	35 IN (889 MM)	2.89 OHMS	PG9 ADAPTER AND 1/2 IN. THERMOPILE ATTACHING NUT	131.65

Honeywell Q314 Pilot Burners



Non primary-aerated, insert orifice type pilot burner for main burner ignition. Used with Q309, Q340, Q340 thermocouples or Q313 thermopiles.

Features:

- 1/4" Compression fitting.
- B style mounting bracket.
- Single tip style.
- Includes special mounting bracket with screws to convert B bracket to A bracket

SOURCE 1 PART NO.	FRONT TIP DIRECTION	MLP
S1-Q314A4586	FRONT	86.75
S1-Q314A6102	FRONT	87.35

Gas Heating Controls

POWER GENERATORS, THERMOCOUPLES, HOT SURFACE IGNITERS, FLAME SENSORS

White Rodgers Universal Replacement Thermocouples



High temperature stainless steel element specially designed for universal replacement.

Features:

- Stainless steel element construction for prolonged thermocouple life.
- Each kit individually enclosed in plastic.
- Universal adapter fittings included with each kit for replacing thermocouple in most types of pilot burners.
- Visible instructions for quick, easy installation.

SOURCE 1 PART NO.	DESCRIPTION	MLP
S1-H06E-18	UNIVERSAL 18" THERMOCOUPLE	13.09
S1-H06E-24	UNIVERSAL 24" THERMOCOUPLE	13.75
S1-H06E-30	UNIVERSAL 30" THERMOCOUPLE	14.48
S1-H06E-36	UNIVERSAL 36" THERMOCOUPLE	15.10
S1-H06E-48	UNIVERSAL 48" THERMOCOUPLE	17.48
S1-H06E-72	UNIVERSAL 72" THERMOCOUPLE	27.46

White Rodgers 750 Millivolt Power Generator



Provides power for 750 millivolt self-generation control systems.

Features:

- For replacement of similar screw-in type generators now in field or for use with type E31- 12 pilot burner.
- G01A-332 has 36 inch armored cable leads with split-spade terminals.
- PG9 Adapter included with each G01A-332.

SOURCE 1 PART NO.	DESCRIPTION	MLP
S1-G01A-332	750 MV W/36" LEADS (ARMORED CABLE) AND PG9 ADAPTER	126.97
S1-G01A-512	750 MV W/36" LEADS (FIBERGLASS) WITH F SPADE CLIPS	104.27

Gas Heating Controls

POWER GENERATORS, THERMOCOUPLES, HOT SURFACE IGNITERS, FLAME SENSORS

SOURCE 1® Silicon Carbide Igniters



Source 1's hot surface igniters are made of high purity recrystallized silicon carbide to provide reliable ignition in a variety of heating systems.

- Replaces Carrier, Lennox, Rheem, Trane, and others
- Can reach ignition temperature(s) in 17 seconds
- 18-gauge nickel chrome lead wires enclosed with high-temperature fiberglass insulation
- Compare to Robertshaw R 41-400 Series
- See following table for cross-reference information.

SOURCE 1 PART NO.	DESCRIPTION	MLP
S1-HSI-401	IGNITER,HOT SURFACE,401,5.5 INCH LEAD	43.93
S1-HSI-402	IGNITER,HOT SURFACE,402,19.125 INCH LEAD	42.68
S1-HSI-403	IGNITER,HOT SURFACE,403,5.5 INCH LEAD	39.36
S1-HSI-404	IGNITER,HOT SURFACE,404,5.25 INCH LEAD	51.00
S1-HSI-405	IGNITER,HOT SURFACE,405,5.5 INCH LEAD	43.93
S1-HSI-406	IGNITER,HOT SURFACE,406,11 INCH LEAD	44.16
S1-HSI-407	IGNITER,HOT SURFACE,407,5 INCH LEAD	39.36
S1-HSI-408	IGNITER,HOT SURFACE,408,5.25 INCH LEAD	41.07
S1-HSI-409	IGNITER,HOT SURFACE,409,5.25 INCH LEAD	39.36
S1-HSI-410	IGNITER,HOT SURFACE,410,4.5 INCH LEAD	41.07
S1-HSI-411	IGNITER,HOT SURFACE,411,5.25 INCH LEAD	43.93
S1-HSI-412	IGNITER,HOT SURFACE,412,5.25 INCH LEAD	42.68
S1-HSI-414	IGNITER,HOT SURFACE,414,5.25 INCH LEAD	47.69
S1-HSI-418	IGNITER,HOT SURFACE,418,5.25 INCH LEAD	43.93

OEM PART NO.	SOURCE 1 PART NO.	OEM PART NO.	SOURCE 1 PART NO.	OEM PART NO.	SOURCE 1 PART NO.
AMANA		MODINE		ROBERTS GORDON	
B1336102	S1-HSI-401	5H75032	N/A	90434300	S1-HSI-409
D99182	S1-HSI-401*	MOR-FLO		904366600	S1-HSI-402
10041601	S1-HSI-401*	3200580	S1-HSI-406*	SMITH HB	
AMERICAN APPLIANCE		3200618	S1-HSI-402	50018	S1-HSI-405*
271B	S1-HSI-406*	3210401	S1-HSI-406	SYNDER GENERAL	
AMERICAN ROAD EQUIPMENT		NORDYNE		1380672	S1-HSI-409*
201W	S1-HSI-402	105141000	S1-HSI-402	1380680	S1-HSI-409*
ARMSTRONG AIR		632-0880	S1-HSI-402	1380654	S1-HSI-403
3822B001	S1-HSI-402	632-0770	S1-HSI-402	TRANE COMPANY	
CARRIER CORP		FC007	N/A	B138196P01	S1-HSI-403
LH33ZS001A	S1-HSI-409*	902661	N/A	B144676P02	S1-HSI-407*
LH33ZS002	S1-HSI-409*	FC047K	N/A	B340039P01	S1-HSI-408*
COLEMAN/EVCON		903110	N/A	340039P01	S1-HSI-402
1474-051	S1-HSI-402	NORTON		IGN21	
1474-052	S1-HSI-402	201	S1-HSI-403	IGN23	S1-HSI-402
COMFORT ZONE		201A	S1-HSI-401	IGN26	S1-HSI-409*
150114-04-01	S1-HSI-406	201D	S1-HSI-405	IGN26	S1-HSI-403
DETROIT RADIANT		201J	S1-HSI-406	IGN30	S1-HSI-407*
201D	S1-HSI-405	201K	S1-HSI-402	IGN30	S1-HSI-403
DMO INDUSTRIES		201L	S1-HSI-402	3033 KIT	N/A
20834	S1-HSI-402	201N	S1-HSI-402	VIESSMAN	
DORNBACK FURNACE		201R	S1-HSI-402	9302-094	S1-HSI-405
271W	S1-HSI-402	201W	S1-HSI-402	WAYNE HOME EQUIPMENT	
DUCANE		201Y	S1-HSI-406	62821-001	S1-HSI-402
20015201	S1-HSI-409*	271	S1-HSI-403	62821-002	S1-HSI-402
ENERCO TECH		271A	S1-HSI-401	WELL MCLAIN	
10399	S1-HSI-402	271P	S1-HSI-405	511-330-139	S1-HSI-409*
GOODMAN		271M	S1-HSI-406	511-330-188	S1-HSI-406*
B1401009	S1-HSI-412*	271N	S1-HSI-402	511-330-193	S1-HSI-403
B1401015S	N/A	271NM	S1-HSI-412	WILLIAMSON	
B1401018S	S1-HSI-418	271W	S1-HSI-402	9050	S1-HSI-402
B1401015	S1-HSI-418	271Y	S1-HSI-406	YORK INTERNATIONAL	
HUPP INDUSTRIES		PERFECTION SCHWANK		025-27766-000	S1-HSI-405*
9050	S1-HSI-402	108803-G1	S1-HSI-406	025-27774-000	S1-HSI-405*
INTERCITY		RAYPAK		025-29043-000	S1-HSI-405*
1009604	S1-HSI-412*	600915	S1-HSI-403	025-29050-000	S1-HSI-405*
MAJESTIC		RHEEM			
75-92-104	S1-HSI-402	62-22441-01	S1-HSI-408		
75-92-105	S1-HSI-402	62-22441-01	S1-HSI-402		
METZGER		62-22868-82	S1-HSI-411*		
201N	S1-HSI-402	SP-10972	N/A		
201W	S1-HSI-402				

Gas Heating Controls

POWER GENERATORS, THERMOCOUPLES, HOT SURFACE IGNITERS, FLAME SENSORS

SOURCE 1® Timesaver™ Silicon Nitride Igniters



Compare To White-Rodgers 21D64-2 And Honeywell Q3200u1004. Replaces Over 100 Silicon Carbide Igniters.

Features:

- Robust Igniter Design - For Longer Life And Fewer Callbacks
- Universal Bracket Fits Most Furnaces
- Reduces Inventory, Easy To Install
- 3-Year Warranty

Specifications:

- Electrical Rating: Input 102-132 Vac, 60Hz, Max. Load Current 3.0 A @ 132 Vac, 25 Degrees C
- Timing Rating 17 Seconds Minimum

Kit Includes:

- Silicon Nitride Igniter With 15.5" Leads
- One "Universal" Mounting Bracket And Screw
- Mounting Adaptor Bracket
- 2 Ceramic Wire Nuts
- Updated Manufacturer Cross-Reference
- Instruction Booklet

SOURCE 1 PART NO.	DESCRIPTION	MLP \$
S1-HSI-SN1	UNIVERSAL NITRIDE HOT SURFACE UPGRADE KIT	55.00

MANUFACTURER	OEM PART NO	MANUFACTURER	OEM PART NO	MANUFACTURER	OEM PART NO
AMANA	10735003A, 20165703S, 20165703, 201657-03, Model 601	INTERCITY	1009604, 1096048	VISSMAN	9302-094
AMERICAN ROAD EQUIPMENT	201W	MAJESTIC	75-92-104, 75-92-105	WAYNE HOME EQUIPMENT	62821-001, 62821-002
ARCO AIR	1096048, 1380680	METZGER	201N, 201W	WEIL MCLAIN	511-330-139, 511-330-188, 511-330-190, 511-330-193
ARMSTRONG AIR	38322B001	MODINE	5H76032A	WHITE LB	120-07549
CARLIN	87197S	MOR-FLO	3200618, 511-330-193	WHITE RODGERS	767A-301, 767A-303, 767A-306, 767A-310, 767A-311, 767A-350, 767A-353, 767A-354, 767A-357, 767A-361, 767A-364, 737A-365, 767A-366, 767A-370, 767A-371, 767A-372, 767A-373, 767A-375, 767A-376, 767A-377, 767A-378, 767A-382, 767A-383, 767A-384
CARRIER/BRYANT/PAYNE*	LH33ZS001, LH33ZS001A, LH33ZS002, LH33ZS002A, LH33ZS003, LH33ZS003A, LH33ZS004	NORDYNE	105141000, 632-0770, 632-0880	WILLIAMSON	9050
CLAIRE BROS.	C-238, C242	NORTON/ST GOBAIN	201, 201D, 201J, 201K, 201L, 201M, 201N, 201R, 201W, 271, 271M, 271N, 271NM, 271P, 271W	YORK/LUXAIRE	025-27766-000, 025-27774-000, 025-29043-000, 025-29050-000, 2532625000
COLEMAN	1474-051, 1474-052	RAYPAK	600915		
COMFORT MAKER	1096048	RHEEM/RUUD	62-22441-01, 62-22868-02		
DETROIT RADIANT	201D	ROBERTS GORDON	62-22868-82, 62-22868-93, 90434300, 90436600		
DMO IND	20834	ROBERTSHAW	41-402, 41-403, 41-404, 41-405, 41-407, 41-408, 41-409, 41-410, 41-411, 41-412, 41-413, 41-414, 41-418		
DORNBACK FURNACE	271W	SNYDER GENERAL	1380654, 1380672, 1380680		
DUCANE	20015201	SUPERIOR FIREPLACE	94851		
ENERCO TECH	10399	TEMPSTAR	1096048		
EVCON	1474-051, 1474-052	TRANE	340039P01, B138196P01, B144676P01, B144676P02, B340039P01, IGN00023, IGN00026, IGN00030, IGN00034		
EVCON COLEMAN	025-32625-000				
GOODMAN	0230K00001, B1401009, B140109S, B1401015S, B1401018, B1401018S				
HB SMITH	50018				
HEIL	1096048				
HONEYWELL	GLOWFLY (Q3200U)				
HUPP INDUSTRIES	9050				

*For Carrier sealed combustion furnaces, you must use Assembly 6 and reuse the existing orange gasket.

Universal Brackets Included to Replace these Ceramic Block-Style Silicon Carbide Igniters

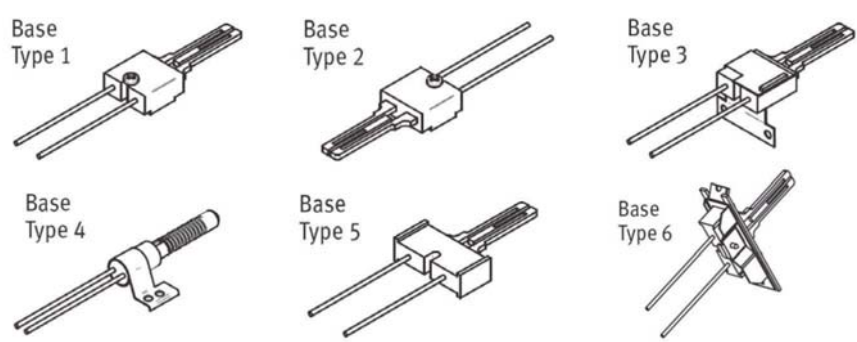

AIR CONDITIONING & HEATING CONTROLS

Gas Heating Controls

POWER GENERATORS, THERMOCOUPLES, HOT SURFACE IGNITERS, FLAME SENSORS

Source 1 Silicon Nitride Igniters



Source 1's Nitride Hot Surface Igniters provide reliable ignition in a variety of heating systems.

- Replaces Carrier, Lennox, Rheem, Trane, and others
- Can reach ignition temperature(s) in 16 seconds
- 18-gauge nickel chrome lead wires enclosed with high-temperature fiberglass insulation

SOURCE 1 PART NO.	DESCRIPTION	MLP
S1-SCP-700413	IGNITER,HOT SURFACE,ROUND NITRIDE	66.52
S1-SCP-700513	IGNITER,HOT SURFACE,MINI FLAT NITRIDE	62.11

Source 1 Flame Sensors



Notes:

- Sensor rod to be press fitted or cemented and must withstand 7 inch-pounds of torque without coming loose.
- Insulation resistance from rod to bracket must be 500 megaohms minimum
- Electrode material: Kanthal D, Hoskins 815 or engineering approved equivalent
- Ceramic material: Alumina 95% or better.
- Bracket material: Zinc plated (class2, type2 .0003 min. thickness with clear chromate coating) steel or stainless steel
- Bracket must be tight (withstand 5 in-lb of torque without rotating)
- Terminal material: Nickel plated steel

SOURCE 1 PART NO.	DESCRIPTION	MLP
S1-SCP-9007053	FLAME SENSOR, MODEL 900-3	28.85
S1-SCP-9007054	FLAME SENSOR, MODEL 900-4	28.85
S1-SCP-9007055	FLAME SENSOR, MODEL 900-5	28.85
S1-SCP-9007056	FLAME SENSOR, MODEL 900-6	28.85

IGNITION MODULES & INTEGRATED FURNACE CONTROLS

Honeywell S8610U Universal Intermittent Pilot Module



Electronic control of most intermittent pilot ignition systems used on gas-fired furnaces, boilers and other heating appliances. Provides ignition sequence, flame monitoring and safety shutoff (max. 90 sec.) for intermittent pilot central furnaces and heating appliances. Features 100 percent pilot gas shutoff if pilot fails to light; after 6-minute delay, trial for ignition is repeated. Ignition trial/delay sequence is repeated until the appliance lights or call for heat is removed. For use with natural or LP gas. For use in single rod or dual rod/remote sense applications. Includes relay contacts for use with any intermittent pilot gas control string with maximum 1.0A pilot or 2.0A main valve rating; Honeywell VR8204, VR8304 or VR8345M combination gas control recommended. Functional equivalent of S86, S90, S8600 and S8610 modules. Includes cable adapters to allow field replacement of both Honeywell and competitive controls without replacing existing cable. Improved enclosure design protects internal circuitry from moisture or dust accumulation. Includes remote reset, and automatic vent damper plug. Replaces most of the following intermittent pilot modules:

- Honeywell S86, S90, S8600 and S8610
- Robertshaw SP715, SP715A, SP735, SP735A, SP735L
- Johnson GSA, G60, G65, G67, G600, G770 Refer to S8610 specification sheet for a complete list of model numbers.
- **Approval Bodies:**
 - American Gas Association Design certified.
 - Canadian Gas Association Design certified.
 - UL Inc. Component recognized.
- **Wiring connections:** 1/4" male quick connect terminals, including ignition terminal (3/16" male
- **Electrical ratings:** voltage and frequency – 24v (nominal), 60hz. Current rating – 0.2A
- **Note:** maximum ambient temperature is 175°F [79°C] if main valve relay load is 1.0A or less.
- **Ambient temperature rating:** –40°F to +165°F [–40°C to +74°C].
- **Flame failure response time:** 0.8 Sec. At 1.0 Ma flame current. quick-connect sense terminal).
- **Thermostat heat anticipator setting:** 02a plus pilot valve rating plus main valve rating. Spark generator output - 13 kv peak at 25 pf load.

SOURCE 1 PART NO.	PILOT		MAIN		MLP
	RUNNING	INRUSH	RUNNING	INRUSH	
S1-S8610U3009	1.0A	10.0A	2.0A	20.0A	363.81

Gas Heating Controls

IGNITION MODULES & INTEGRATED FURNACE CONTROLS

White Rodgers Mercury Flame Sensors



The mercury flame sensor is a mechanical device that proves the existence of an acceptable pilot flame. It converts the heat of a pilot flame to motion which is used to open and close a set of electrical contacts, and consists of a bulb, capillary, diaphragm, snap-switch mechanism, and mercury-fill. When the bulb is heated by a pilot flame, the mercury is vaporized causing pressure in the capillary and diaphragm. Movement of the diaphragm causes the snap-switch to open one set of contacts, and close a second set. These contacts control the pilot valve and the main valve.

Features:

- Bulb styles are designed to fit with various OEM applications.
- Adapter fittings to allow use of these mercury flame sensors with competitive burners are packed with controls identified with an asterisk(*).
- A.G.A. Design certified and C.G.A. Certified.
- Maximum temp. 1450°F at bulb tip.

SOURCE 1 PART NO.	DESCRIPTION	INPUT VOLTAGE	ELECTRICAL RATING	BULB STYLE	MLP
S1-3049-115	REPLACES BULB STYLES #17 OR #18	48"	D	#20	588.36
S1-3098-134	REPLACES BULB STYLES #9 OR #13	48"	E	#19	588.40
S1-3098-156	REPLACES BULB STYLES #17 OR #18	48"	E	#20	588.40

*Adapter fittings packed with control

S9200U1000 Hot Surface Ignition Integrated Furnace Control



Universal integrated furnace control replaces multiple single stage field installed hot surface ignition IFC supplied by White Rodgers and UTEC. Uses 120 VAC igniter. Includes instructions special wire harnesses for easy replacement.

Features:

- Main burner ignition using a 120V hot surface igniter.
- Flame rectification circuit to monitor flame presence.
- Monitoring of system pressure switch, high temperature limit, and rollout functions.
- Appliance operation/safety requirements controlled via microprocessor.
- Control of a standard induction-type circulating fan motor (based on appliance requirements), in response to a conventional low voltage or EnviraCOM™ thermostat.
- LED system status, performance and diagnostic indication.
- Wire harnesses provided for simple replacement of most IFCs and integration with most heating and cooling appliances.
- Twinning capability
- EnviraCOM™ communication capability to enable local and/or remote system status, diagnostics, troubleshooting, and HVAC system control.

SOURCE 1 PART NO.	DESCRIPTION	MLP
S1-S9200U1000	INTEGRATED FURNACE CONTROL	340.72

S8910U3000 Universal Hot Surface Ignition Module



Universal hot surface ignition module replaces multiple field installed hot surface ignition modules supplied by Honeywell, White-Rodgers, Robertshaw and Johnson. Uses a 120 VAC igniter. Includes instructions and accessories for easy replacement.

Features:

- Replaces many White-Rodgers, Robertshaw and Honeywell hot surface ignition models.
- For 120 Vac (up to 5.0A) surface igniter (Norton 201/271 or equivalent).
- For local (single rod) or remote (dual rod) rectification type flame sensing.
- Contains easy-to-use instructions plus the accessories required to adapt the existing hot surface ignition module.
- Provides one or three ignition trials (four-second or seven-second trials) per call for heat; prepurge of 32 seconds or less; up to 96 seconds between purge trial times.
- Temperature range is -40 to +175 F (-40 to +79 C).

SOURCE 1 PART NO.	DESCRIPTION	MLP
S1-S8910U3000	UNIVERSAL HOT SURFACE IGNITION MODULE	408.27

Gas Heating Controls

IGNITION MODULES & INTEGRATED FURNACE CONTROLS

Universal Silicon Carbide Integrated Ignition Module



The 50A55-843 employs a microprocessor to continually monitor, analyze and control the proper operation of the gas burner, inducer and fan.

Electrical Ratings at 77°F (25°C):

Input Voltage: 25 VAC 50/60 Hz

Maximum Input Current: at 25 VAC 0.45 amp

Operating Temperature: -40° to 176°F (-40° to 80°C)

Humidity: 5% to 93% relative humidity (non condensing)

SOURCE 1 PART NO.	DESCRIPTION	REPLACES	MLP
S1-50A55-843	UNIVERSAL SILICON CARBIDE INTEGRATED IGNITION MODULE	50A55-143, 50A55-285, 50A55-286, 50A55-438	326.51

50A65-843 Carbide Non-Integrated Hot Surface Ignition Module

Gas-Fired Non-Integrated Forced-Air Furnaces and Boilers

Features:

- Program Keys for Easy Customization
- Tri-Color LED Indicator for Diagnostics
- Direct and Indirect Flame Sense

Specifications:

Electrical Rating

- Input 18 to 30 VAC, 25 VAC nominal
- Max. Input Current @ 25 VAC; 200mA @ 25°C

Relay Load Settings

- Valve Relay: 1.5 amps @ 25 VAC 60 Hz .6pf
- Ignitor Relay: 6.0 amps @ 120 VAC 60 Hz resistive

Kit Includes:

- Program Keys
- Mounting Hardware
- Double-Sided Foam Back Tape (for ease of installation)
- Extensive Cross-Reference Guide
- Color-Coded Timing Label
- Pre-Printed Hanging Carton
- Instructions in English/Instrucciones en Español

SOURCE 1 PART NO.	DESCRIPTION	DIMENSIONS	MLP
S1-50A65-843	CARBIDE NON-INTEGRATED IGNITION MODULE	4.13 X 4.13 X 1.5	348.47

For Silicon Carbide, Non-Integrated HSI Systems



Replaces ALL White-Rodgers 50E47-xxx modules and virtually all competitive silicon carbide, non-integrated modules.

Features:

- Program Keys for Easy Customization
- Tri-Color LED Indicator for Diagnostics
- Direct and Indirect Flame Sense

Electrical Rating

- Input 18 to 30 VAC, 25 VAC nominal
- Max. Input Current @ 25 VAC; 200mA @ 25°C

Relay Load Settings

- Valve Relay: 1.5 amps @ 25 VAC 60 Hz .6pf
- Igniter Relay: 6.0 amps @ 120 VAC 60 Hz resistive

SOURCE 1 PART NO.	DESCRIPTION	DIMENSIONS	MLP
S1-50E47-843	FOR SILICON CARBIDE, NON-INTEGRATED HSI SYSTEMS	4.13" W X 4.13" H X 1.5" D	336.04

Gas Heating Controls

IGNITION MODULES & INTEGRATED FURNACE CONTROLS

Single Stage Carbide and Nitride HSI Systems



Replaces: Virtually All White-Rodgers and Competitive Single Stage Carbide and Nitride HSI Systems – Including Carrier Systems.*

Includes:

- Ignition Control Module – 50M56-843
- 12 Quick-Select/Quick-Connect Wiring Harnesses
- Universal Nitride Ignitor Kit – 21D64-2
- Installation Instructions and OEM Cross-Reference

Features:

- 3 Fan Speeds – Cool, Low Heat & High Heat Speeds
- Color-Coded (Labeled) Thermostat Connection
- System Diagnostics, with Fault Recall (Stored)
- Cover Label – Displays Diagnostic Table
- Red LED Light – Used for Diagnostic Flash Codes
- Low Voltage – Fuse Protection – 3A automotive type
- Humidifier & Electronic Air Cleaner Connections
- Color LED Indicator for Diagnostics
- Direct and Indirect Flame Sense

Specifications

- Electrical Rating [@ 77°F (25°C)]
- Input Voltage: 25 VAC 50/60 Hz
- Max. Input Current @ 25 VAC: 0.45 amp

Relay Load Ratings

- Valve Relay: 1.5 amp @ 25 VAC 50/60 Hz 0.6 pf
- Igniter Relay: 6.0 amp @ 120 VAC 50/60 Hz (resistive)
- Circulator Relay: 14.5 FLA—25.0 LRA @ 120 VAC

Flame Current Requirements

- Minimum current to insure flame detection: 1 µA DC*
- Maximum current for non-detection: 0.1 µA DC*
- *Measured w/ DC microammeter in flame probe lead

Operating Temperature Range

- -40° to 176°F (-40° to 80°C)

Mounting

- Surface mount multi-poise
- Surface mount multi-poise

Timing Specifications (@ 60 Hz)

- Max. Flame Establishing Time: 0.8 sec
- Max. Flame Failure Response Time: 2.0 sec

Gases Approved: Natural, Manufactured, Mixed

- Liquefied Petroleum, and LP Gas-Air Mixtures are all approved for use.

Relay Load Rating

- Main Valve Relay: 1.5A @ 25 VAC 60 Hz

Hot Surface Ignition

- 120 VAC

Dimensions

- 5.25" W x 7" H x 1.25" D

SOURCE 1 PART NO.	DESCRIPTION	DIMENSIONS	MLP
S1-50M56U-843	SINGLE STAGE CARBIDE AND NITRIDE HSI SYSTEMS	5.25" W X 7" H X 1.25" D	381.02

Direct Spark Non-Integrated Spark Ignition Module



Features

- Color Led Indicator For Diagnostics
- Direct And Indirect Flame Sense

Electrical Rating

- Input 18 To 30 VAC, 25 VAC Nominal

- Max. Input Current: @25 VAC: 0.2A + Mv @ 25°C

Relay Load Ratings

- Main Valve Relay: 25 VAC, 1.5 Amp Max.
- Pilot Valve Relay: 25 VAC, 1.5 Amp Max

SOURCE 1 PART NO.	DESCRIPTION	MLP \$
S1-50D50-842	DIRECT SPARK NON-INTEGRATED SPARK IGNITION MODULE, 4.13" W X 4.13" H X 1.5" D	329.87

Intermittent Pilot Non-Integrated Spark Ignition Module



Features:

- Color Led Indicator For Diagnostics
- Direct And Indirect Flame Sense

Electrical Rating

- Input 18 To 30 Vac, 25 VAC Nominal
- Max. Input Current @ 25 VAC; 0.2A + Mv +Pv @ 25°C

Relay Load Settings

- Main Valve Relay: 25 VAC, 1.5 Amp Max
- Pilot Valve Relay: 25 VAC, 1.5 Amp Max

SOURCE 1 PART NO.	DESCRIPTION	MLP \$
S1-50D50-843	INTERMITTENT PILOT NON-INTEGRATED SPARK IGNITION MODULE, 4.13" W X 4.13" H X 1.5" D	326.60

Gas Heating Controls

IGNITION MODULES & INTEGRATED FURNACE CONTROLS

Y8610U4001 Intermittent Pilot Retrofit Kit

Intermittent Pilot Retrofit Kit are complete kits converting conventional standing pilot system to intermittent pilot system. For use with 24 VAC gas-fired atmospheric furnaces, boiler and heating appliances.

Features:

- Y8610U kits are for use with natural or LP gas: provides 100 percent pilot gas shutoff if pilot fails to light; after 6-minute delay, trial for ignition is repeated.
- Ignition trail/delay sequence is repeated until the appliance lights or call for heat is removed



SOURCE 1 PART NO.	DESCRIPTION	MLP
S1-Y8610U4001	INTERMITTENT PILOT RETROFIT KIT	735.12

ICM Furnace Control Modules

Furnace Fan Blower Control



Features:

- Microprocessor-Based
- Twinning Compatible With Another ICM Board-Identical Model

SOURCE 1 PART NO.	DESCRIPTION	OUTPUTS	TIME DELAYS	MLP \$
S1-ICM280	INDUCER FAN OUTPUTS, HOT SURFACE IGNITOR OUTPUT FLAME SENSOR INPUT GAS VALVE OUTPUT 18-30 VAC	FAN: 2 HP @ 240 VAC INDUCER FAN: 7A @ 250 VAC GAS VALVE: 1A @ 24 VAC IGNITOR: 5A @120 VAC	HEAR ON: 30 SEC, HEAT OFF: 90, 120, 150 SEC, COOL OFF: 60 SEC	230.08

REPLACES:

SOURCE 1 PART NO.	GOODMAN	UTEC	TEXAS INSTRUMENTS	WHITE RODGERS	CARRIER
S1-ICM280	B1809906/08/10/13/135	1012-933D	41F-5	50T35-730, 50T35-743	---

Gas Valve, Ignitor, Blower Motor, Inducer, Humidifier & Air Cleaner Controls



S1-ICM281

S1-ICM282

SOURCE 1 PART NO.	DESCRIPTION	OUTPUTS	TIME DELAYS	MLP \$
S1-ICM281	MODEL SELCETION OF 80+ AND 90+ FURNACE OPERATION	LINE RANGE: 98-132 @ 60 Hz IGNITER 5A @ 120 VAC COOL BLOWER: 10A, 2HP, 240 VAC HEAT: 5A 1/2HP, 240 VAC INDUCER MOTOR: 4A, FLA-8.0 LRA @ 120 VAC GAS VALVE: 1.5A @ 30 VAC	HEAT BLOWER ON: 40 SEC HEAT BLOWER OFF: 90, 135, 180, 225 SEC FAN (LOW) ON/OFF: 1 SEC COOL ON: 5 SEC COOL OFF: 90 SEC	263.97

REPLACES:

SOURCE 1 PART NO.	GOODMAN	UTEC	TEXAS INSTRUMENTS	WHITE RODGERS	CARRIER
S1-ICM281	---	---	---	---	CESO110057-00/01/02

Gas Heating Controls

IGNITION MODULES & INTEGRATED FURNACE CONTROLS

ICM278



ICM278 Fan Blower Control – Low cost replacement for Carrier HH84AA017 and HH84AA018

Specifications:

Input Voltage: Terminals:

- 120/240 VAC: N1-N5, S1-S5, H, L, L1, D1
- 18-30 VAC: Y, G, W, C, R, W2, X, HL, PS1, PS2

Line Frequency: 60 Hz

Operating Temperature: 40°F to +176°F

Maximum Operating Humidity: 95% R.H.Non-condensing @ 50°C

Time Delays: - Heat ON: 60 Seconds

- Heat OFF: 60-200 Seconds
- Cool OFF: 40 Seconds

SOURCE 1 PART NO.	DESCRIPTION	MLP \$
S1-ICM278	LOW COST, FAN BLOWER CONTROL BOARD, CARRIER HH84AA017/18	267.38

ICM284



Features:

- Controls Vent Motor, Blower Control, Hot Surface Ignitor And Gas Valve
- Microprocessor Based, Designed For 100% Gas Shutoff In Case Of Ignition Failure
- Monitors Timing, Trial For Ignition, Flame Sensing And Lockout
- Diagnostic Leads Aid In Testing/Troubleshooting

Specifications:

Electrical

- Line Voltage Range: 208 VAC @ 60Hz
- Ignitor: 5A Resistive @ 208 VAC
- Cool Blower: 30 A, 2 Hp, 240 VAC
- Heat Blower: 10 A, 1/2 Hp, 250 VAC
- Inducer Motor: 4A, 208 VAC
- Gas Valve: 4A @ 24 VAC
- Compressor: 5A Resistive @ 24 VAC

Environmental

- Ambient Temperature
Operating: -40°C To 80°C
Storage: -40°C To 85°C
- Humidity: 5% - 95% R.h. (Non-Condensing) At +55°C

Replaces:

- York: S1-03101280000

SOURCE 1 PART NO.	DESCRIPTION	MLP \$
S1-ICM284	LOW COST, DIRECT REPLACEMENT FURNACE CONTROL BOARD	814.26
S1-ICM286	FURNACE CONTROL MODULE, GOODMAN	123.38

ICM287



Features:

Controls Inducer And Blower Control
Designed For 100% Gas Shutoff In Case Of
Monitors Timing And Gas Valve

Specifications:

Electrical

- Line Voltage Range: 120 VAC @ 60Hz
- Control Voltage: 24 VAC @ 60 Hz
- Cool Blower: 30 A Resistive @ 120 VAC
- Heat Blower: 10 A Resistive @ 120 VAC
- Inducer Motor: 10A, 208 VAC
- Gas Valve: 4A Resistive @ 120 VAC

Microprocessor Based

Ignition Failure

Diagnostic Leds Aid In Testing/Troubleshooting

Environmental

- Ambient Temperature
Operating: -40°C To 80°C
Storage: -40°C To 85°C
- Humidity: 5% - 95% R.h. (Non-Condensing) At +55°C

Replaces:

- Goodman: B18099-04

SOURCE 1 PART NO.	DESCRIPTION	MLP \$
S1-ICM287	LOW COST, DIRECT REPLACEMENT FURNACE CONTROL BOARD	272.09

ICM288

Replacement for Rheem 62-24084-82 control boards



Specifications:

- **Voltage Range:** Line 98-132 VAC @ 60Hz
- **Igniter:** 5A, 120 VAC
- **Cool Blower:** 10A, 2HP, 240 VAC
- **Heat:** 5A, 1/2 HP, 250 VAC
- **Inducer Blower:** 4A, 120 VAC
- **Gas Valve:** 1A, 24 VAC
- **Humidifier Motor:** 0.5A, 24 VAC
- **Electronic Air Cleaner:** 1A, 120 VAC

SOURCE 1 PART NO.	DESCRIPTION	MLP \$
S1-ICM288	FURNACE CONTROL BOARD	304.68

Gas Heating Controls

IGNITION MODULES & INTEGRATED FURNACE CONTROLS

ICM289



Features:

- Low Cost, Direct Replacement Board For Lennox
- Microprocessor Based Design
- Controls Inducer Fan Motor, Blower Fan And Monitors Limit Switches
- Functions With All 24 VAC Thermostats

Specifications:

Electrical

- Voltage Range: Line (98 To 132 Vac) @ 60Hz
- Cool Blower: 20A, 120 VAC
- Heat Blower: 20A, 120 VAC
- Inducer Motor: 5A, 120 VAC
- Cool Blower On Display: 1 Second
- Cool Blower Off Display: 1 Second
- Heat Blower On Display: 45 Seconds
- Heat Blower Off Delay: 90, 150, 210, 270 Seconds

Replaces:

- Lennox: All Bcc1, Bcc2 And Bcc3 Circuit Boards, Including Models Lb-53622A, Bcc2-2Rev8, 35K77, 35K7701, Lb-90089A, 65K29, 65K2901, Lb-50709Bd, Lb-65126A, Lb-89859, Lb-87086A, Lb-87086, Lb-63622Aa, Lb-90676A, 40L8801, 30H6701, 48K98, 48K9801, 45K48, 45K4801, 78J6101, 68H08.

SOURCE 1 PART NO.	DESCRIPTION	MLP \$
S1-ICM289	LOW COST, DIRECT REPLACEMENT FURNACE CONTROL BOARD	313.69

ICM290A



Replacement for popular models, including Honeywell S8610U-3009

Specifications:

- Control Voltage:** Line 24V (18-30 VAC), 50/60Hz
- Anticipator Setting:** 0.3A plus valve load @ 24 VAC
- Trial for Ignition:** 15 or 90 sec (switch selectable)
- LED:** Green status LED Provides system status and error codes
Yellow Flame LED indicates flame presence and flame strength

SOURCE 1 PART NO.	DESCRIPTION	MLP \$
S1-ICM290A	CONTINUOUS RETRY IGNITION CONTROL	280.25

ICM Furnace Control Boards

ICM2801



Replacement for York/Evcon 7990-319P control boards

Specifications:

- Line Voltage Range:** 98 to 132 VAC @ 60Hz
- Igniter:** 5A @ 120 VAC
- Cool Blower:** 10, 2HP, 240 VAC
- Heat:** 5A, 1/2 HP, 250 VAC
- Inducer Motor:** 4A FLA, 8A LRA @ 120 VAC
- Gas Valve:** 1A @ 24 VAC

SOURCE 1 PART NO.	DESCRIPTION	MLP \$
S1-ICM2801	FURNACE CONTROL BOARD	316.67

Gas Heating Controls

IGNITION MODULES & INTEGRATED FURNACE CONTROLS

ICM2804



NOTE: This board functions identically as the CES0110074-00 and the CES0110074-01. It is the direct replacement of the CES0110074-01. When replacing the CES0110074-00 some quick connectors have to be changed or added. EAC-1 and EAC-2 must have 1/4" connectors. COM, SEC-1 and SEC-2 must have 3/16" connectors.

SOURCE 1 PART NO.	DESCRIPTION	MLP \$
S1-ICM2804	LOW COST, DIRECT REPLACEMENT FURNACE CONTROL BOARD	267.82

ICM2805



Features:

- Controls Gas Valve, Inducer Draft Motor, Circulating Blower And Hot Surface Ignitor
- Monitors Timing, Trial For Ignition, Flame Sensing, Lockout, Plus Pressure, Rollout And Limit Switches.
- Microprocessor-Based Precision, Twinning Compatible With Another ICM2805A Furnace Control
- Diagnostic Leds Aid In Testing And Troubleshooting
- Replaces: Nordyne 903106-Kit (For Use With G3, G4, G5, G6, M2 And M3 Furnace Models)

Specifications:

- Voltage Range: Line (98 To 132 Vac) @ 60 Hz
- Ignitor: 5A, 120 VAC
- Cool Blower: 10A, 2Hp, 240 VAC
- Heat: 5A, 1/2 HP, 250 VAC
- Inducer Blower: 4A, 120 VAC
- Gas Valve: 1A, 24 VAC
- Humidifier Motor: 0.5A, 24 VAC
- Electronic Air Cleaner: 1A, 120 VAC

SOURCE 1 PART NO.	DESCRIPTION	MLP \$
S1-ICM2805	LOW COST, FORM, FIT, AND FUNCTIONAL REPLACEMENT	282.34

ICM2807



Specifications:

- Ambient Temperature
 - Operating: -40°F to 176°F
 - Humidity: 5% to 95% R.H. (non-condensing @ +55°F)
- Voltage Range: Line (98 to 132 VAC) @ 60Hz
- Ignitor: 5A @ 120 VAC
- Cool Blower: 10 HP, 120 VAC
- Low Heat: 5A 1/2 HP, 120 VAC
- High Heat: 10A 1 HP, 120 VAC
- Inducer Motor: 4A FLA-8.0, LRA @ 120 VAC
- Gas Valve: 1.5A @ 30 VAC
- EAC: 1A @ 120 VAC
- Humidifier: 0.5A & 24 VAC

SOURCE 1 PART NO.	DESCRIPTION	MLP \$
S1-ICM2807	LOW COST REPLACEMENT FOR CARRIER HK42FZ017	313.69

ICM2808



The ICM2808 is a low cost fit, form and functional replacement for the York S1-33103010000 and S1-22102956000 furnace control boards.

Specifications:

- Voltage Range:** Line (98 to 132 VAC) @ 60 Hz
- Control Voltage Range:** 18-30 VAC @ 60 Hz
- Relay Outputs:** Meets or exceeds OEM board
- Heat Blower On Delay:** 30 Seconds
- Heat Blower Off Delay:** 90-180 Seconds
- Ambient Temperature:** Operating: -40°F to 176°F
- Storage:** -40°F to 185°F
- Humidity:** 5% to 95% R.H. (non-condensing) @ +55°F

SOURCE 1 PART NO.	DESCRIPTION	MLP \$
S1-ICM2808	BOARD, CTRL, FURNACE, YORK REPL	180.84

Gas Heating Controls

IGNITION MODULES & INTEGRATED FURNACE CONTROLS

ICM291



Features:

- Low cost, direct replacement board for Carrier: LH33WP003a
- Direct Spark Ignition (DSI) Control Board
- Microprocessor Based
- Controls Combustion, Blower and Indoor Fan Motors; Spark Igniter; and The Gas Valve
- Monitors Timing, Trial for Ignition, Flame Sensing and Lockout
- 100% Lockout Safety Feature
- Compatible With LP Or Natural Gas
- Status Led For Fault Codes To Aid In Troubleshooting

Input:

- Power: Rt And C
- Thermostat Interface: R, W, And G
- Safety Switches: Rs, Ls, And Cs
- Combustion Motor Hall Effect Sensor
- Flame Sensing

Led Indicators:

- Steady On- Normal Operation; Flashing - Fault Codes

Specifications:

- Control Voltage: 24 VAC (18-30 Vac), 60 Hz
- Line Voltage: 208/230 VAC, 60 Hz

Timing:

- Pre-Purge: 45 Seconds
- Trial For Ignition: 5+2 Seconds
- Ignition: Every 20 Seconds For 15 Minutes
- Retry Period: Manual Reset
- Lockout: 45 Seconds

Outputs:

- Spark
- Gas Valve: GV
- Combustion Motor: CM
- Blower Motor: BM
- Indoor Fan Motor: IFO

SOURCE 1 PART NO.	DESCRIPTION	MLP \$
S1-ICM291	LOW COST, DIRECT REPLACEMENT FURNACE CONTROL BOARD	415.25

ICM Spark Ignition Controls

ICM292



Features:

- Low Cost, Direct Replacement Board For Rheem: 62-24140-04
- Direct Spark Ignition (Dsi) Control Board
- Microprocessor Based
- Controls Inducer Motors, Air Cleaner (If Equipped), Humidifier (If Equipped), Spark Igniter, And Gas Valve
- Monitors Timing, Trial For Ignition, System Switches, Flame Sensing And Lockout
- 100% Lockout Safety Feature
- Compatible With Lp Or Natural Gas
- Status Led For Fault Codes To Aid In Troubleshooting

Led Indicators:

- Power, Green Led: Pwr

Input:

- Power: 24 Vac And Com
- Thermostat Interface: R, W, Y And G
- Safety Switches: Vent Pressure And Limit Switches (Main And Over-Temperature Switches In Series)
- Flame Sensing
- Heat Blower Off Delay (Miniature Slide Switch Set)

- Status, Green Led: Ok
- Flame Status, Yellow Led: Flame

Specifications:

- Control Voltage: 24 Vac (18-30 Vac), 60 Hz
- Line Voltage: 115 Vac, 60 Hz

Timing:

- Pre-Purge: 30 Seconds
- Trial For Ignition: 7 Seconds
- Retries: 2 Groups Of 2; 30 Sec Delay Within Group And 3 Min Delay Between Groups.
- Lockout: 45 Seconds
- Post-Purge: 90, 120, 160, And 180 Seconds

Outputs:

- Spark
- Gas Valve: GV
- Inducer Draft Motor: Idm
- Blower Motor: Fan, Cool, And Heat Speeds
- Electric Air Cleaner: Eac
- Humidifier Relay: Hum, Heat/Cool Relay: H/C

SOURCE 1 PART NO.	DESCRIPTION	MLP \$
S1-ICM292	LOW COST, DIRECT REPLACEMENT FOR RHEEM: 62-24140-04	313.69

ICM294



Replacement for popular models, including York 025-27762-700 and JCI G770RJA-1 series controls.

Specifications:

- **Control Voltage:** Line 24V (18-30 VAC), 50/60 Hz
- **Anticipator Setting:** 0.3A plus valve load @ 24 VAC
- **Prepurge:** None
- **Trial for Ignition:** 85 seconds
- **Flame Failure Response Time:** 0.5 seconds
- **Retry:** None

SOURCE 1 PART NO.	DESCRIPTION	MLP \$
S1-ICM294	INTERMITTENT PILOT IGNITION CONTROL	305.57

Gas Heating Controls

IGNITION MODULES & INTEGRATED FURNACE CONTROLS

ICM295



Features:

- For Use With Intermittent Pilot Boilers, Furnaces Or Other Heating Appliances
- Microprocessor-Based Precision,
- Compatible With LP Or Natural Gas
- Continuous Spark Until Pilot Flame Established
- Replaces Carrier LH33WZ510 And Comparable Ignition Controls

Specifications:

- Control Voltage: Line 24 Vac (18-30 Vac) @ 50/60 Hz
- Prepurge: 0 To 10 Seconds (System Dependent)
- Retries: Continuous
- Operating Temperature: -40°F (-40°C) To 75°C (176°F)
- Relative Humidity: 0% To 95% Non-Condensing
- Spark Frequency: 15Hz For 90 Seconds, 10Hz Thereafter

SOURCE 1 PART NO.	DESCRIPTION	MLP \$
S1-ICM295	LOW COST, FORM FIT FUNCTION REPLACEMENT	136.68

Intermittent Pilot Ignition Control

ICM296



Features:

- For Use With Intermittent Pilot Boilers, Furnaces Or Other Heating Appliances
- Microprocessor-Based Precision,
- Compatible With LP Or Natural Gas
- 100% Safety Lockout
- Replaces Carrier LH33WZ512 And Comparable Ignition Controls Requiring 100% Safety Lockout

Specifications:

- Control Voltage: Line 24 Vac (18-30 Vac) @ 50/60 Hz
- Prepurge: None
- Lockout: 5-6 Minutes
- Retries: None
- Operating Temperature: -40°F (-40°C) To 75°C (176°F)
- Relative Humidity: 0% To 95% Non-Condensing
- Relay Contact Rating: 1 Amp @ 24 Vac
- Trial For Ignition: 90 Seconds
- Flame Failure Response Time: 0.8 Second Max
- Spark Frequency: 60Hz

SOURCE 1 PART NO.	DESCRIPTION	MLP \$
S1-ICM296	LOW COST, FORM FIT FUNCTION REPLACEMENT	228.37

ICM1501



Intermittent ignition oil primary control with 15-second safety timing; replacement for Honeywell R8184G Series.

Specifications:

- **Ignition Type:** Intermittent Timing
- **Safety Switch:** 15
- **Mounting Bracket:** Standard 4x5 J-Box or direct mounting on burner housing
- **Electrical Rating (Contacts - Full Load):** 7.4 A @ 120 VAC, 3.7 A @ 240 VAC
- **Electrical Rating (Contacts - Locked Rotor):** 44.4 A @ 120 VAC, 22.2 A @ 240 VAC
- **Temperature Range:** -30°F to 130°F
- **Approvals:** UL Approved.

SOURCE 1 PART NO.	DESCRIPTION	MLP \$
S1-ICM1501	INTERMITTENT IGNITION OIL PRIMARY CONTROL	292.23

Gas Heating Controls

IGNITION MODULES & INTEGRATED FURNACE CONTROLS

ICM1502



Intermittent ignition oil primary control with 30-second safety timing; replacement for Honeywell R8184G Series.

Specifications:

- **Ignition Type:** Intermittent Timing
- **Safety Switch:** 30
- **Mounting Bracket:** Standard 4x5 J-Box or direct mounting on burner housing
- **Electrical Rating (Contacts- Full Load):** 7.4 A @ 120 VAC, 3.7 A @ 240 VAC
- **Electrical Rating (Contacts - Locked Rotor):** 44.4 A @ 120 VAC, 22.2 A @ 240 VAC
- **Temperature Range:** -30°F to 130°F
- **Approvals:** UL Approved.

SOURCE 1 PART NO.	DESCRIPTION	MLP \$
S1-ICM1502	INTERMITTENT IGNITION OIL PRIMARY CONTROL	311.98

ICM1503



Intermittent ignition oil primary control with 45-second safety timing; replacement for Honeywell R8184G Series.

Specifications:

- **Ignition Type:** Intermittent Timing,
- **Safety Switch:** 45
- **Mounting Bracket:** Standard 4x5 J-Box or direct mounting on burner housing
- **Electrical Rating (Contacts- Full Load):** 7.4 A @ 120 VAC, 3.7 A @ 240 VAC
- **Electrical Rating (Contacts - Locked Rotor):** 44.4 A @ 120 VAC, 22.2 A @ 240 VAC
- **Temperature Range:** -30°F to 130°F
- **Approvals:** UL Approved.

SOURCE 1 PART NO.	DESCRIPTION	MLP \$
S1-ICM1503	INTERMITTENT PILOT GAS IGNITION CONTROL	292.23

Intermittent Pilot Ignition Control

ICM2901



Replacement for popular models, including York 025-27762-700 and JCI G770RJA-1 series controls.

Specifications:

- **Control Voltage:** Line 24V (18-30 VAC), 50/60 Hz
- **Anticipator Setting:** 0.3A plus valve load @ 24 VAC
- **Prepurge:** None
- **Trial for Ignition:** 85 seconds
- **Flame Failure Response Time:** 0.5 seconds
- **Retry:** None

SOURCE 1 PART NO.	DESCRIPTION	MLP \$
S1-ICM2901	INTERMITTENT PILOT IGNITION CONTROL	292.23

ICM2902



Replacement for popular models, including Lennox 30W33 and JCI G776RGD-14 series controls

Specifications:

- **Control Voltage:** Line 24V (18-30 VAC), 50/60 Hz
- **Anticipator Setting:** 0.3A plus valve load @ 24 VAC
- **Prepurge:** 15 seconds
- **Trial for Ignition:** 85 seconds
- **Lockout:** 60 minutes
- **Flame Failure Response Time:** 2 seconds
- **LED:** See product for error codes

SOURCE 1 PART NO.	DESCRIPTION	MLP \$
S1-ICM2902	INTERMITTENT PILOT IGNITION CONTROL	311.98

Gas Heating Controls

IGNITION MODULES & INTEGRATED FURNACE CONTROLS

Multi-Stage Carbide and Nitride HSI Systems

21M51U-843 for 3-Speed PSC Motors



Replaces: White-Rodgers 50M51-242 and all 50M61-XXX's Two Stage HSI Systems With 80V Or 120V Igniter.

Includes:

- Ignition Control Module
- Universal 120 V Nitride Ignitor Kit - 21D64-2
- Installation Instructions And OEM Cross-Reference

Features:

- 120 VAC Igniter Output; Two-Speed Inducer Output
- 120 VAC Humidifier Output; Electronic Air Cleaner Output
- 120 Vac 3-Speed PSC Circulator Output
- 2-Stage Gas Valve Output
- Fuse Protection-3 Amp
- Furnace Status LED - Tri-Color (G, R, Amber)
- Heat Fan OFF Delay (Dipswitch Selectable)
- Fan ON Delay for Cooling
- Auto Second Stage Delay (Dipswitch Selectable Mode)
- Historical Fault Retrieval by pushbutton
- YLO, Y, W1, W2, R, G, C, TWIN Terminals
- Pressure Switch Inputs and Monitoring
- Flash Microprocessor with Non-volatile Memory
- Flame Current Measurement Points

Gases Approved: Natural, Manufactured, Mixed, LP and LP/Air Mixtures

Specifications:

- Electrical Ratings [@77°F (25°C)]
- Input Voltage: 24 VAC, 60 Hz (Class II transformer req'd)
- Nom. Input Current @ 24 VAC: 530mA +MV

Relay Load Ratings:

- Gas Valve Relays: 1.5 amps @ 24 vac, 60 Hz
- Inducer Relays: 2.2 FLA - 3.5 LRA @ 120 VAC
- Circulator Relays: 14.5 FLA - 250.0 LRA @ 120 VAC
- Humidifier Load: 1.0 amp max @ 120 VAC
- Electronic Air Cleaner Load: 1.0 amp max @ 120 VAC
- Ignitor Relay: 4.0 amps max @ 132 VAC, 60 Hz

Flame Current Requirements

- Min current to insure flame detection: 0.3 µA DC*
- Max current for non-detection: 0.1 µA DC*
- Max allowable leakage resistance: 100 M ohms
- *Measured w/ DC Microammeter in the flame probe lead
- **Operating Temperature:** -40° to 175°F (-40° to 80°C)
- **Humidity:** 5% to 93% relative humidity (non-condensing)
- **Timing Specs:** (@ 60 Hz): Flame Failure Response Time: 2.0 Sec Max

SOURCE 1 PART NO.	DESCRIPTION	MLP \$
S1-21M51U-843	MULTI STAGE CARBIDE AND NITRIDE HSI SYSTEMS, 5.25" W X 8" H X 1.25" D	571.51

21V51U-843 for Variable Speed Motors



Replaces: White-Rodgers 50V51-XXX and all 50V61-XXXX's Two Stage Hsi Systems With 80V Or 120V Igniter.

Includes:

- Ignition Control Module
- Wiring Harnesses for Amana/Goodman
- Universal 120 V Nitride Ignitor Kit - 21D64-2
- Installation Instructions And Oem Cross-Reference

Features:

- 120 VAC Igniter Output; Two-Speed Inducer Output
- 120 VAC Humidifier Output; Electronic Air Cleaner Output
- 120 Vac 3-Speed PSC Circulator Output
- 2-Stage Gas Valve Output
- 16-Pin Variable Speed Circulator Output
- OEM Application - Dipswitch Selectable
- Fuse Protection-3 Amp
- Furnace Status LED - Tri-Color (G, R, Amber)
- CFM LED - (Green)
- Heat Fan OFF Delay (Dipswitch Selectable)
- Fan ON Delay for Cooling
- Auto Second Stage Delay (Dipswitch Selectable Mode)
- Historical Fault Retrieval by Push button
- YLO, Y, W1, W2, R, G, C, BK/DS/Dehum Terminals
- Pressure Switch Inputs and Monitoring
- Flash Microprocessor with Non-Volatile Memory
- Flame Current Measurement Points

Specifications:

- Electrical Ratings [@77°F (25°C)]
- Input Voltage: 24 VAC, 60 Hz (Class II transformer req'd)
- Nom. Input Current @ 24 VAC: 595 mA +MV

Relay Load Ratings

- Gas Valve Relays: 1.5 amps @ 24 vac, 60 Hz
- Inducer Relays: 2.2 FLA - 3.5 LRA @ 120 VAC
- Humidifier Load: 1.0 amp max @ 120 VAC
- Electronic Air Cleaner Load: 1.0 amp max @ 120 VAC
- Ignitor Relay: 4.0 amps max @ 132 VAC, 60 Hz

Flame Current Requirements

- Min current to insure flame detection: 0.3 µA DC*
- Max current for non-detection: 0.1 µA DC*
- Max allowable leakage resistance: 100 M ohms
- *Measured w/ DC Microammeter in the flame probe lead

Operating Temperature: -40° to 175°F (-40° to 80°C)
Humidity: 5% to 93% relative humidity (non-condensing)

Timing Specs: (@ 60 Hz): Flame Failure Response Time: 2.0 Sec Max

Gases Approved: Natural, Manufactured, Mixed, LP and LP/Air Mixtures

SOURCE 1 PART NO.	DESCRIPTION	MLP \$
S1-21V51U-843	MULTI STAGE CARBIDE AND NITRIDE HSI SYSTEMS, 5.25" W X 8" H X 1.25" D	571.51

Gas Heating Controls

IGNITION MODULES & INTEGRATED FURNACE CONTROLS

Hot Surface Ignition Controls

York Single Stage HSI Integrated Furnace Control Kit

White
Rodgers



Replaces White-Rodgers 50A56-242 and 50A56-243 and Virtually All York Single Stage HSI Controls with 120V Igniters. Easy install kit includes: ignition control module, installation instructions and OEM cross-reference, replacement control box

- Selectable Continuous Fan Speed
- System Diagnostics LED with Fault Recall
- Third Fan Speed
- Two-Stage Cooling Y2 Input
- 120 VAC Ignitor Output
- 120 VAC Humidifier Output
- 120 VAC Electronic Air Cleaner Output
- 120 VAC 2-Speed PSC Circulator Output
- Fuse Protection — 5 Amp
- Heat Fan OFF Delay (Dipswitch Selectable)
- Ignition Trial Time: 7 Seconds
- Prepurge Period: 0 Seconds
- Retries: 2 Times

SOURCE 1 PART NO.	DESCRIPTION	MLP \$
S1-50A56-956	MODULE,CONTROL,FURNACE,YORK120V	221.33

Trane Single Stage 80V Ignitor HSI Integrated Furnace Control Kit

White
Rodgers



Replaces White-Rodgers and Trane Single Stage HSI Controls with 80V Igniters
Easy install kit includes: ignition control module, installation instructions and OEM cross-reference

- 80 VAC Ignitor Output
- 120 VAC Humidifier Output
- 120 VAC Electronic Air Cleaner Output
- 120 VAC 2-Speed PSC Circulator Output
- Fuse Protection — 5 Amp
- Furnace Status LED
- Heat Fan OFF Delay (Dipswitch Selectable)
- Ignition Trial Time: 5 Seconds
- Prepurge Period: 0 Seconds
- Retries: 2 Times

SOURCE 1 PART NO.	DESCRIPTION	MLP \$
S1-50A65-5165	MODULE,CONTROL,FURNACE,TRANE80V	270.69

Trane Single Stage 120V Ignitor HSI Integrated Furnace Control Kit

White
Rodgers



Replaces White-Rodgers and Trane Single Stage HSI Controls with 120V Igniters
Easy install kit includes: ignition control module, installation instructions and OEM cross-reference

- 120 VAC Ignitor Output
- 120 VAC Humidifier Output
- 120 VAC Electronic Air Cleaner Output
- 120 VAC 2-Speed PSC Circulator Output
- Fuse Protection — 5 Amp
- Furnace Status LED
- Heat Fan OFF Delay (Dipswitch Selectable)
- Ignition Trial Time: 4 Seconds
- Prepurge Period: 0 Seconds
- Retries: 2 Times

SOURCE 1 PART NO.	DESCRIPTION	MLP \$
S1-50A55-3797	MODULE,CONTROL,FURNACE,TRANE120V	265.61

Carrier Single Stage HSI Integrated Furnace Control Kit

White
Rodgers



Replaces White-Rodgers 50M56-751 and virtually all Carrier single stage HSI controls with 120V igniters
Easy install kit includes: ignition control module, installation instructions and OEM cross-reference, set of interconnect harnesses, bag of accessories

- System Diagnostic LED with Fault Recall
- Low-Speed Continuous Fan Option
- 120 VAC Ignitor Output
- 120 or 24 VAC Humidifier Output
- 120 VAC Electronic Air Cleaner Output
- Self-Test Installation Routine
- Ignition Trial Time: 4 Seconds
- Prepurge Period: 30 Seconds
- Retries: 2 Times

SOURCE 1 PART NO.	DESCRIPTION	MLP \$
S1-50M56U-751	MODULE,CONTROL,FURNACE,CARRIER120V	389.58

Gas Heating Controls

FAN & LIMIT CONTROLS

White Rodgers Fan & Limit Controls for Universal Replacement



Single element type for applications with narrow space limitations. Regulates fan or blower operation and acts as high limit safety control.

Features:

- Designed to be interchangeable with other flush mounted, single element fan and limits.
- Slotted mounting holes for easy installation.
- Long Terminal screws for wiring—Junctions can be made on terminal block.
- Limit switch has “universal” contact structure capable of handling millivolts to 240 VAC.
- Limit switch has adjustable stop to limit maximum setting—Shipped at 200° F (94° C).
- Dial has individual pointers for fan cut-in and cut-out settings.
- Removable solid copper jumper between fan and limit switches.
- Summer fan switch for ventilation without changing control settings. Has same fan and limit switch mechanism.
- C.S.A. Certified and U.L. Recognized.

Specifications and Cross Reference:

VENDOR TYPE NO	DESCRIPTION	RANGE	DIFFERENTIAL	SWITCH ACTION	FULL ELECTRICAL RATING	MOTOR RATING (FULL LOAD)		VALVES AND RELAYS	
						120 VAC	240 VAC	24 VAC	0.3-12V DC
5D51 SERIES	FAN	50 TO 265° F (10 TO 129° C)	ADJUSTABLE 15°F MINIMUM	CLOSE ON RISE	HT	14.0A	7.0A	--	--
	LIMIT	100 TO 300° F (38 TO 149° C)	FIXED 25° F	OPEN ON RISE	HTV	10.0A	6.0A	6.0A	1.0A
SOURCE 1 PART NO.		DESCRIPTION			ELEMENT LENGTH		MLP		
S1-5D51-35		WITH STANDARD ENCLOSURE			5"		284.74		
S1-5D51-78		WITH STANDARD ENCLOSURE			11"		290.33		
S1-5D51-90		WITH STANDARD ENCLOSURE			8"		290.25		

White Rodgers Fan & Limit Controls for Universal Replacement

For control of high limit and fan motor in all types of forced air heating systems.



Features:

- Three wiring terminal options available for easy installation: push-in receptacles for stripped wire, female receptacles for 1/4" male flag connectors, and field add-on screw terminals.
- Controls adapt to many competitive mounting holes in replacement applications.
- Available in a variety of fan and high limit setting ranges.
- Super Tradeline models include deluxe case with mounting adapters for easy installation and strain relief bushings to protect wiring from field abuse.

Specifications:

Application: Turns fan on and off according to plenum temperature. With helical bimetal sensing element. High limit stop factory set at 200°F (93°C). Replaces L4064A,B,E.

Fan-on Range: 65°F to 215°F (18°C to 102°C)

Fan-off Range: 50°F to 200°F (10°C to 96°C)

Pilot duty: 0.25 A @ 0.25 to 12 Vdc, 2 A @ 24 VAC

Dimensions: 5-3/8"H x 3"W x 2"D (137 mm H x 76 mm W x 51 mm D) excluding element.

Mounting: Rigid bracket

Differential Temperature: 25°F (14°C), fixed.

Approvals: UL Listed; CSA Certified.

SOURCE 1 PART NO.	HIGH LIMIT TEMPERATURE RANGE	ELEMENT INSERTION LENGTH	MAX. AMBIENT TEMPERATURE RATINGS		ELECTRICAL RATING FAN		ELECTRICAL RATING LIMIT		MLP
			SWITCH	SENSING ELEMENT	(AFL)	(ALR)	(AFL)	(ALR)	
S1-L4064B2236	100°F TO 250°F (38°C TO 121°C)	8" (203 MM)	190°F (88°C)	350°F (177°C)	7 A @ 240 VAC, 14 A @ 120 VAC	42 A @ 240 VAC, 84 A @ 120 VAC	4 A @ 240VAC, 8 A @ 120 VAC	24 A @ 240 VAC, 48 A @ 120 VAC	277.90

*L4064B Models have manual fan switch that overrides fan control to keep fan running continuously.

L4064B Fan/Limit Controllers

For control of high limit and fan motor in all types of forced air heating systems.



Features:

- Three wiring terminal options available for easy installation: push-in receptacles for stripped wire, female receptacles for 1/4 in. male flag connectors, and field add-on screw terminals.
- Controls adapt to many competitive mounting holes in replacement applications.
- Available in a variety of fan and high limit setting ranges.
- Manual fan switch overrides fan control to keep fan running continuously.
- Mounting adapters for easy installation and strain relief bushings to protect wiring from field abuse.

SOURCE 1 PART NO.	DESCRIPTION	MLP \$
S1-L4064B2210	FAN/LIMIT CONTROLLER W/ 11.5" INSERTION	283.23
S1-L4064B2228	FAN/LIMIT CONTROLLER W/ 5" INSERTION	272.61

AIR CONDITIONING & HEATING CONTROLS

Electric Heating Controls

HEAT SEQUENCERS

Model 24A34 Electric Heat Sequencers



Direct replacement for most fan/heat sequencing functions. Terminal markings are equivalent to competitive types and allow one wiring method for various sources of sequencers.

Features:

- Replaces Honeywell, Klixon (Texas Instruments), MARS, TOD, GEMLINE types.
- Solid-state reliability.
- Ambient rated from -50 to +165°F.
- 24V input control.
- Multi-poise mounting.
- Any contacts (except M1 and M2) can be used as auxiliary contacts.
- Double quick-connect terminals for combination loads.
- U.L. Component recognized.

24A34-15

Normally Open Contacts 1-3

Used in heat pump air handler applications.

Specifications:

Electrical Ratings

Single Load Contact Ratings (All Models):

Provides a delay off to the blower motor in cooling mode. Single pole double throw.

VAC	RESISTIVE (NON-INDUCTIVE)		MOTOR RATINGS (INDUCTIVE)		PILOT DUTY
	WATTS	AMPS	FULL LOAD	LOCKED ROTOR	
120	3000	25.0	10.0A (14.0A FOR 24A34-15)	60.0A (72 FOR 24A34-15)	125 VA
240	6000	25.0	5.0A (7 FOR 24A34-15)	30.0A (42 FOR 24A34-15)	125 VA
480	6000	12.5	3.0A	18.0A	480 VA

Combined Load Rating (All Models):

30A @ 240 VAC — TOTAL; 23A Non-inductive + 7 FLA/42 LRA Inductive.

ON TIME — Elapsed time to make contacts after heater is energized (Min. to Max.).

OFF TIME — Elapsed time to break contacts after heater is de-energized (Min. to Max.).

SOURCE 1 PART NO.	NUMBER OF TIMINGS	NUMBER OF SWITCHES	MLP
S1-24A34-1	1	1	14.13
S1-24A34-14	4	5	43.95
S1-24A34-15	1	1	37.73
S1-24A34-2	1	1	14.13
S1-24A34-3	1	2	16.67
S1-24A34-4	1	2	16.67
S1-24A34-5	2	3	25.46
S1-24A34-6	2	4	28.18

TIMINGS										
SOURCE 1 PART NO.	ON					OFF				
	M1-M2	M3-M4	M5-M6	M7-M8	M9-M10	M1-M2	M3-M4	M5-M6	M7-M8	M9-M10
S1-24A34-1	1-20	--	--	--	--	40-110	--	--	--	--
S1-24A34-2	--	--	30-90	--	--	--	--	1-30	--	--
S1-24A34-3	1-20**		--	--	--	40-110**		--	--	--
S1-24A34-4	--	--	30-90**		--	--	--	1-30**		--
S1-24A34-5	1-110**		1-110	--	--	1-110**		1-110	--	--
S1-24A34-6	1-110**				--	1-110**				--
S1-24A34-14	1-160**		1-160			1-160**		1-160		
S1-24A34-15	1-60 (ON 1-3)					75-95 (OFF 1-3)				

*M1-M2 and M3-M4 are always first switches to turn ON and last to turn OFF. All other switches are random ON and random OFF.

†24A34-14 Switch contacts designated F1-F2 instead of M1-M2.

**These contacts switch simultaneously.

Note: Underwriters Laboratories requires a fan interlock circuit to insure the blower remains operating whenever more than one sequencer is used.

The fan interlock should be the M1-M2 contacts of the second or third sequencer. All M1-M2 contacts are wired to the blower motor so that any sequencer that is energized will keep the blower ON.

Electric Heating Controls

SNAP DISC LIMIT SWITCHES

White Rodgers Adjustable Snap Disc Fan & Limit Controls



This adjustable Snap Disc Thermostat allows you to set the temperature set point to match your specific needs which simplifies inventory.

Features:

- 1/4" quick connect terminals are standard.
- Reduces inventory while providing coverage for a wide range of temperature applications.
- Replaces the majority of fixed disc thermostats now on heating equipment and various appliances.
- 2 adjustable fan control models replace 7 fixed snap disc models.
- 4 adjustable limit control models replace 10 fixed snap disc models.

Accessories: Adapter plates (order separately.): F6-1798 1 per pack.

Typical Electrical Ratings

VAC	RESISTIVE (NON-INDUCTIVE)	MOTOR RATINGS (INDUCTIVE)		PILOT DUTY
		FULL LOAD	LOCKED ROTOR	
120	25.0A	14.0A	72.0A	125 VA
240	25.0A	10.0A	60.0A	125 VA

SOURCE 1 PART NO.	TEMPERATURE RANGE	DIFFERENTIAL	SWITCH ACTION	FUNCTION	ACCESSORIES	"THERM-O-DISC" NUMBER	MLP
S1-3F05-1	90 TO 130° F	20°F	SPST	FAN CONTROLS (CLOSE ON RISE)	INCLUDES THERMOSTAT AND TAB-TO-SCREW TERMINALS	74T12-310708	39.51
S1-3F05-2	140 TO 180 ° F	20°F	SPST	FAN CONTROLS (CLOSE ON RISE)	INCLUDES THERMOSTAT AND TAB-TO-SCREW TERMINALS	74T12-310709	39.92
S1-3L05-1	135 TO 175 ° F	40°F	SPST	LIMIT CONTROLS (OPEN ON RISE)	INCLUDES THERMOSTAT AND TAB-TO-SCREW TERMINALS	74T11-310710	39.92
S1-3L05-10	135 TO 175° F	20°F	SPST	LIMIT CONTROLS (OPEN ON RISE)	INCLUDES THERMOSTAT AND TAB-TO-SCREW TERMINALS	74T11-310724	39.92
S1-3L05-13	250 TO 290 ° F	40°F	SPST	LIMIT CONTROLS (OPEN ON RISE)	INCLUDES THERMOSTAT AND TAB-TO-SCREW TERMINALS	74T11-310730	39.92
S1-3L05-2	175 TO 215 ° F	40°F	SPST	LIMIT CONTROLS (OPEN ON RISE)	INCLUDES THERMOSTAT AND TAB-TO-SCREW TERMINALS	74T11-310711	39.92
S1-3L05-3	210 TO 250° F	40°F	SPST	LIMIT CONTROLS (OPEN ON RISE)	INCLUDES THERMOSTAT AND TAB-TO-SCREW TERMINALS	74T11-310712	39.92

Fan Controls

SOURCE 1 PART NO.	FIXED TEMPERATURE SETTINGS		SWITCH ACTION	"THERM-O-DISC" PART NO.	MLP
	CUT-IN	CUT-OUT			
S1-3F01-110	110° F (43° C)	90° F (32° C)	CLOSE ON RISE	60T12-610044	15.94
S1-3F01-120	120° F (49° C)	110° F (43° C)	CLOSE ON RISE	60T12-610046	15.83
S1-3F01-130	130° F (54° C)	115° F (46° C)	CLOSE ON RISE	60T12-610047	15.76
S1-3F01-140	140° F (60° C)	120° F (49° C)	CLOSE ON RISE	60T12-610049	15.76
S1-3F01-150	150° F (66° C)	130° F (54° C)	CLOSE ON RISE	60T12-610050	15.83
S1-3F01-160	160° F (71° C)	140° F (60° C)	CLOSE ON RISE	60T12-610064	15.76
S1-3F01-180	180° F (82° C)	160° F (71° C)	CLOSE ON RISE	60T12-610065	15.64
S1-3F01-200	200° F (93° C)	180° F (82° C)	CLOSE ON RISE	60T12-610066	15.83

SPDT



SOURCE 1 PART NO.	FIXED TEMPERATURE SETTINGS TERMINAL 1 & 3		FIXED TEMPERATURE SETTINGS TERMINAL 1 & 2		SWITCH ACTION	"THERM-O-DISC" PART NO.	MLP \$
	CUT-OUT	CUT-IN	CUT-IN	CUT-OUT			
S1-3L03-140	140° F (60° C)	120° F (49° C)	140° F (60° C)	120° F (49° C)	SPDT	60T13-611015	24.35
S1-3L03-190	190° F (88° C)	170° F (77° C)	190° F (88° C)	170° F (77° C)	SPDT	60T13-611014	24.73

ELECTRICAL RATING (AC) FOR TYPE NUMBERS	MOTOR RATING (FULL LOAD)		RESISTIVE (NON-INDUCTIVE)		PILOT DUTY 120/240/277 VAC
	120 VAC	240 VAC	120/240 VAC	277 VAC	
3L01	10.0 A	5.0 A	25.0 A	21.6 A	125 VA
3L02	10.0 A	5.0 A	25.0 A	21.6 A	125 VA
3L03	1 & 2 CLOSE ON RISE	5.8 A	2.9 A	--	125 VA
	1 & 3 OPEN ON RISE	10.0 A	5.0 A	25.0 A	125 VA

AIR CONDITIONING & HEATING CONTROLS

Electric Heating Controls

SNAP DISC LIMIT SWITCHES

White Rodgers Snap Disc Fan Controls

SPST

AIR CONDITIONING & HEATING CONTROLS

SOURCE 1 PART NO.	FIXED TEMPERATURE SETTINGS		SWITCH ACTION	"THERM-O-DISC" PART NO.	MLP
	CUT-IN	CUT-OUT			
S1-3L01-130	115° F (46° C)	130° F (54° C)	OPEN ON RISE	60T11-61002	15.76
S1-3L01-140	100° F (38° C)	140° F (60° C)	OPEN ON RISE	60T11-610006	15.94
S1-3L01-150	110° F (43° C)	150° F (66° C)	OPEN ON RISE	60T11-610009	15.94
S1-3L01-165	125° F (52° C)	165° F (74° C)	OPEN ON RISE	60T11-610069	15.83
S1-3L01-170	130° F (54° C)	170° F (77° C)	OPEN ON RISE	60T11-610012	15.94
S1-3L01-180	140° F (60° C)	180° F (82° C)	OPEN ON RISE	60T11-610013	15.83
S1-3L01-190	150° F (66° C)	190° F (88° C)	OPEN ON RISE	60T11-610015	15.94
S1-3L01-200	160° F (71° C)	200° F (93° C)	OPEN ON RISE	60T11-610016	15.94
S1-3L01-230	190° F (88° C)	230° F (110° C)	OPEN ON RISE	60T11-610021	15.64
S1-3L01-250	210° F (99° C)	250° F (121° C)	OPEN ON RISE	60T11-610023	15.94
S1-3L01-300	250° F (121° C)	300° F (149° C)	OPEN ON RISE	60T11-610026	15.76

SPECIFICATIONS ELECTRICAL RATINGS

MODEL	MOTOR RATINGS (FULL LOAD)		RESISTIVE (NON-INDUCTIVE)		PILOT DUTY
	120 VAC	240 VAC	120/240 VAC	277VAC	120/240/277 VAC
3F01, 3F02	10.0 A	5.0A	25.0A	21.6A	125 VA

Limit Controls - Manual Reset



SOURCE 1 PART NO.	FIXED TEMPERATURE SETTINGS		SWITCH ACTION	"THERM-O-DISC" PART NO.	MLP \$
	CUT-IN	CUT-OUT			
S1-3L02-160	MANUAL RESET	160° F (71° C)	OPEN ON RISE	60T15-330534	26.07
S1-3L02-180	MANUAL RESET	180° F (82° C)	OPEN ON RISE	60T15-330536	26.07
S1-3L02-190	MANUAL RESET	190° F (88° C)	OPEN ON RISE	60T15-330537	26.07
S1-3L02-200	MANUAL RESET	200° F (93° C)	OPEN ON RISE	60T15-330538	26.45

Oil Heating Controls

OIL BURNER PROTECTORELAYS

Honeywell R8184G Protectorelay Oil Burner Control



Provides automatic, nonrecycling control of an intermittent ignition oil burner system.

Approval Bodies: Component recognized by Underwriters Laboratories Inc. Certified by Canadian Standards Association.

Approximate Dimensions: 4 in. [108 mm] wide, 4 in. [111 mm] high, 2 in. [64 mm] deep.

Ambient Temperature Range: -40 F to 130 F [-40 C to 54 C].

Thermostat Anticipator Setting: 0.2 A.

Electrical Ratings: Voltage and Frequency – 120 V, 60 Hz.

- Controls oil burner, oil valve (if desired) and the ignition transformer in response to a call for heat.
- Solid state flame sensing circuit.
- LED on terminal strip indicates system lockout. Remote lockout indication available on some models.
- External button to manually reset safety switch after lockout.
- Manual trip lever opens safety switch for system maintenance. Mounts on standard 4 x 4 in. junction box or directly on burner housing.
- C554A Cadmium Sulfide Flame Detector and 24 VAC thermostat required.

Load Relay Contacts (A)

MOTOR RATING	120 VAC	240 VAC
FULL LOAD	7.4	3.7
LOCKED ROTOR	44.4	22.2

Ignition Rating - 360 VA (in addition to above motor rating)

SOURCE 1 PART NO.	SAFETY SWITCH TIMING	MLP \$
S1-R8184G4009	45 SECONDS	270.44

Thermostats

AQUASTAT CONTROLLERS

L4006A1678 Aquastat Controller



High or Low Limit

Overview

Aquastat® Controllers are immersion type devices for limiting or regulating the temperature of liquids in boilers, storage tanks, and other applications where temperature control is required.

Features:

- Totally enclosed Micro Switch™ snap-acting switches operate on temperature rise to setpoint.
- Visible control point scale and external adjustment screw permit easy setting.
- Horizontal or vertical insertion of the sensing element.
- Direct or well immersion of the sensing element.
- Models available for strap-on mounting.
- Remote bulb model may be used to sense air temperature in ducts and in outside air sensing applications.

SOURCE 1 PART NO.	DESCRIPTION	MLP \$
S1-L4006A1678	HIGH OR LOW LIMIT AQUASTAT CONTROLLER	303.09

HONEYWELL AQUASTAT® RELAYS



Immersion-type controllers that combine high limit protection with switching relay control of burner and circulator motors.

Features:

- High limit opens burner circuit only.
- Include transformer and accessory terminals for adding a remote low limit controller.
- Case available for horizontal or vertical mounting.
- Requires a 24 VAC thermostat with heat anticipator set at 0.2A.
- TRADELINE models include well adapter, tube of heat conductive compound and range stops.

Specifications:

Application: High Limit

Operating Range, High Limit (F): 120°F to 240°F

Operating Range, High Limit (C): 54°C to 116°C

Differential Temperature (F): 8°F fixed

Setpoint Temperature Range (F): 240°F

Setpoint Temperature Range (C): 116°C

Switching Action SPST: High Limit & Circulator

Anticipator Setting: 0.2 A

Maximum Operating Pressure (psi): Immersion Well: 255 psi

Maximum Operating Pressure (kPa): Immersion Well: 1757 kPa

Electrical Ratings (burner AFL): Line Voltage: 7.4 A @ 120 VAC; 3.7 A @ 240 VAC

Electrical Ratings (burner ALR): Line Voltage: 44.4 A @ 120 VAC; 22.7 A @ 240 VAC

Electrical Ratings (burner millivolt): 0.25 A @ 1/4 to 12 Vdc

Electrical Ratings (circulator AFL): 7.4 A @ 120 VAC; 3.7 A @ 240 VAC

Electrical Ratings (circulator ALR): 44.4 A @ 120 VAC; 22.2 A @ 240 VAC

Voltage: 120 VAC

Frequency: 60 Hz

Capillary Length (in.): 4-1/2"

Capillary Length (mm): 114 mm

Insulation Depth (in.): 1-1/2" to 3" less well.

Insulation Depth (mm): 38 mm to 76 mm less well

Humidity Ratings (%RH): 0 to 95% RH, noncondensing

Maximum Ambient Temperature (F): 150°F with 1.2 A 24 V load; 77 F with 1.4 A 24 V load

Maximum Ambient Temperature (C): 66°C with 1.2 A 24 V load; 25 C with 1.4 A 24 V load

Electrical Connections: Quick-Connect / Screw

Approvals, Underwriters Laboratories Inc

UL Listed: File No. MP466, Vol. 13, Sec. 2, Guide No. MBPR2.

Approvals, Canadian Standards

Association Certified: File No. LR1620, Guide No. 400-E-O

SOURCE 1 PART NO.	APPLICATION	MOUNTING TYPE	DIMENSIONS		MLP \$
			HORIZ. MOUNT	VERT. MOUNT	
S1-L8148A1017	HIGH LIMIT	HORIZONTAL	4-5/16"H X 6-1/8"W X 3-1/8"D (110 MM H X 156 MM W X 79 MM D)	-	510.28
S1-L8148J1009	AQUASTAT RELAY	VERTICAL/HORIZONTAL	4-5/16"H X 6-1/8"W X 3-1/8"D (110 MM H X 156 MM W X 79 MM D)	6-1/8"H X 4-5/16"W X 3-1/8"D (156 MM H X 110 MM W X 79 MM D)	599.65

Hydronic Heating Controls & Gas Water Heater Valves

HONEYWELL ZONE VALVES



Sweat less end switch zone valve, necessary for temperature control of a single zone in a hydronic heating system.

Features:

- Use with thermostat with special heat anticipator designed for best performance when used with the V8043 Zone Valve.
- Require 24 V power source.

Specifications:

Body Pattern: 2-Way

Pipe Connections: Sweat

Valve Electrical Rating (Voltage, Frequency): 24 VAC, 50/60 Hz

Valve Electrical Connections (in.): 18" leads

Valve Action: Spring return to close

Valve Dimensions (in.): Valve: 4"H, 3-1/2"W, 2-3/8"D

Valve Dimensions (mm): Valve: 101 mm H x 90 mm W x 60 mm D

Approvals, Underwriters Laboratories Inc

UL Listed: Models V8043A,B,E,J & V8044A,B,E; UL Component Recognized: V8043F

Approvals, Canadian Standards Association

CSA Certified: File no. LR95329-1

SOURCE 1 PART NO.	PIPE SIZE	MAXIMUM CLOSE-OFF PRESSURE		CAPACITY		MLP \$
		PSI	KPA	CV	KV	
S1-V8043A1029	3/4"	20	138	3.5	3	215.62

WHITE RODGERS GAS WATER HEATER VALVES



For replacement of standard gas water heater controls with built-in E.C.O. (Energy Cut Off).

Features:

- Automatic shut-off of main and pilot gas in the event of pilot failure.
- Pilot gas cock with safe lighting feature.
- Pilot gas filter.
- Temperature adjustment.
- Manifold pressure tap.
- Built-in E.C.O. (Energy Cut Off) non-cycling high limit.
- A.G.A. Certified.

Specification:

Inlet Size: — 1/2" NPT.

Outlet Size: — 1/2" Inverted Flare

Outlet Adapter Fittings (furnished with controls

noted below): 1/2" inverted flare x 3/8" NPT reducer adapter. 1/2" x 1/2" inverted flare outlet extension adapter (F26-0021)

Mounting: 3/4" NPT, 1-1/4", shank length, 4-1/2" bulb insertion length

Pilot Connection: 1/4" compression fitting for use with Natural Gas

SOURCE 1 PART NO.	DESCRIPTION	PRESSURE REGULATION		TEMPERATURE RANGE	SHANK LENGTH	MLP \$
		MAIN BURNER	PILOT			
S1-37C73U-168	GAS WATER HEATER VALVES 1-1/4" SHANK LENGTH	3.5" W.C.	FIXED	70 TO 160°F (21 TO 71°C)	1-1/4"	283.09

*Outlet adapter fittings included

HVAC Components

CONTACTORS

Source 1 Definite Purpose Contactors

SOURCE 1 PART NO.	POLES	AMPS	VOLTAGE	MLP \$
S1-DP130024	1	30	24	14.75
S1-DP230024	2	30	24	19.20
S1-DP230120	2	30	120	19.20
S1-DP230240	2	30	240	19.20
S1-DP240024	2	40	24	21.93
S1-DP240120	2	40	120	21.93
S1-DP240240	2	40	240	21.93
S1-DP330024	3	30	24	35.77
S1-DP330120	3	30	120	35.77
S1-DP330240	3	30	240	35.77
S1-DP340024	3	40	24	37.19
S1-DP340120	3	40	120	52.56
S1-DP340240	3	40	240	37.19

Type 3100 and 3186 Contactors

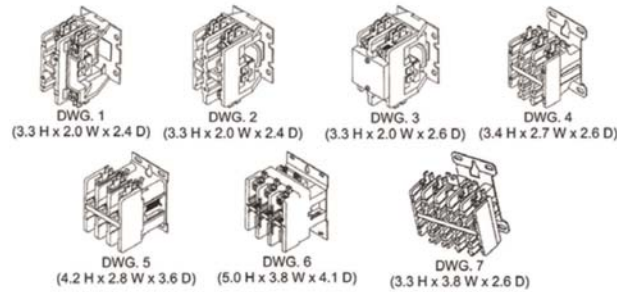

Features:

- Application - power and pilot duty
- Insulation class B
- All terminals are combination screw & push-on
- 50/60 Hz
- Meets device specifications up to 600 VAC per bulletin 508
- Panel mounted
- Dimensions are maximum
- Box lug power terminal (L)

SOURCE 1 PART NO.	VENDOR PART NO.	POLE CONFIG. (NORM. OPEN)	CONTACT RATINGS FLA			CONTACT RATINGS LRA			CONTACT RATINGS R RTG.		COIL DATA					WIRE SIZE		DWG. NO.	MLP \$
			240 V	480 V	600 V	240 V	480 V	600 V	240 V	480/600 V	VTS.	HZ	INS. CLASS	MAX INRUSH VA 50/60	MAX SEALED VA 50/60	MAX	MIN		
S1-02425839700	3100Y20T615	2P	30	30	30	150	125	100	40	40	120	50/60	B	40/37	10/8	8	16	2	24.42
S1-02425842701	3100Y30Q915HT	3P*	30	30	30	180	150	120	40	40	24	50/60	B	55/52	11/9	8	16	4	89.88
S1-02425843700	3100Y30T915	3P	30	30	30	180	150	120	40	40	120	50/60	B	55/52	11/9	8	16	4	47.39
S1-02425845700	3100Y30T1015CL	3P	40	40	40	240	200	160	50	50	120	50/60	B	55/52	11/9	4	14	4	48.16

* Indicates Auxillary Contacts (1) Normally Open (NO), (1) Normally Closed (NC), Rated 10A @ 115-600 Volts

HVAC Components

CONDENSATION CONTROLS & COMPRESSOR PROTECTION MODULES

ICM Condensation Controls



ICM's condensate control systems protect cooling and refrigeration equipment by detecting and preventing overflows in the evaporator condensation pan due to slow and/or blocked drains or pump failure.

Specifications:

Input: 18–30 VAC, 50–60 Hz

SOURCE 1 PART NO.	ADDITIONAL FEATURES	OUTPUT	DELAY	DIMS (IN)	MLP \$
S1-ACH55	OPTIONAL OVERFLOW ALARM LED KIT FOR USE WITH S1-ICM340 OR S1-ICM342 CABLE LENGTH: 6 FT.	--	--	--	29.54
S1-ICM340	2 SENSORS MAX. OPERATING/STORAGE RH 95% NON-CONDENSING STORAGE TEMPERATURE: -40°F TO 85°C REPLACES WATER GUARD: 401475	24 VAC TO THERMOSTAT/ COOLING CONTROL 24 VAC TO OPTIONAL OVERFLOW LED 2AMPS	1–3 MIN.	—	67.25
S1-ICM342	ALARM OUTPUT DURING LOCKOUT CONFORMAL COATING FOR MOISTURE PROTECTION	TYPE: RELAY N.O.: 10A @ 120 VAC N.C.: 10 A @ 120 VAC	ON MAKE CUSTOM AVAILABLE, FIXED OR ADJUSTABLE	2.75 X 3.25	34.24
S1-ICM345	AUDIBLE/VISIBLE CONDENSATION ALARM ASC COMPRESSOR PROTECTION WORKS WITH ANY EXISTING THERMOSTAT OR CONDENSATION CONTROL	TYPE: RELAY N.O.: 1A @ 30 VAC	ANTI-SHORT CYCLE: 5 MIN. FIXED	4.5 X 2.75 X 0.875	62.94

ICM Lockout Protection



The S1-ICM221 is a low-cost compressor protection module that monitors safety switch inputs and provides anti-short cycle protection. S1-ICM220 and S1-ICM222 are low-cost lockout protection modules that monitor various switch inputs to help protect the compressor.

Specifications:

Voltage: 18–30 VAC

Frequency: 50–60 Hz

SOURCE 1 PART NO.	DESCRIPTION	DIMENSIONS (INCHES)	MLP \$
S1-ICM220	COMPRESSOR CONTROLLER, LOCKOUT RELAY IDEAL FOR USE WITH SAFETY/INTERLOCK SWITCHES 2 WATTS MAX. POWER CONSUMPTION @ LOCKOUT RELAY: 1 FORM C, CONTACTS: 2A @ 30 VAC RESISTIVE	2 X 2	38.46
S1-ICM221	COMPRESSOR PROTECTION MODULE WITH 1-SECOND INTERROGATION SAFETY SWITCH MONITORING 3 OR 6 SEC. DELAY ON MAKE, SELECTABLE 10 SEC. OR 5 MIN. ANTI-SHORT CYCLE TIME	3.25 X 3 X 1	61.24
S1-ICM222	LOCKOUT PROTECTION MODULE WITH PRESSURE/FLOW SWITCH MONITORING FAULT TYPE: RELAY (SPDT) N.O., FAULT RATING: 1A @ 30 VAC 5 MIN. FIXED ANTI-SHORT CYCLE TIME ±20% (5 SEC. TEST MODE)	3.5 X 3.25 X 1	61.24

HVAC Components

HARD START DEVICES

ICM Current Sensing Hardstarts



By monitoring the compressor current upon startup, ICM RapidStart® is able to engage the hard start capacitor for precisely the correct amount of time, ensuring maximum starting torque without the risk of supplying too much current into the start winding. A timed safety circuit is provided in the event the motor fails to start within 2 seconds.

Features:

- Operates from 95–288 VAC
- Patented current sensing circuitry
- Easy, 2-wire installation
- OEM-approved, Solid-state circuitry
- Boosts starting torque, Disengages upon start
- Recycles instantly (less than 1 second)
- Fuse protection

- Not affected by voltage or current fluctuations
- Not affected by ambient temperatures

Specifications:

Voltage: 95–288 VAC

Maximum Input Voltage: 502 VAC

Operating Temperature Range: -40°C to +65°C

SOURCE 1 PART NO.	APPLICATION	CAPACITOR	REPLACES	MLP \$
S1-ICM803	1/2-3 HP	88-106 MFD. 330 V	KICKSTART: T05, T0-5 SUPCO: SPP-8 SPP-8E	92.10
S1-ICM805	2-5 HP	145-175 MFD. 330 V	KICKSTART: KS1	95.95
S1-ICM810	3-1/2-10 HP	243-292 MFD, 330 V		106.56

Wiring Diagram Legend:

C = Common Terminal, R = Run Terminal, S = Start Terminal,
RC = Run Capacitor, RS = Rapid Start, SC = Start Capacitor

Maximum Input Voltage = 502 VAC RMS (maximum run capacitor volts)

Input Voltage = Run winding volts + Start winding volts

Note: Run capacitor voltage is higher than line voltage.

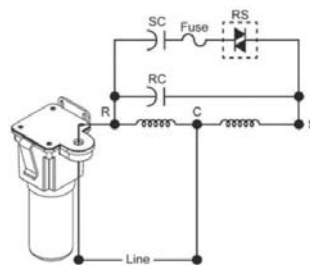

ICM 3-in-1 Hardstarts



Features:

- For single-phase commercial and domestic capillary refrigeration systems and freezers
- Pre-wired for fast installation

SOURCE 1 PART NO.	APPLICATION RANGE	OPERATING VOLTAGE	MAXIMUM		RETRY TIME	MLP \$
			VOLTAGE	CURRENT		
S1-ICM857	1/12 - 1/5 HP	120 V	180 V	12A	WITHIN 90 SECONDS	31.25
S1-ICM858	1/4 - 1/3 HP	120 V	180 V	12A	WITHIN 90 SECONDS	31.25
S1-ICM859	1/3 - 1/2 HP	120 V	180 V	12A	WITHIN 90 SECONDS	44.51

ICM PTCR Hardstart Capacitors



Features:

- Increases starting torque
- Positive Temperature Coefficient (PTC) Technology
- Easy to install
- Low cost motor starting device

SOURCE 1 PART NO.	VOLTAGE	RANGE	CAPACITOR	MLP \$
S1-ICM855	115-288 VAC	0.5-1.5 HP	43 TO 52 MFD, 330 V	21.38
S1-ICM856	115-288 VAC	2.0 - 5.0 HP	88 TO 106 MFD, 330 V	27.84

HVAC Components

HARD START DEVICES

Hard Start Kit

ICM866U



The ICM866U combines the award-winning technology of ICM's Universal Motor Starting Relay with the patented circuitry of the ICM860 for the most precise and reliable hard start kit on the market! Rated for 1/12 to 5HP applications.

Specifications:

- Multi-voltage operation – 115 or 230 VAC motors
- Recommended Range: 1/12 to 5HP application
- 145-175 μ F @ 330V
- UL Recognized

SOURCE 1 PART NO.	DESCRIPTION	MLP \$
S1-ICM866U	HARD START, VOLT SENS, 0.5-5.0 HP, 145-175 μ F	77.08

ICM Voltage Sensing Hardstarts



Features:

- Differential voltage sensing
- The best technology competitively priced
- Reduces inventory
- Ensures precise starts
- Increases starting torque
- Not effected by ambient temperature
- Recycles instantly (less than 1 second)
- Multi-voltage operation either 115 or 230 VAC motors



SOURCE 1 PART NO.	VOLTAGE	MAXIMUM INPUT VOLTAGE	RANGE	OPERATING TEMPERATURE RANGE	CAPACITOR	REPLACES	MLP \$
S1-ICM850	90 TO 277 VAC	390 VAC	UP TO 1 1/2 HP	-40°C TO +65°C	43 TO 52 MFD. 330V	SUPCO SPP-5, MARS 32701, A-1 WXS-5	44.19
S1-ICM860	90 TO 277 VAC	390 VAC	2 TO 5 HP	-40°C TO +65°C	88 TO 106 MFD. 330V	SUPCO SPP-6, MARS 32702, A-1 WXS-6	58.69

FREEZE PROTECTION & DEFROST CONTROLS

White Rodgers Freeze Protection Control Board

Universal Heat Pump Defrost Control



White Rodgers

Universal Heat Pump Defrost Control

Replaces Virtually All Single Stage Defrost Controls. Introducing the industry's first universal heat pump defrost control. The latest in outdoor electronic innovations from White-Rodgers is a universal upgrade for single stage heat pump systems with a PSC fan motor. Select from pre-configured demand or timed defrost routines or configure to replicate virtually any set up.

Electrical Ratings:

Control Voltage: 24 VAC 50/60 Hz
Line Voltage: 208/240 VAC 50/60 Hz

Input Ratings:

Outdoor PSC Fan: 0.5 HP @ 240 VAC, 0.125HP @ 120 VAC
Compressor Coil: 24 VAC
Aux Heat (D|W|X2): 24 VAC

Reversing Valve: 24 VAC

Operating Temperature Range:

-40° to 150° F (-40° to 65° C)

Humidity Range:

0-95% relative humidity, non-condensing

Dimensions / Mounting:

5.75"W x 4.72"L x 1.75" H

SOURCE 1 PART NO.	DESCRIPTION	MLP \$
S1-47D01U-843	CNTRL,BOARD,DEFROST,HEATPUMP,UNIVERSAL	260.20

Defrost Controls

ICM350



The ICM350 Defrost Board is a 3-in-1 replacement board for Carrier HK32EA001, HKEA003, HK32EA008 boards. Special circuitry helps reduce noise disturbances when entering and exiting the defrost sequence on the 003 and 008 applications.

Specifications:

- **Voltage:** 18-30 VAC
- **Frequency:** 50/60 Hz
- **Power Consumption:** 1 Watt Maximum
- **Current Draw:** 300mA Maximum
- **Maximum Defrost Sequence:** 10 minutes

SOURCE 1 PART NO.	DESCRIPTION	MLP \$
S1-ICM350	DEFROST CONTROL BOARD	292.23

HVAC Components

FREEZE PROTECTION & DEFROST CONTROLS

ICM Freeze Protection Modules



Low-cost, fixed, single setpoint temperature controls that provide freeze protection.

Features:

- Epoxy encapsulated for moisture protection
- Temperature sensor included

Specifications:

Input Voltage: 18–30 VAC
 Input Frequency: 50–60 Hz
 Output: Solid state (triac), 1.5A @ 30 VAC
 Dimensions: 2" x 2" x 1-1/4"

SOURCE 1 PART NO.	TEMPERATURE CUT-OUT (OFF)	TEMPERATURE CUT-IN (ON)	MLP \$
S1-ICM308	43°F	45°F	33.80
S1-ICM309	28°F	55°F	33.80
S1-ICM310	44°F	48°F	33.80

ICM Timers & Controls



Specifications:

Input Frequency: 50/60 Hz
 Power Consumption: 1 watt maximum
 Output Type: Relay
 Defrost Time Delay: Fixed 10 minutes ±5%

Power on Reset Time: 500 milliseconds

Test Time: Short across test terminals reduces test time 256x
 Interval Time Between Defrosts (Pin-Selectable): 30/60/90 Min
 (Excluding S1-ICM316 and S1-ICM317)

SOURCE 1 PART NO.	APPLICATION	INPUT VOLT-AGE	OUTPUTS	MLP \$
S1-ICM300	HEAT PUMP DEFROST TIMER	18–30 VAC	RELAY, SPST, N.O., 1A	53.11
S1-ICM301	HEAT PUMP DEFROST TIMER	18–30 VAC	RELAY, SPST, N.O., 1A	53.11
S1-ICM302	DEFROST TIMER WITH HIGH POWER FAN RELAY OUTPUT	18–30 VAC	RATING: 1 AMP @ 30VAC	133.66
S1-ICM303C	HEAT PUMP DEFROST CONTROL	18–30 VAC	1HP FAN @ 240 VAC; 24 VAC 2A STRIP HEAT/REVERSING VALVE	151.83
S1-ICM304	HEAT PUMP DEFROST TIMER	18–30 VAC	W: RELAY, SPST, N.O., 10A @ 24 VAC RVS,CC: TRIAC, SPST, N.O., 10A @ 240 VAC FAN: RELAY, SPST, N.O., 10A @ 240 VAC	122.54
S1-ICM307	HEAT PUMP DEFROST TIMER	18–30 VAC	COMPRESSOR CONTACTS: TRIAC, 1A DEFROST RELAY: TRIAC, 1A	64.26
S1-ICM314	HEAT PUMP DEFROST CONTROL	18-30 VAC	TYPE: RELAY, RATING: 1 AMP @ 24VAC	212.97
S1-ICM315	SOLID STATE DEFROST CONTROL	24, 120 OR 240 VAC	N.O.: 20A N.C.: 10A @ 240 VAC	212.97
S1-ICM316	SOLID STATE DEFROST TIMER	18–30 VAC	O, X2: DPST, N.O., 1A @ 30 VAC ODF: SPDT, N.C., 1A @ 230 VAC EDR: PDT, N.C., 1A @ 30 VAC	166.26
S1-ICM317		18–30 VAC	RELAY, SPST, N.O., 1A	73.65
S1-ICM318	HEAT PUMP DEFROST TIMER	18–30 VAC	1/2 HP 240 VAC OUTDOOR FAN RELAY 24 VAC 1A STRIP HEAT REVERSING VALVE O, X2: DPST, N.O., 1A @ 30 VAC DF1, DF2: SPST, N.O., 1/2 HP @ 240 VAC	86.12
S1-ICM319	HEAT PUMP DEFROST TIMER	18–30 VAC	1/2 HP 240 VAC OUTDOOR FAN RELAY 24 VAC 1A STRIP HEAT REVERSING VALVE O, W2: DPST, N.O., 1A @ 30 VAC RESISTIVE T1, T2: SPST, N.O., 10A @ 24 VAC DF1, DF2: SPST, N.O., 1/2 HP @ 240 VAC	100.26
S1-ICM320	SOLID STATE DEFROST CONTROL	18–30 VAC	O, W2: DPST, N.O., 2A @ 24 VAC DF1, DF2: SPST, N.O., 10A @ 240 VAC	143.52
S1-ICM321	HEAT PUMP DEFROST TIMER	18–30 VAC	O, W2: DPST, N.O., 1A @ 30 VAC RESISTIVE T1, T2: SPST, N.O., 1A @ 30 VAC OF1, OF2: SPST, N.O., 1/2HP @ 240 VAC	128.08
S1-ICM322	HEAT PUMP DEFROST TIMER	18–30 VAC	O, W2: DPST, N.O., 1A @ 30 VAC T1, T2: SPST, N.O., 1A @ 30 VAC OF1, OF2: SPST, N.O., 1/2 HP @ 240 VAC	113.52
S1-ICM323	HEAT PUMP DEFROST CONTROL	18–30 VAC	24 VAC, 1A STRIP HEAT REVERSING VALVES	144.80
S1-ICM330	HEAD PRESSURE CONTROL	18–30 VAC	MAX: 4 AMPS, MIN: 100mA	364.29
S1-ICM550C-LF	DEFROST TIMER	120-240 VAC	COMPRESSOR/DEFROST HEATER: RELAY, SPST, N.O., RATING: 40A @ 240 VAC. FAN: RELAY, SPST, N.C., RATING: 30A @ 240 VAC	364.29

AIR CONDITIONING & HEATING CONTROLS

MOTOR PROTECTION

ICM 3-Phase Motor Protection



Protects Against:

- Under voltage
- Over temperature
- Power interruptions
- Rapid short cycling
- Shorted temperature sensor
- Open temperature sensor
- Control duty, SPST relay layout
- Anti-short cycle time delay, 4 min. (nominal)
- 1-second manual bypass

Specifications:

Voltage: 120 or 208/240 VAC
Frequency: 50–60 Hz
Output: Relay: SPDT N.O. 6A resistive
Dimensions: 3.25" x 3" x 1.25"

SOURCE 1 PART NO.	DESCRIPTION	MLP \$
S1-ICM441	BRISTOL: 241680, COPELAND: 071-0376-01, 071-0376-02, 071-0397-00, 071-0397-01.071-0424-00, 071-0424-01.071-9800-00, 071-9800-01 MARS: 37300, 37302, 37304, 37306, 37322 TEXAS INSTRUMENTS: 15AA 1600 B, 15AA 1600 C, 15AA 1603 B, 15AA 1603C, 31AA 1600 E, 3	194.52

ICM Universal Motor Starting Relays



Features:

- Replacement for all standard potential relays
- Patented differential voltage sensing
- No user adjustments required
- Non-positional mounting configuration
- 30A and 50A switching capabilities
- Universal mounting bracket for easy installation
- 0.250" quick-connect termination
- Safety timer
- Approvals: UL, CSA, cUL pending

Specifications:

Input:

Voltage Rating: 110–270 VAC, Single Phase

Maximum Voltage Contact Rating: 502 VAC (absolute)

Motor Power Rating: Up to 10 HP

Operating Position: Non-positional

Safety Time Out: Approximately 1 second per 100 microfarads

Consumption: 5VA max.

Insulation: Class B (130°C); Conforms to IEC 1000 standards

(6kV impulse / 6kV contact)

Life Expectancy (minimum operations):

Mechanical: 1 x 106

Electrical: 1 x 106 at 16A 400VAC

5 x 105 at 35A 400VAC (break only)

5 x 105 at 50A 400VAC (break only)

Contact Rating:

30A (break only), 400VAC cos ϕ = 0.7 to 0.8

50A (break only), 400VAC cos ϕ = 0.7 to 0.8

SOURCE 1 PART NO.	ICM PART NO.	MLP \$
S1-UMSR-50	UMSR-50	45.39

HVAC Components

MOTOR PROTECTION

CC750 Comfort Control Center



ICM's award-winning CC750 Comfort Control Center works with your existing air conditioning system or heat pump to improve its effectiveness at air moisture removal, while creating greater system efficiencies that help promote energy

Ratings:

- Nominal 24 VAC inputs ($\pm 25\%$): 18-30 VAC RMS absolute
- Operating temperature: -40°F to $+167^{\circ}\text{F}$ (-40°C to $+75^{\circ}\text{C}$)
- Power consumption: 10 watts typical

Line Ratings – Nominal 115 VAC RMS:

- Inverter operation: 95-135 VAC RMS absolute

- Bypass operation: 85-145 VAC RMS absolute
- Maximum inverter amps: 10 amps RMS
- Maximum bypass amps: 20 amps (60 Hz)

Line Ratings – Nominal 208-230 VAC RMS:

- Inverter operation: 180-264 VAC RMS absolute
- Bypass operation: 170-264 VAC RMS absolute
- Maximum inverter amps: 8.5 amps RMS
- Maximum bypass amps: 10 amps (60 Hz)

SOURCE 1 PART NO.	DESCRIPTION	MLP \$
S1-CC750-115	CC750 COMFORT CONTROL CENTER, 115VAC	656.02
S1-CC750-230	CC750 COMFORT CONTROL CENTER, 230VAC	656.76
S1-PTB47	COIL SENSOR FOR USE W/ CC750	70.68
S1-RSN20	RETURN SENSOR FOR USE W/ CC750	70.68

RELAY

Emerson SureSwitch Relay



SureSwitch™ Relay is a universal electronic upgrade and a superior replacement for mechanical compressor contactors.

5 Reasons to Install SureSwitch relay:

- 1. Pest Protection:** Totally sealed relay to keep out ants and debris; no pest control treatments needed.
- 2. 5x Life vs. Traditional Contactor:** Microprocessor control nearly eliminates contact damage.
- 3. No Noise:** Latching internal relay won't hum or buzz.
- 4. Time Delays:** Protects system when re-starting between regular cycles or after power interruptions.
- 5. Low Voltage Brownout Protection:** Detects and protects system from low voltage events that can cause compressor and fan motors to overheat and fail prematurely.

SOURCE 1 PART NO.	DESCRIPTION	MLP \$
S1-49P11-843	SURESWITCH RELAY FOR UP TO 40A, 208/240V. 1 OR 1.5 POLE APPLICATIONS	137.49

FAN RELAY

Source 1 Enclosed Fan Relays - 90-290Q thru 90-295q WR/RBM Type 84

Single Pole Single Throw Normally Open (SPST-NO)

SOURCE 1 PART NO.	COIL VOLTAGE (50/60 HZ)	MLP \$
S1-S90-290Q	24	15.12
S1-S90-291Q	120	14.72
S1-S90-292Q	240	14.72

*Can be used as an isolation relay for digital thermostats when required.

Single Pole Double Throw (SPDT)

SOURCE 1 PART NO.	COIL VOLTAGE (50/60 HZ)	MLP \$
S1-S90-293Q	24	15.60
S1-S90-294Q	120	15.69
S1-S90-295Q	240	15.60

*Can be used as an isolation relay for digital thermostats when required.

HVAC Components

FAN RELAY

Source 1 Enclosed Fan Relays - 90-290Q thru 90-295q WR/RBM Type 84

Single Pole Single Throw Normally Open (SPST-NO)

CONTACT RATING 125/250 VAC	
INDUCTIVE	RESISTIVE
8 AMPS CONTINUOUS 25 AMPS INRUSH	16 AMPS CONTINUOUS

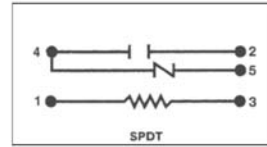
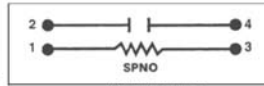

Cross Reference Guide		
MARS NO.	SOURCE 1 PART NO.	ALTERNATE SOURCE 1 NO.
90290	S1-S90-290Q	S1-S90-360
90291	S1-S90-291Q	S1-90-362
90292	S1-S90-292Q	S1-90-364
90293	S1-S90-293Q	S1-S90-370
90294	S1-S90-294Q	S1-90-372
90295	S1-S90-295Q	S1-90-374

Source 1 Enclosed Fan Relays - 90-360 Thru 90-484 WR/RBM Type 184

Single Pole Normally Open (S.P.N.O)

SOURCE 1 PART NO.	COIL VOLTAGE (50/60 HZ)	COIL DATA				MLP \$
		RES.	NOM CURRENT MA	NOM. VA SEALED	INRUSH VA	
S1-S90-360	24	77	125	3	4	15.09

Single Pole Double Throw (S.P.D.T.)

SOURCE 1 PART NO.	COIL VOLTAGE (50/60 HZ)	COIL DATA				MLP \$
		RES.	NOM CURRENT MA	NOM. VA SEALED	INRUSH VA	
S1-90-372	120	1,800	25	3	4	12.36
S1-90-374	208/240	7,000	12.5	3	4	15.60
S1-S90-370	24	77	125	3	4	15.90

Isolated Contacts (S.P.N.O./S.P.N.C.)

SOURCE 1 PART NO.	COIL VOLTAGE (50/60 HZ)	COIL DATA				MLP \$
		RES.	NOM CURRENT MA	NOM. VA SEALED	INRUSH VA	
S1-S90-380	24	77	125	3	4	15.90
S1-S90-384	208/240	7,000	12.5	3	4	15.90

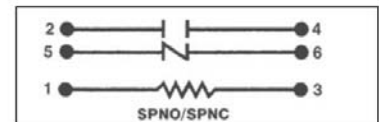
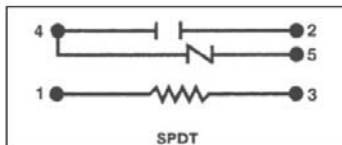
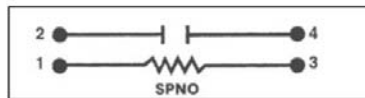

Wiring Diagrams

HVAC Components

FAN RELAY

Source 1 2 Pole Switching Relays - S1-90-340 Thru S1-90-342 WR/RBM Type 91

Two Pole Double Throw (2P.D.T.) Fits Receptacles



A two pole double throw semi-enclosed relay. Easy to install and wire. Relay available for power or pilot duty. Suited for vending machines, appliances, fan controls, heating and air conditioning applications and general purpose switching.

Features:

- Temperature Range: -40°F to 130°F
- Mechanical Life (no load): 750,000 operations, 30 operations per minute
- Electrical Life (rated load):
 - 100,000 operations, 6 operations per minute
 - Load test making inrush ratings (0.4 to 0.5 P.F.); breaking 100% continuous rating-(0.65 to 0.8 P.F.)
- Weight (approximate): 6 oz.

Coils

- Frequency: 50/60 Hz
- Class Insulation: B
- Termination: 1/4" quick connect
- Operate: 85% of nominal coil voltage; 110% maximum safe operate
- Duty Cycle: continuous

SOURCE 1 PART NO.	COIL VOLTAGE (50/60 HZ)	TERMINALS 1-2-3	TERMINALS 4-5-6	COIL DATA				MLP \$
				DC RES.	MA	NOM. VA	INRUSH VA	
S1-S90-340	24	POWER	POWER	15	334	8	22	19.56
S1-S90-341	110/120	POWER	POWER	400	66	8	22	19.59
S1-S90-342	208/240	POWER	POWER	1415	38	8	22	19.59

CONTACT RATING (PER POLE)				
A.C. VOLTAGE	POWER		PILOT	
	INDUCTIVE	RESISTIVE	INDUCTIVE	RESISTIVE
125	13.8 A 1/2 H.P. 13.8 A FULL LOAD 82.8 A INRUSH	15 A	1/10 H.P. 125 V.A.	3 A
250	1/2 H.P. 6 A FULL LOAD 35 A INRUSH 15 A	15 A	1/10 H.P. 125 V.A.	3 A
277	@ 75% P.F. (POWER FACTOR)	15 A	--	3 A

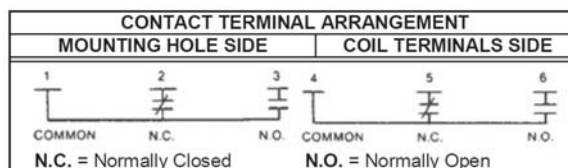

FAN COIL RELAY CONTROLS

ICM6200 Fan Coil Relay Control



Fan coil relay control center for operating line voltage, 3-speed fan motor with low voltage controls; For 2- or 4-pipe, heat pump, autochangeover applications.

Specifications:

Input:

- Transformer Primary: 115 VAC, 50-60 Hz
- Fan Inputs HI, MED, LOW: Nominal 17mA @ 24 VAC
- Heat & Cool: 1.5A @ 24 VAC

Output:

- Transformer Secondary: 24 VAC; 20 VA
- Relay Outputs HI, MED, LOW: 1/8 HP @ 115 VAC; 10A @ 240 VAC resistive max.
- Heat & Cool Valves: 1.5A @ 24 VAC

SOURCE 1 PART NO.	DESCRIPTION	STD. PACK	MLP \$
S1-ICM6200	ICM6200 FAN COIL RELAY CONTROL	10	183.81

HVAC Components

FAN COIL RELAY CONTROLS

ICM6201 Fan Coil Relay Control



Fan coil and electric heat control center for operating line voltage, 3-speed fan motor with low voltage controls; For 2- or 4-pipe, aquastat auto-changeover, heat pump applications.

Specifications:

Input:

- Transformer Primary (L1 & L2): 115 VAC, 50-60 Hz
- HI, MED, LOW (8, 7, 6): Nominal 17mA @ 24 VAC
- Inputs 1-5, Aqua Heat & Cool: 1.5A @ 24 VAC

Output:

- Transformer Secondary: 24 VAC; 20 VA
- Relay Outputs HI, MED, LOW: 1/8 HP @ 115 VAC; 10A @ 240 VAC resistive
- HTR Output: 30A @ 240 VAC resistive
- Heat & Cool Valves: 1.5A @ 24 VAC

SOURCE 1 PART NO.	DESCRIPTION	STD. PACK	MLP \$
S1-ICM6201	ICM6201 FAN COIL RELAY CONTROL	10	200.54

TIME DELAYS

ICM Fixed Delay Time Delays



Features:

- Works with anticipator type thermostats
- Higher 1.5 amp power rating
- Simple, 2 wire hookup
- Compact 2" x 2" package

Input:

- Control Voltage: 18–30 VAC
- Frequency: 50/60 Hz
- Power Consumption: 2 watts max. during timing

Output:

- Ratings: max. 1.5 amps, min. 40 µa, inrush 15 amps
- Voltage Drop: 2.5 VAC max @ 1.5 amps on make timers; 4.5 VAC max @ 1.5 amp, 3 amps typical on break timers
- Bypass resistor: <1 K @ 24 VAC

Mechanical:

- Mounting: surface mount using (1) #8 or #10 screw

Environmental:

- Operating temperature: –40° to +75°C, –40° to +167°F
- Transient protection: meets IEEE 587 standards for categories A & B without false output or degradation. (6kv 0.5 µs x 100 Khz ring wave, 6kv 1.2 x 50 µs impulse wave)

SOURCE 1 PART NO.	MFG. NUMBER	TIME DELAYS	DELAYS	MLP \$
S1-ICM100	ICM100	3 MIN		17.96
S1-ICM100F	ICM100F	3 MIN	ON MAKE	17.52
S1-ICM101	ICM101	5 MIN		25.57
S1-ICM101F	ICM101F	5 MIN	ON MAKE	17.52

* F Suffix Denotes 6" wire leads

TIME DELAYS

ICM Adjustable Delay Time Delays



Features:

- Knob-adjustable time delays
- Higher 1.5 amp power rating
- Simple, 2 wire hookup
- Compact 2" x 2" package
- Works with anticipator type thermostats
- Spin proof knob
- 6" wire leads

Input:

- Control Voltage: 18–240 VAC
- Frequency: 50/60 Hz
- Power Consumption: 2 watts max. during timing

Output:

- Ratings: max. 1.5 amps, min. 40 µa, inrush 15 amps
- Voltage Drop: 2.5 v max @ 1.5 amps on make timers; 4. v max @ 1.5 amp, 3 amps typical on break timers
- Bypass resistor: <1 K @ 24 VAC

Mechanical:

- Mounting: surface mount using (1) #8 or #10 screw

Environmental:

- Operating temperature: -40° to +75°C, -40° to +167°F
- Transient protection: meets IEEE 587 standards for categories A & B without false output or degradation. (6 Kv 0.5 µs x 100 Khz ring wave, 6 Kv 1.2 x 50 µs impulse wave)

SOURCE 1 PART NO.	MFG. NUMBER	TIME DELAYS	DELAY	MLP \$
S1-ICM102	ICM102	0.03–10 MIN. (1.8–600 SEC.)		19.68
S1-ICM102F	ICM102F	0.03–10 MIN. (1.8–600 SEC.)	ON MAKE	17.52
S1-ICM103	ICM103	1–1023 SEC.		36.83
S1-ICM104	ICM104	10–1000 SEC.		72.38
S1-ICM105	ICM105	1.8–600 SEC.		30.39

* F Suffix denotes 6" wire leads

ICM Bypass Timers Series 175



Low pressure or oil switch bypass during startup, ideal for low ambient startups, integral component for "winter start" kits...The Series 175 may be used as an integral component in "winter start kits", ideal for bypassing switches and for low ambient startups.

- 18-240 VAC operation
- Extends on-time switch closures
- Knob-adjustable delays: .01-1,000 sec.
- Precise digital timing circuitry
- One model replaces several in field
- Compact 2" x 2" package
- Epoxy-encapsulated circuitry
- Recognized: E53944 certified: LR 30320

Used to bypass a control or device during startup. Typically used to bypass a low pressure switch during compressor heat pump startup or to bypass an oil pressure switch upon startup. Ideal in low ambient conditions. Integral component for "winter start" kits.

Helps to eliminate nuisance lockouts.

With power applied to the input, the load is energized immediately and remains energized for the length of the time delay. At the end of the time delay, the condition of the load is determined by the state of the bypassed switch.

Specifications:

Input

- Control voltage: 18-240 VAC
- Frequency: 50/60 Hz
- Power consumption: 3 watts max.

Output

- Ratings: max. 1 amp, min. 40 µa, inrush 10 amps
- Voltage drop: 2.5 V max. @ 1 amp
- Leakage current: 5 µa max. @ 240 VAC

Time Delay

- Type: knob adjustable
- Range: 10-1,000 sec.
- Tolerance: 20% of selected time

- Operating temperature: -40° to +75°C, -40° to +167°F
- Transient protection: meets IEEE 587 standards for categories A & B without false output or degradation. (6Kv 0.5 µs x 100 KHz ring wave)(6Kv 1.2 x 50 µs impulse wave)

Mechanical Mounting: surface mount using (1) #8 or #10 screw

Environmental

SOURCE 1 PART NO.	MFG. NUMBER	MLP \$
S1-ICM175	ICM175B/GPS00C2X1000P	33.36

TIME DELAYS

ICM Delay On Break Timers



Features:

ICM's Delay on Break (DOB) Timers are low cost, direct OEM replacements that offer reliable, lasting protection for your HVACR equipment. Provide anti-short cycle protection for your air conditioning, refrigeration and heat pump equipment. Each unit features rugged, compact packaging and high power relays. UL listed. Choose from our extensive product selection to best meet the needs of your application.

S1-ICM200, S1-ICM200F, S1-ICM201, S1-ICM201F



- Compressor lockout/anti-short cycle timer
- Helps to protect compressors from damage
- Caused by rapid short cycling
- Simple, 2-wire hookup
- Fixed timing
- 18-30 vac

SOURCE 1 PART NO.	TIME DELAYS	REPLACES	MLP \$
S1-ICM200	3 MIN.	A-1: EAC-501-180-W DIVERSIFIED: AC-100-3 SUPCO: TD733	17.96
S1-ICM200F	3 MIN.	A-1: EAC-500 SUPCO: TD733W	18.80
S1-ICM201	5 MIN.	A-1: EAC-500, EAC-501-300-W DIVERSIFIED: ACS-500-5 SUPCO: TD735	17.96
S1-ICM201F	5 MIN.	A-1: EAC-500, EAC-501-300-W DIVERSIFIED: AC-505-5 SUPCO: TD735W	18.80

S1-ICM203, S1-ICM203F



- Compressor lockout/anti-short cycle timer
- Helps to protect compressors from damage
- Caused by rapid short cycling
- Simple, 2-wire hookup
- Adjustable timing
- Universal voltage

SOURCE 1 PART NO.	TIME DELAYS	REPLACES	MLP \$
S1-ICM203	0.03–10 MIN. (1.8–600 SEC.) KNOB-ADJUSTABLE	A-1: EAC-501-ADJ DIVERSIFIED: AC-503 MARS: 32092, 32392 ROBERTSHAW: 3310-072 SUPCO: TD-73 WAGNER/Diversitech: ADB-1	19.68
S1-ICM203F	0.03–10 MIN. (1.8–600 SEC.) KNOB-ADJUSTABLE	SUPCO: TD73W WAGNER/Diversitech: ADB-2	19.68

S1-ICM204, S1-ICM205, S1-ICM206



- Compressor lockout/anti-short cycle timer
- Brownout protection
- UI 873 recognition as compressor controller
- Helps prevent scroll compressor reversal
- 18-30 vac

SOURCE 1 PART NO.	TIME DELAYS	REPLACES	MLP \$
S1-ICM204	3 MIN.	A-1: EAC-426-180 DIVERSIFIED: AC-100-3 MARS: 32381, 32565 ROBERTSHAW: 3310-183 SUPCO: TL243	21.82
S1-ICM205	5 MIN.	A-1: EAC-426-300 DIVERSIFIED: AC-100-5 MARS: 32382 ROBERTSHAW: 3310-305 SUPCO: TL245	21.82
S1-ICM206	3-10 MIN. ADJUSTABLE	A-1: EAC-426-ADJ	21.82

S1-ICM207, S1-ICM208, S1-ICM209



- Compressor lockout/anti-short cycle timer.
- Helps prevent scroll compressor reversal.
- Works with anticipator-type thermostats.
- Fixed or adjustable timing.
- Universal voltage operation.

SOURCE 1 PART NO.	TIME DELAYS	REPLACES	MLP \$
S1-ICM207	3 MIN.	A-1: EAC-426-180 DIVERSIFIED: AC-100-3 MARS: 32381 ROBERTSHAW: 3310-183 SUPCO: TL243	23.09
S1-ICM208	5 MIN.	A-1: EAC-426-300 DIVERSIFIED: AC-100-5 MARS: 32382 ROBERTSHAW: 3310-305 SUPCO: TL245	23.09
S1-ICM209	3-10 MIN. ADJUSTABLE	A-1: EAC-426-ADJ	25.68

TIME DELAYS

ICM Delay On Break Timers

S1-ICM211



- UI 873 recognition as compressor controller
- Compressor lockout/anti-short cycle timer
- Low cost, open board package
- Conformally coated for added protection
- Fixed timing
- 18-30 vac

SOURCE 1 PART NO.	TIME DELAYS	REPLACES	MLP \$
S1-ICM211	5 MIN.	N/A	23.09

S1-ICM210, S1-ICM212



- UI 873 recognition as compressor controller
- Compressor lockout anti-short cycle timer plus
- Random start function
- Dual function delay on make/break
- Random start delay is ideal for stagger-starting
- Multiple units
- Fixed timing
- 18-30 vac
- Plastic standoffs (S1-ICM212)

SOURCE 1 PART NO.	TIME DELAYS	REPLACES	MLP \$
S1-ICM210	5 MIN.	A-1: EAC 650	27.40
S1-ICM212	5 MIN.	A-1: EAC 650	27.40

ICM Random Start Timers



Ideal for use in compressor staging and to stagger-start multiple rooftop units. Helps to reduce power surges.

Features:

- Delay on make/delay on break
- UL 873 recognition as compressor controller
- Compressor lockout/anti-short cycle timer
- Integral random start capability
- Knob-adjustable time delay

Specifications:

Voltage: 18–30 VAC
Current: 1A maximum; 40mA minimum
Inrush: 10A

SOURCE 1 PART NO.	ADDITIONAL FEATURES	TIME DELAYS	DIMENSIONS (INCHES)	REPLACES	MLP \$
	SPST, N.O.	6-600 SEC. VOLTAGE DROP 1.5V @ 1A	2 X 2	DIVERSIFIED: ASC-200	41.52
S1-ICM151	SAFETY SWITCH LOCKOUT; REMOTE THERMOSTAT RESET	-0.1 THRU 600 SEC.	2 X 3	BARD: 8201-088 CARRIER: HN67KZ002 YORK: 031-01204-000	71.95

ICM Duty Cycle Timers



Features:

- Duty cycle timer ideal for defrost applications
- Suitable for process equipment or applications requiring intermittent delays
- Switch-settable time delays
- Epoxy-encapsulated for greater reliability
- On time starts at power up.

Specifications:

Voltage: 18–240 VAC 1A
Inrush: 10A
Dimensions: 2" x 3"

SOURCE 1 PART NO.	TIME DELAYS	MLP \$
S1-ICM305	SWITCH-SETTABLE FROM 1-1023 MIN. IN 1-MIN. INTERVALS	81.81
S1-ICM306	SWITCH-SETTABLE FROM 1-1023 SEC. IN 1-SEC. INTERVALS	82.66

TIME DELAYS

ICM Post-Purge Fan Delay Timers Series 251, 252, 253, 254 & 255



Adjustable OFF delay timer, controls the circulating fan in heat pump, and AC forced air systems...

The Series 253 provides reliable OFF delay timing in a rugged package. The OFF delay is knob-adjustable from 12-390 sec.

- Knob-adjustable OFF delay: 12-390 sec.
- OFF delay purges ducts of residual air at the end of the heating/cooling cycle
- Helps increase overall system efficiency
- Epoxy-encapsulated circuitry
- Solid state reliability
- Low cost
- recognized: E118867 certified: LR 30320
- Controls the circulating fan in heat pump, air conditioning & forced air systems. OFF delay timing function continues to run the fan at the end of the heating/cooling cycle, thereby purging ducts of residual air and increasing system efficiency.
- Power must be applied before and during the time delay period. When the initiate contact closes, the load energizes and remains energized as long as the initiate contact is closed. The time delay begins when the initiate contact opens. At the end of the time delay period, the load is turned off. If the initiate contact recloses during the time delay period the load remains energized and the time delay is reset to zero. Removal of input power during the delay turns off the load and resets the time delay to zero. A one second interrogation delay is provided to avoid nuisance trips due to thermostat bounce or tampering.

Specifications:

Input

- Control voltage: 18-30 VAC
- Frequency: 50/60 Hz
- Power consumption: 2 watts max.

Output

- Ratings: max. 1 amp, min. 40 µa, inrush 10 amps
- Voltage drop: 1.25 V max. @ 1 amp

Time Delay

- Type: knob-adjustable only
- Range: OFF delay: 12-390 sec.

Mechanical Mounting: surface mount using (1) #8 or #10 screw

Environmental

- Operating temperature: -40° to +75°C, -40° to +167°F
- Transient protection: meets IEEE 587 standards for categories A & B without false output or degradation (6Kv 0.5 µs x 100 KHz ring wave)(6Kv 1.2 x 50 µs impulse wave)

SOURCE 1 PART NO.	REPLACES	MLP \$
S1-ICM251	MARS: 32377, 32378, 32379	64.26
S1-ICM253	FIELD CONTROLS: 46144700 GEMLINE: 1C216 MARS: 32393	47.10
S1-ICM254	HONEYWELL: S876A1016 WATSCO: PSTD-000-005W, PSTD-000-060W	51.40
S1-ICM255	A-1: 5893 BARD: 8201-056 MARS: 32393 RHEEM: 42-22515-01, 42-22515-02, 42-22515-03 SNYDER GENERAL/ICP: 1395336	39.26

ICM Fan Safety Alarm Circuit Control



Fan safety alarm circuit for air handling unit safety-shutdown

Specifications:

- Input: 24 VAC; 50-60 Hz (4A max.)
- Output:
 - Relay Outputs (6): 2A @ 24 VAC/DC per output
 - Master Relay 24 VAC (2): 1.5A @ 24 VAC per output
 - Master Relay Dry Contacts: 10A @ 250 VAC
- Alarm Status:
 - Green LED ON = Activated
 - Red LED ON = Not activated

SOURCE 1 PART NO.	REPLACES	STD PACK	MLP \$
S1-ICM6100	FAN SAFETY ALARM CIRCUIT CONTROL	10	254.09

HVAC Components

FAN BLOWER CONTROLS & FAN CONTROL CENTERS

ICM Fan Blower Control

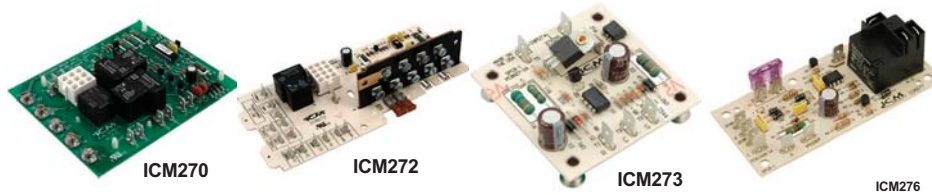

AIR CONDITIONING & HEATING CONTROLS

Specifications:

Voltage: 18–30 VAC

SOURCE 1 PART NO.	DESCRIPTION	CONTACT RATINGS OR OUTPUT	TIME DELAYS	MLP \$
S1-ICM270	DUAL FUNCTION FAN DELAY TIMER	HEAT/COOL SPEED N.O.: 20A @ 240 VAC N.C.: 10A @ 240 VAC	BLOWER ON: 30 SEC. BLOWER OFF: 90, 120, 150, 180 SEC.	144.80
S1-ICM272	COOLING CONTROL MODULE WITH FAN DELAY	N.O. 20A, N.C.: 10A	BLOWER OFF: 60 SEC.	108.81
S1-ICM273	CIRCULATING FAN CONTROL FOR HEAT PUMP, A/C AND FORCED AIR SYSTEMS	OUTPUT: 2A @ 240 VAC	BLOWER OFF: 60 SEC.	59.97
S1-ICM274	MICROPROCESSOR-BASED FAN BLOWER CONTROL	OUTPUT: Y OUT: 1.5A FAN: 2A ELECTRIC HEAT RELAY: 30A @ 240 VAC	BLOWER OFF: 60 SEC.	133.66
S1-ICM277	MICROPROCESSOR-BASED CIRCULATING FAN CONTROL IN HEAT PUMP, A/C AND FORCED AIR SYSTEMS	N.O.: 20A, N.C.: 10A	BLOWER ON: 7 SEC. BLOWER OFF: 65 SEC.	82.66

Replaces:

SOURCE 1 PART NO.	RHEEM	CARRIER	TEXAS INSTRUMENTS	EMI	ROBERTSHAW	GOODMAN
S1-ICM270	47-22827-01 47,22827-81/82 47-22828-01/02	--	--	--	--	--
S1-ICM272	--	HK61GA001 HK61GA003	2FD-1	--	--	--
S1-ICM273	--	--	--	240000-969	--	--
S1-ICM274	--	--	--	240-1764	--	--
S1-ICM276	47-23619-02 47-23619-03	HK51GA003	--	--	457-23619-03 RS100-833-02	--
S1-ICM277	--	--	--	--	--	B13707355125

HVAC Components

FAN BLOWER CONTROLS & FAN CONTROL CENTERS

AIR CONDITIONING & HEATING CONTROLS

ICM Fan Control Center ICM271



Features:

- Solid state fan blower
- Specifically designed to replace popular gas furnace centers
- Pin selectable blower delays
- High power, relay output
- Dual function fan delay timer
- Controls the circulating fan in heat pump, A/C and forced air systems
- OFF delay purges ducts for residual air
- ON delay allows air to reach the proper comfort level prior to energizing the fan

SOURCE 1 PART NO.	REPLACES	INPUT		CONTACT RATINGS	FIXED TIME DELAYS	MLP \$
		VOLTAGE	FREQUENCY			
S1-ICM271	FAN CONTROL CENTER	18-30 VAC	50/60 HZ	N.O.: 20A N.C.: 10A	ON: 75 SEC. OFF: 105 SEC.	140.94

Replaces:

ROBERTSHAW	CARRIER
695-100	302075-3, CES0110017, CES0110018, HH84AA010, HH84AA011, HH84AA012, HH84AA013, HH84AA020, P771-7002

ICM Fan Control Center ICM275



Features:

- Microprocessor-based fan blower control
- Built in humidity relay
- Manually adjustable post-purge off delay from 60–240 seconds
- Electronic air cleaner output
- Replaces: Robertshaw 695-101

SOURCE 1 PART NO.	REPLACES	INPUT		CONTACT RATINGS	FIXED TIME DELAYS	MLP \$
		VOLTAGE	FREQUENCY			
S1-ICM275	FAN CONTROL CENTER	18-30 VAC	50/60 HZ	20A @ 240 VAC ON HIGH 10A @ 240 VAC ON LOW	ON: 60 SEC. FIXED OFF: 60–240 SEC. ADJUSTABLE	145.68

Steveco Fan Control Centers



A one package transformer and relay combination, for remote mounting. They incorporate the over/under bobbin wound energylimiting class 2 transformer and fan relay on a common plate for mounting on a standard four inch junction box.

For use in remote control circuits:

- Furnace and air conditioners
- Operation of relays, contactors and solenoids
- Temperature indicating and regulation equipment

Ease of installation

- Line voltage connections pre-wired
- Color coded pre-stripped leads
- Low voltage connections on terminal board

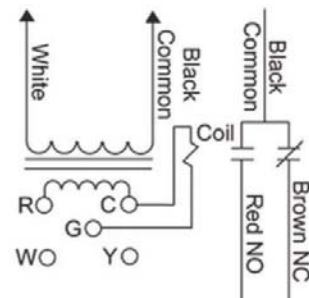

SOURCE 1 PART NO.	MARS NO.	TRANSFORMER PRIMARY		TRANSFORMER SECONDARY		RELAY	CONTACT RATINGS 120 VAC (AMPS)		CONTACT RATINGS 240 VAC (AMPS)		MLP \$
		VOLT	CONN	VOLT	CONN		FULL LOAD	LOCKED ROTOR	FULL LOAD	LOCKED ROTOR	
S1-90-112	24010	120V	COLOR CODED LEADS, PRE-STRIPPED	24V	TERMINAL BOARD WITH 5 SCREW TERMINALS	DPDT	13.8	82.8	6.9	41.4	104.76
S1-90-113	24013	120V	COLOR CODED LEADS, PRE-STRIPPED	24V	TERMINAL BOARD WITH 5 SCREW TERMINALS	SPDT	13.8	82.8	6.9	41.4	76.86

* Can be used as an isolation relay/transformer for multi-stage digital thermostats when required.

HEAD PRESSURE CONTROLS

ICM Head Pressure Controls with Heat Pump Bypass



Features:

- Integral Heat Pump Bypass Circuitry
- Allows you to electronically bypass the speed control during heat pump operation
- Solid state 10 amp load carrying capability
- Single unit controls up to 3 refrigerant circuits
- Multiple Voltage Ranges
- Hard Start
- Adjustable from .1-5 seconds; provides full torque to the motor during startup to help ensure proper fan rotation and lubrication of bearings
- Low Speed Cutoff
- Field-adjustable; user may set the minimum RPM level at which the condenser fan should operate
- High Temperature Bypass
 - Applies full voltage to the condenser fan under normal conditions
- Integral Transformer *(ICM326HN/327HN models) Simplifies installation, reduces cost; direct setup from the line voltage
- RoHs Compliant/Lead Free Design For global us Applications
- Ideal for “Low Ambient” Conditions Found in:
 - Supermarkets, frozen food storage
 - Computer rooms, cooling tower fans
 - Temperature/humidity-sensitive environment

Specifications:

- Frequency: 50/60 Hz
- Power Consumption: 4VA @ 24 VAC

Output

- Type: Solid State
- Form: Triac
- Output Current: (maximum: 10 amps) (minimum: 100 mA)
- Frequency: 50/60 Hz
- Voltage Drop: 3.0 volts maximum
- Leakage Current: 5 mA maximum

Protection

- Dielectric Breakdown: 2,500 volts maximum
- Insulation Resistance: 100 M

Control Operating Temperature

- Operating Temperature: -40°C to +75°C (-40°F to +176°F)
- Storage Temperature: -40°C to +85°C (-40°F to +185°F)

Dimensions

- ICM325HN: 43/4”L X 33/16”W X 11/8”H
- ICM326HN and ICM327HN: 43/4”L X 33/16”W X 13/4”H

Ordering Information

- Standard Model ICM325HN: 120-480 VAC
- Models with Integral Transformers: CM326HN: 120/208/240 VAC
ICM327HN: 480 VAC

SOURCE 1 PART NO.	DESCRIPTION	INPUT/OUTPUT VOLTAGE	MLP \$
S1-ICM325HN	ICM HEAD PRESSURE CONTROLS WITH HEAT PUMP BYPASS	120/208/240/480 VAC	255.40
S1-ICM325HNV-LF	ICM HEAD PRESSURE CONTROLS WITH HEAT PUMP BYPASS	600 VAC	306.40
S1-ICM326HM2	ICM HEAD PRESSURE CONTROLS WITH HEAT PUMP BYPASS	120 OR 208/240 VAC	381.37
S1-ICM326HN	ICM HEAD PRESSURE CONTROLS WITH HEAT PUMP BYPASS	120/208/240 VAC	309.83
S1-ICM327HN	ICM HEAD PRESSURE CONTROLS WITH HEAT PUMP BYPASS	480 VAC	324.33

ICM Head Pressure Controls with Temperature & Pressure Inputs and Optional Heat Pump Bypass



SOURCE 1 PART NO.	DESCRIPTION	PROBE CONNECTORS	MLP \$
S1-ICM333	ICM HEAD PRESSURE CONTROLS WITH TEMPERATURE AND PRESSURE INPUTS AND OPTIONAL HEAT PUMP BYPASS	2 TEMPERATURE PROBES, 2 PRESSURE PROBES	278.09

HVAC Components

HEAD PRESSURE CONTROLS

Three-phase ON/OFF Head Pressure Control



Specifications:

- Line voltage: 120-600 VAC
- Control voltage: 18-30 VAC
- Frequency: 50-60 Hz
- Operating Temperature: -40°F to +140°F (-40°C to +60°C)
- Heat Pump Override: 24 VAC, N.C./N.O.
- Probes:
- Ambient temperature Thermistor: 10K ohm at 77°F (25°C)
- Temperature: Thermistor, 10K ohm at 77°F
- Pressure: ICM380 (ordered separately)

SOURCE 1 PART NO.	DESCRIPTION	MLP \$
S1-ICM334C-LF	ICM 3-PHASE HEAD PRESSURE CONTROLS WITH SUPPORT FOR TWO PRESSURE OR TWO TEMPERATURE CONTROLS, IDEAL A/C AND REFRIGERATION SYSTEMS	278.09

ICM 3-Phase Head Pressure Controls

Accessories for ICM 3-Phase Head Pressure Controls



SOURCE 1 PART NO.	DESCRIPTION	FOR USE WITH	LENGTH (IN.)	PSI	MLP \$
S1-ICM380	OPTIONAL PRESSURE TRANSDUCER *	S1-IC336, S1-ICM337, S1-ICM330	72	0-500	184.25

* 1/4" SAE Female Flare with Schraeder deflator (6' long)

Probe for Head Pressure Controls with Optional Heat Pump Bypass Feature



SOURCE 1 PART NO.	DESCRIPTION	FOR USE WITH	LENGTH (IN.)	MLP \$
S1-ICM379	S1-ICM325H, S1-ICM326H, S1-ICM327H	6'7"	70°F-100°F, 21°-38°C	62.59

ENCLOSURE

ICM Controls Enclosure



Features:

- Rugged steel construction
- Easy to mount
- Helps to protect controls from harsh environmental conditions such as temperature, shock, humidity and vibration
- For use with ICM325HN, ICM326HN, ICM327HN, ICM332, and ICM333HN head pressure controls.

SOURCE 1 PART NO.	REPLACES	MLP \$
S1-ACC-OE-03	ENCLOSURE, WEATHERPROOF, FOR ICM325-ICM327	67.43

LINE MONITORS

ICM 3-Phase Voltage Monitor ICM400



Stop Motor Burnouts!

High performance, low cost model, front and back side protection, 7 bright fault LEDs, integral short-cycle protection, easy setup, fully adjustable features, 190-630 VAC...

The ICM400 was specifically designed to protect motors and other 3-phase loads from premature failure and damage due to common voltage faults such as voltage unbalance, over/under voltage, phase loss, reversal, incorrect sequencing and rapid short cycling.

3-Position Reset Switch, 50/60 Hz

- Choose from 3 easy-to-select reset modes:
- Full manual
- Full automatic
- Auto front/manual back
- Frequency: 50/60 Hz

Features:

- Bright LED's show modes and identify faults:
 - Load energized LED
 - Control voltage LED
 - Lockout LED
 - Front fault LED
 - Back fault LED
 - High voltage LED
 - Low voltage LED
- Knob-adjustable variables...user may easily select and adjust setpoints on unit:
- Voltage unbalance: 2-25%
- Delay on break period: 1-5 min.
- Fault interrogation: 1-15 sec.

Specifications:

Input

- Line voltage: universal- 190-630 VAC
- Frequency: 50/60 Hz

Contactors Load Side (Back)

- Line voltage: universal- 190-630 VAC

Load side monitoring is optional.

Output

- Type: relay
- Voltage range: 240 VAC (max: 10 amps)

Control Operating Temperature

- Operating temperature: -40° to +75°C, -40° to 167°F
- Storage temperature: -40° to +85°C, -40° to 185°F

Phase Unbalance Protection Voltage unbalance: 2-25% adjustable

Over/Under Voltage Protection

- Under/over voltage: fixed at 12%

Hysteresis: 6%

Low cost, high performance...full line protection and fault identification without costly LCD readout

Integral delay on break timer...knob-adjustable from 1-5 min., helps prevent rapid system recycling

Easy to install and configure... wiring diagram on unit, installation and application guide included

Phase Loss Protection Phase loss condition

= <25% of nominal for any given phase. System will shut down and a fault will be recorded should this condition occur.

Delay on Break Timer: Time delay: 1-5 min. adjustable

Fault Interrogation Delay

Time delay: 1-15 sec. Adjustable

Provides a delay between fault detection and system shutdown, eliminating nuisance trips/unnecessary shutdowns.

Mechanical

Mounting: surface mount using (2) #8 screws

Terminations: screw terminals

Weight: 12 ounces (341 grams)

Dimensions: 6.5" x 4.25" x 1.4"

AIR CONDITIONING & HEATING CONTROLS

SOURCE 1 PART NO.	DESCRIPTION	ICM PART NO	INPUT			OUTPUTS	MLP \$
			LINE VOLTAGE	FREQUENCY	CONTROL VOLT-AGE		
S1-ICM400	3-PHASE VOLTAGE MONITOR	ICM400	190-600 VAC	50/60 HZ	18-240 VAC/VDC	SPDT FREQUENCY: 50/60HZ	321.42

ICM 3-Phase Monitor ICM401



The ICM401 is a low cost 3-phase line monitor that protects against phase loss, phase reversal and phase unbalance. Ideally suited to protect scroll & screw compressors from reverse rotation.

Features:

- Low cost, single side 3-phase protection
- Bright LED indicators for fault and load energized
- Easy to install, no adjustments
- Wide operating range: 190-600 VAC
- Less than 1-second phase loss response
- Automatic reset from a fault condition
- Compact packaging: fits almost anywhere
- Rugged, epoxy-encapsulation for extreme conditions
- Works great with the ICM450 for load side monitoring of part winding start motors and multiple compressor systems

SOURCE 1 PART NO.	DESCRIPTION	INPUT		CONTROL VOLTAGE	OUTPUTS	MLP \$
		VOLTAGE	FREQUENCY			
S1-ICM401	3-PHASE LINE MONITOR	190-600 VAC	50/60 Hz	18-30 VAC	SPDT N.O. 10A	80.90

LINE MONITORS

ICM 3-Phase Monitor ICM402



The ICM402 is a low cost 3-phase line monitor, with a 30 amp output that protects against phase loss, phase reversal and phase unbalance. Ideally suited to protect scroll and screw compressors from reverse rotation. If all three phases are relatively equal and in proper sequence, the normally open contacts (Y/Y-OUT) will close when 115/230 volts is applied between C and 115/230 VAC terminals. If the phases are out of sequence, or if one is missing, the contacts will never close.

Features:

- Low cost, single side 3-phase protection
- 30 amp output
- Bright LED indicators for fault and load energized
- Easy to install; no adjustments
- Wide operating range: 190–600 VAC
- Less than 1 second phase loss response
- Automatic reset from a fault condition
- Compact packaging: fits almost anywhere
- Rugged, epoxy-encapsulation for extreme conditions
- Works well with the ICM450 for load side monitoring of part winding start motors and multiple compressor systems
- Dimensions: 3.0" x 3.25" x 1.25"

SOURCE 1 PART NO.	DESCRIPTION	INPUT		CONTROL VOLTAGE	OUTPUTS	MLP \$
		VOLTAGE	FREQUENCY			
S1-ICM402	3-PHASE LINE MONITOR	190-600 VAC	50/60 Hz	115 OR 230/240 VAC	SPST N.O. 30A	83.94

ICM 3-Phase Monitor ICM455



The ICM455 is a fully programmable 3-phase line voltage monitor with a backlit LCD, 50+ fault memory, and a real-time clock for accurate date and time stamp, 190-630 VAC (Control: 18-240 VAC).

Features:

- User Adjustable Settings:
- Voltage: 190-630 VAC
- Frequency: 50-60 Hz
- Voltage Unbalance: Adjustable: 2-20%
- Fault Interrogation: Adjustable: 0-15 seconds
- Over/Under Voltage: Adjustable: 2-25%
- Reset Modes: AUTO or 0-10 retries
- Control Mode: ON or OFF
- Control: 18-240 VAC
- Delay on Break Timer: 0-10 minutes
- Output: Relay SPDT
- - N.O.: 10 amps
- - N.C.: 6 amps

SOURCE 1 PART NO.	DESCRIPTION	INPUT		CONTROL VOLTAGE	OUTPUTS	MLP \$
		VOLTAGE	FREQUENCY			
S1-ICM455	3-PHASE LINE MONITOR	190-630 VAC	50/60 Hz	18-240 VAC	SPDT N.O. 10A, N.C. 6A	83.94

ICM 3-Phase Loss & Reversal Protection



Features:

- Reliable 3-phase protection for single side
- Monitors for phase reversal, phase loss, unbalance percentage as a function of input voltage
- Bright LED indicators for On and Fault
- Highly reliable passive electronics
- Phase reversal detection on power up

Specifications:

High Voltage Cut-Out Setpoint: +12%

Low Voltage Cut-Out Setpoint: -12%

Power/Phase Loss Detection: Within 100 ms

User Selectable Unbalance Voltage: 2%–8%

Voltage: 190–480 VAC

Frequency: 50–60 Hz

Adjustable Delay on Break: 1–5 min.

Relay Output: N.O./N.C. contacts: 10A resistive @ 250 VAC

SOURCE 1 PART NO.	MOUNT	DELAY ON MAKE	MLP \$
S1-ICM408	8-PIN PLUG-IN	1-5 MIN.	153.40
S1-ICM409	DIN RAIL	HEAVY-DUTY SPDT	225.82

LINE MONITORS

ICM 3-Phase Voltage Monitor-Programmable ICM450



Stop Motor Burnouts!

3-Phase line voltage monitor with 25-fault memory, hightemperature LCD display, easy setup & clear diagnostic display of system faults, 190-630 VAC operation...

The ICM450 was specifically designed to protect motors and other 3-phase loads from premature failure and damage due to common voltage faults such as voltage unbalance, over/under voltage, phase loss, reversal, incorrect sequencing and rapid short cycling.

Features:

- Reliable, high temperature LCD display simplifies system setup and diagnostics. Indicates condition of incoming line voltage, fault conditions, system setpoints and other user adjustments. Temp.: -20° to +75°C (-4° to +167°F)
- Simultaneous voltage display...an ICM exclusive!
- View all 3 phases, no need to scroll through readouts.
- Fully adjustable variables...user may easily set and adjust variables when in SETUP mode:
- Line voltage: 190-600 VAC
- Voltage unbalance: 2-20%
- Delay on break period: 0-10 min.
- Fault interrogation: 0-15 sec.
- Over/under voltage: 2-25%
- Reset modes: AUTO or 0-10 Retries
- Control modes: ON or OFF

Specifications:

Input

- Line voltage: universal- 190-630 VAC
- Frequency: 50/60 Hz

Output

- Type: relay, SPDT
- Voltage range: Up to 240 VAC (Max: 10 amps)
- Frequency: 50/60 Hz

Control Operating Temperature

- Operating temperature: -40° to +75°C, -40° to 167°F
- Storage temperature: -40° to +85°C, -40° to 185°F

LCD Operating Temperature

Operating temperature: -20° to +75°C, -4° to 167°F

Phase Unbalance Protection

Voltage unbalance: 2-20% adjustable

Over/under protection

- Under voltage: 2-25% adjustable
- Over voltage: 2-25% adjustable

Phase Loss Protection

- Phase loss condition= <25% of nominal for any given phase.
- System will shut down and a fault will be recorded should this condition occur.
- Delay on Break Timer
- Control voltage: 18-240 VAC
- Time delay: 0-10 min. adjustable

Fault Interrogation Delay

- Time delay: 0-15 sec. adjustable
- Provides a delay between fault detection & system shut-down - eliminating nuisance trips/unnecessary Shutdowns.

Mechanical

- Mounting: surface mount using (2) #8 screws
- Termination: screw terminals
- Weight: 12 ounces (341 grams)
- Easy to install and configure...wiring diagram on unit, simple
- 7-step push-button setup, guide included.
- 25-Fault memory and storage...clearly displayed in LCD
- Ultra bright LED indicators...shows current mode:

Setup LED

Load energized LED

Control voltage LED

Fault LED

Dimensions: 6.5" x 4.25" x 1.4"

Exclusive ICM Features

1. View all 3 voltages at once.
2. Front and back side fault identification.
3. Independent over/under voltage % adjustment.
4. ICM450 wiring diagram printed right on cover.
5. High-temperature LCD: -20° to +75°C, -4° to 167°F.
6. Line voltage programmable - (no step-up transformer needed).

SOURCE 1 PART NO.	ICM PART NO.	REPLACES	MLP \$
S1-ICM450	ICM450	S1-52531424000	347.00

Spanish-Language Model

SOURCE 1 PART NO.	ICM PART NO.	REPLACES	MLP \$
S1-ICM450-S	ICM450S	A-1: EAC-800, EAC-8000, EAC-8002 COPELAND: 085-0160-00 DIVERSIFIED: AC-2020, AC-301, AC-302 MOTORS AVER: 455 SSAC: QLM, QLV TIMEMARK: 265 WAGNER/Diversitech: DPT-3, WPC-800	406.23

LINE MONITORS

ICM Relay Sockets



Features:

- For use with ICM408, ICM410-427, and ICM500-505
- Relay socket
- 8-pin octal plug-in base
- Locating key ensures proper orientation
- Order ACS-11 for 11-pin base
- 10 amps up to 480 VAC

SOURCE 1 PART NO.	MOUNT	MLP \$
S1-ACS-11	ICM RELAY SOCKETS	18.80
S1-ACS-8	ICM RELAY SOCKETS	18.80

ICM Single Phase Line Monitors Series 491



High/low voltage protection for single phase systems, 95-270 VAC operation, adjustable anti-short cycle timer, ultra low cost...

The Series 490 was specifically designed guard equipment against damage caused under/over voltage and rapid system recycling.

Low cost single phase equipment protection

Protects against:

- Over/under voltage conditions
- Rapid system recycling

LED Indication (continuous under normal conditions)

Heavy Duty SPDT 8 amp Relay Output (isolated contacts)

Interrogation Delay helps prevent nuisance tripping

Integral, adjustable anti-short cycle protection

Mode of Operation

Upon application of power to the monitor, and provided all voltages are acceptable, the LED indicator light will glow, indicating that the output contacts have transferred.



Should a voltage unbalance or high/low voltage condition exist for longer than the 5 sec. interrogation delay, the relay and LED shall be deenergized. Re-energization is automatic upon correction of the fault condition and after the anti-short cycle time delay period is complete. Should a fault condition exist upon application of power, the output relay will not energize. Adjustment: Select the proper operating line voltage. Apply power. If the relay fails to energize, check wiring. Adjust lockout time delay to desired setting. Each unit is shipped with a detailed Installation guide.

Specifications:

Input

- Line voltage: 95-270 VAC
- Control voltage: 18-240 VAC/VDC
- Line frequency: 50 or 60 Hz

Output

- Type: relay energized upon acceptable line conditions
- Form: single pole double throw (SPDT)
- Ratings: n.o.-5 amps, n.c.-5 amps

Undervoltage Protection

- Voltage dropout: -12.5%
- Voltage pickup: -7.5%

Overvoltage Protection

- Voltage dropout: +12.5%
- Voltage pickup: +7.5%

Environmental

- Operating temperature: -40° to +75°C, -40° to +176°F
- Transient protection: meets IEEE 587 standards for categories A & B without false output or degradation
- (6Kv 0.5 μs x 100 KHz ring wave)(6Kv 1.2 x 50 ms impulse wave)

Dimensions: 3.25" x 3" x 1.25"

Mechanical

- Mounting: surface mount using (4) #8 screws
- Terminations: .25" male quick-connect terminals

Response Times

- Line dropout: .05 sec. (typical)
- Control voltage dropout: .07 sec. (typical)
- Line voltage sag (20%): .5 sec (typical)
- Turn-on: 5 sec. (typical)

Lockout Delay Timer Time delay: adj. 6-600 sec. (+/- 20%)

SOURCE 1 PART NO.	REPLACES	MLP \$
S1-ICM491	A-1: EAC-401, 402, 403, 404 DIVERSIFIED: CV-100-RS, CV-200-RS15, CV-200-RS20 MARS: 32522, 32524, 32526 WAGNER/Diversitech: DSP-1	92.10

LINE MONITORS

ICM Single Phase Digital Line Monitors Series 492



Features:

- Protects Against Over and Under Voltage, and Rapid Short Cycling caused by Transient Faults and Power Interruptions
- Easy-view, Backlit Digital Display
- RMS Voltage Monitoring
- Adjustable Voltage Set Point
- Adjustable Over Voltage Setting
- Adjustable Under Voltage Setting

Specifications:

User Adjustable Settings:

- Voltage set point: 95-280V
- Anti-short cycle time delay: 0-720 seconds
- Over voltage setting: 5-25%
- Under voltage setting: 5-25%
- Control mode: On and Off
- Response time: 0.1 to 10 seconds

Inputs:

- Line Voltage: 80 to 300 VAC
- Frequency: 50/60 Hz
- Accuracy: $\pm 2\%$
- Low Power Consumption: max 50 mA @ 120V, max 100 mA @ 240V
- Control Voltage: 24 to 240 VAC

- Adjustable Anti-Short Cycle Time Delay
- Adjustable Response Time
- Control Mode
- 5-Fault Memory
- Universal Line voltage Input
- Heavy Duty SPDT Relay Output
- Universal Control Voltage Input (for integrating a thermostat)

Output:

- Type: dry relay contacts
- Form: SPDT
- Relay Contact Ratings:
 - N.C. Contacts: 10A resistive @ 277 VAC
 - N.O. Contacts: 10A resistive @ 277 VAC
- Connection Terminals: 0.25" male fast-on

Mechanical:

- Case Dimensions: 3"L x 3.2"W x 1.35"H
- Unit Weight: 0.36 lbs.

Environmental:

- Operating temperature range: -30°C to +70°C
- Storage temperature range: -40°C to +85°C
- Max. Oper./Storage Relative Humidity: 95% noncondensing

SOURCE 1 PART NO.	DESCRIPTION	MLP \$
S1-ICM492	SINGLE PHASE, DIGITAL LINE VOLTAGE MONITOR	143.52

ICM431 3-Phase Voltage Monitor



Three-phase line voltage monitor offering protection against phase loss/reversal, and unbalance; 50/60 Hz, 190-600 VAC (18-30 control VAC) - 8-pin plug in mount (base sold separately)

Specifications:

- Voltage:** 190-600 VAC
- Frequency:** 50/60 Hz
- Control:** 18-30 VAC

Output:

- Relay, SPST
- N.O. 10 amps

SOURCE 1 PART NO.	DESCRIPTION	MLP \$
S1-ICM431	3-PHASE VOLTAGE MONITOR, PLUG IN MOUNT	110.09

ICM465 3-Phase Voltage Monitor



Three-phase line voltage monitor offering protection against phase loss/reversal, and unbalance; 50/60 Hz, 190-600 VAC (115 or 208/240 control VAC) - DIN rail mount

Specifications:

- Voltage:** 190-600 VAC
- Frequency:** 50/60 Hz
- Control:** 115 and 208/240 VAC

Output:

- Relay, SPST
- N.O. 10 amps

SOURCE 1 PART NO.	DESCRIPTION	MLP \$
S1-ICM462	3-PHASE VOLTAGE MONITOR, DIN RAIL MOUNT	122.10

HVAC Components

LINE MONITORS

ICM Single-Phase Line Voltage Monitor

ICM493



The ICM493 is an advanced, single-phase line voltage monitor with a bank of surge arresters for added protection against lightning strikes. Includes a built-in 40A contactor. Ideal for Mini-Splits or other valuable, single-phase equipment.

SOURCE 1 PART NO.	DESCRIPTION	MLP \$
S1-ICM493	PHASE MONITOR, SINGLE PHASE W/SURGE PROT	653.44

ICM Single-Phase Line Surge Protective Device

ICM517



ICM 517 Single Phase Surge Protective Device with metal, NEMA Type 3r Rated enclosure. 100,000 amp 1,020 joules of protection. UL Listed. Backed by a Limited Lifetime Protection Warranty.

Specifications:

Service Voltage: 120/240 volt, single phase
 Maximum Surge Current: 100,000 Amps
 Maximum Energy Dissipation: 1,020 Joules
 Installation Point:
 - Electrical Panel

- Service Disconnect

AC Protection Modes: L-L, L-N, L-G, N-G
 Conduit Connection: 3/4"
 Dimensions: 5"L x 2.78"W x 2.16"D
 Weight: 0.55 lbs.

SOURCE 1 PART NO.	DESCRIPTION	MLP \$
S1-ICM517	SURGE PROTECTOR, 120/240VAC, 100KA, 840J	149.10

TRANSFORMERS

Honeywell Standard Transformer



24V control circuit step-down transformer designed to power any 24V control system, including thermostats, gas valves and relays.

Features:

- Energy limiting, meets NEMA Standard DC20-1992. Transformer is marked "NEMA Type D."
- Meets "NEC Class 2 not wet, Class 3 wet" and U.L. 1585 requirements.
- Mount within proper enclosure.

Specifications:

Electrical Connections (Primary): 9" (229 mm) lead wires.

Electrical Connections (Secondary): (2) screw terminals.

Mounting: can be foot-mounted; plate-mounted on 4"x4", 4" octagon, or 2"x4" electrical boxes (transformer all above plate or 3/4 above plate); or clamp-mounted via a junction box knockout.

Approvals: UL Component Recognized. CS Certified, N.E.C. Approved.

SOURCE 1 PART NO	ELECTRICAL RATINGS				DIMENSIONS	TEMPERATURE RATINGS	MLP
	PRIMARY VOLTAGE	FREQ (HZ)	OUTPUT	SEC VOLT			
S1-AT72D1683	120 V	50/60	24 V AT 40 VA	26.5 V.O.C.	3-7/32" H X 2-7/32" W X 3-1/16" D (81.8 MM H X 56.4 MM W X 77.8 MM D)	-20°F TO +105°F -29°C TO +41°C	65.57

HVAC Components

TRANSFORMERS

Source 1 Class 2 Transformers - 90-T40S1 thru 90-T75C3 24 Volt Secondary Class 2 Energy Limiting

Air conditioning, heating and refrigeration replacements.

Foot mounted-4" x 4" plate-conduit hub.

Source 1 multi-mounting control transformers are designed especially for the air conditioning market. The 24 volt output of the transformer assures the operation of valves, relays and contactors under most low voltage conditions, eliminating call backs due to brown outs.

Class 2 transformers are used for industrial, heating and air conditioning controls applications.

Foot-Mount (Open Construction)



SOURCE 1 PART NO.	MARS PART NO.	JARD PART NO.	VA	HZ	PRIMARY	SEC.	CONN	MLP \$
S1-T2404F	50354	4031F	40	60	120/208/240V	24V	LEADS	21.23

*Manual reset

Multi-Mount (Closed Construction) Universal Mounting With Plate



SOURCE 1 PART NO.	MARS PART NO.	JARD PART NO.	VA	HZ	PRIMARY	SEC.	CONN	MLP \$
S1-T3501M	50304	4031M	50		120/208/240V	24V	LEADS	26.24
S1-T6753	50314	5031M	75	50/60	120/208/240/480V	24V	LEADS	42.28
S1-T7752			75	50/60	120/208/240/480V	24V		44.04

Source 1 Transformer Lead Color Coding

PRIMARY SIDE				SECONDARY SIDE	
COMMON	120V	208V	240V	COMMON	24V
WHITE	BLACK	RED	ORANGE	YELLOW	YELLOW

White Rodgers Transformers



SOURCE 1 PART NO.	DESCRIPTION	VA	Hz	PRIMARY	CONN.	SEC.	MLP \$
S1-90-T50C3	FOOT-MOUNT (MANUAL RESET, OPEN CONSTRUCTION): 90-T50C3	50	50/60	120/208/240V	LEADS	24V	76.76
S1-90-T60C3	FOOT-MOUNT (MANUAL RESET, OPEN CONSTRUCTION): 90-T60C3	60	50/60	120/208/240V	LEADS	24V	88.89
S1-90-T75C3	FOOT-MOUNT (MANUAL RESET, OPEN CONSTRUCTION): 90-T75C3	75	50/60	120/208/240V	LEADS	24V	114.20

RESIDENTIAL AIR FILTRATION SYSTEMS

SOURCE 1 Electronic Air Cleaners



The S1-TEAC1625 and S1-TEAC2025 Electronic Air Cleaners use a high-voltage ionizer within the air cleaner that electrically charges airborne pollutants and particles. It also features electrostatic precipitators - a series of metal collection plates that are oppositely charged to the ionized particles. The negative filter plate attracts and captures these microscopic particles, preventing them from being recirculated in the home. Lastly, these electronic air cleaners offer high performance and efficiency, ultra-quiet operation and no filters to replace.

Features:

- The strongest, most reliable power supply and the sturdiest cell in the industry (recognized by dealers nationwide).
- Forever Filter® never needs replacing – just clean and reuse.
- Connects directly to all types of heating and cooling systems.
- Permanent, washable aluminum collection cells deliver longer service life and are easy to clean.
- Greater overall HVAC system efficiency because units keep cooling coils clean.
- Electronic Airflow Sensor: Automatically senses air movement within the duct, resulting in reduced power usage.
- Built-In Internal Fuse: Protects the 24v transformer in the event of a power supply failure.
- All units are UL/C-UL Listed and are easily converted to 240v.
- Rugged cabinet construction for long life.
- Optional Charcoal After-Filter reduces common household odors.



SOURCE 1 PART NO.	DESCRIPTION	BRAND	MLP \$
S1-TEAC1625	AIR CLEANER,ELECTR,STD,1400 CFM,16X25	SOURCE 1, YORK, COLEMAN, LUXAIRE, CHAMPION	1151.47
S1-TEAC2025	AIR CLEANER,ELECTR,STD,2000 CFM, 20X25	SOURCE 1, YORK, COLEMAN, LUXAIRE, CHAMPION	1189.87

Premium Hybrid Media/Electronic Air Cleaners



Features:

- Whole home electronic air cleaner utilizes both the electrostatic attraction and filter media to provide a more consistent, higher level of performance.
- Equivalent to MERV16 efficiency
- System matching appearance
- When new:
 - 97.8% effective at removing particles from 3-10 microns
 - 95.7% effective at removing particles from 1-3 microns
 - 92.0% effective at removing particles from 0.3-1.0 microns
- Rated to 2000CFM
- Support up to 400 lbs
- Low airflow resistance:
 - 0.10" w.g. @1000 cfm
 - 0.29" w.g. @ 2000 cfm
- Easy maintenance:
 - Replace filter media once per year.
 - No washing of cells required; only wiping down of ionizing wires
- Power usage does not exceed 60 watts
- UL Listed
- Silent operation; no snapping from the electronic charge of particles

SOURCE 1 PART NO.	BRAND	MLP \$
S1-HEAC3000T	SOURCE 1, YORK, COLEMAN, LUXAIRE, CHAMPION	1613.76

Replacement Media

SOURCE 1 PART NO.	DESCRIPTION	MLP \$
S1-FM501	HEAC3000 ELECT-HYBRID MEDIA	73.21

VENTILATION & INDOOR AIR QUALITY

RESIDENTIAL AIR FILTRATION SYSTEMS

SOURCE 1 High Efficiency Right Angle Media Air Cleaners



The Right Angle Air Cleaner uses a combination of four filtering principles including impingement, interception, diffusion and straining. Its high performance, non-woven, reinforced media captures a wide range of airborne particulate matter. Most pleated air filters capture pollutants primarily by surface loading. This can restrict airflow through your comfort system and result in higher heating and cooling costs. The S1-TRAC2000 grasps contaminants much like a sponge. Its radial pleating and state of the art fiber design provides maximum dust holding capacity.

Features:

- Quick and Easy Installation.
- Filters capture and hold pollutants inside the filter, allowing air to freely through the system.
- High efficiency MERV 11 filter, electrostatically-charged synthetic material, provides superior efficiency with minimal added pressure drop.
- Designed for installations that require a 90° duct adapter.
- Mounts directly to heating and cooling systems.
- Suitable for use with all types of central forced-air configurations.
- Space saving design is ideal for basement applications.
- Rugged cabinet construction for long life.
- Rated Airflow of up to 2000 CFM.
- Tested in accordance with ANSI/ASHRAE 52.2-2007
- Efficiency rating of MERV 11.
- Recommended Media Replacement: S1-KF-102-718-201

SOURCE 1 PART NO.	DESCRIPTION	BRAND	MLP \$
S1-TRAC2000	AIR CLEANER, MEDIA, RIGHT ANGLE, MERV 11	SOURCE 1, YORK, COLEMAN, LUXAIRE, CHAMPION	362.82

Replacement Media

SOURCE 1 PART NO.	DESCRIPTION	MLP \$
S1-KF-102-718-201	FILTER, REPLACEMENT, MERV11, 20X25X5 (M3)	59.85

SOURCE 1 High Efficiency Expandable Media Air Cleaners



Features:

- The whole home media air cleaner permanently traps particles, including airborne contaminants, down to 1 micron (1 millionth of a meter) in size. Particles of less than 6 microns are invisible to the naked eye, and allergy-causing particles and mold spores range from 0.5 microns to 1 micron.
- Helps minimize the risk of asthma and allergy attacks
- Up to 2 year filter media life
- Low static pressure drop
- MERV 10 or MERV 13 efficiency rating
- 5-year limited warranty

SOURCE 1 PART NO.	DESCRIPTION	BRAND	MLP \$
S1-TM11PAC16252	16" x 25" WHOLE HOME EXPANDABLE MEDIA AIR CLEANER	SOURCE 1, YORK, COLEMAN, LUXAIRE, CHAMPION	243.89
S1-TM11PAC20202	20" x 20" WHOLE HOME EXPANDABLE MEDIA AIR CLEANER	SOURCE 1, YORK, COLEMAN, LUXAIRE, CHAMPION	248.67
S1-TM11PAC20252	20" x 25" WHOLE HOME EXPANDABLE MEDIA AIR CLEANER	SOURCE 1, YORK, COLEMAN, LUXAIRE, CHAMPION	243.89
S1-TM13PAC16252	16" x 25" WHOLE HOME EXPANDABLE MEDIA AIR CLEANER	SOURCE 1, YORK, COLEMAN, LUXAIRE, CHAMPION	313.66
S1-TM13PAC20202	20" x 20" WHOLE HOME EXPANDABLE MEDIA AIR CLEANER	SOURCE 1, YORK, COLEMAN, LUXAIRE, CHAMPION	313.66
S1-TM13PAC20252	20" x 25" WHOLE HOME EXPANDABLE MEDIA AIR CLEANER	SOURCE 1, YORK, COLEMAN, LUXAIRE, CHAMPION	313.66

Replacement Media for Expandable Media Air Cleaners

SOURCE 1 PART NO.	FOR MODEL NO	STD PKG	MASTER CARTON QTY	MLP \$
S1-FM11162506	S1-MAC11162506, AC24, APRILAIRE 2400	1	9	78.30
S1-FM11202506	S1-MAC11202506, AC22	1	9	78.30
S1-FM201	S1-WHM10202505, APRILAIRE 2200	1	10	57.33
S1-FM210	S1-TM11PAC20252, APRILAIRE 1210	1	8	81.01
S1-FM213	S1-TM13PAC20252, APRILAIRE 4200, 3210, 2210	1	8	96.17
S1-FM310	S1-TM11PAC20202, APRILAIRE 1310	1	8	75.95
S1-FM313	S1-TM13PAC20202, APRILAIRE 4300, 3310, 2310	1	8	92.89
S1-FM401	S1-WHM10162505, APRILAIRE 2400	1	10	54.73
S1-FM410	S1-TM11PAC16252, APRILAIRE 1410	1	8	75.95
S1-FM413	S1-TM13PAC16252, APRILAIRE 4400, 3310, 2410	1	8	91.11
S1-FM613	16 x 25 COMPETITORS' UNITS WITH S1-4897 ADAPTER KIT	1	8	95.93
S1-FM813	20 x 25 COMPETITORS' UNITS WITH S1-4897 ADAPTER KIT	1	8	95.93

Indoor Air Quality

RESIDENTIAL AIR FILTRATION SYSTEMS

SOURCE 1 High Efficiency Expandable Media Air Cleaners

Media Upgrade Kits for Source 1 and Competitors Air Cleaners

SOURCE 1 PART NO.	FOR MODEL NO	STD PKG	MASTER CARTON QTY	MLP \$
S1-FRKIT1213	CONVERTS S1-WHM10202506 AND APRILAIRE 2200 TO ACCEPT S1-FM213 MEDIA	1	6	125.29
S1-FRKIT1413	CONVERTS S1-WHM10162506 AND APRILAIRE 2400 TO ACCEPT S1-FM413 MEDIA	1	6	125.29
S1-FRKIT213	CONVERTS S1-*M*PAC2025 TO ACCEPT S1-FM210 OR S1-FM213 MEDIA	1	8	27.86
S1-FRKIT313	CONVERTS S1-*M*PAC2020 TO ACCEPT S1-FM310 OR S1-FM313 MEDIA	1	8	27.86
S1-FRKIT413	CONVERTS S1-*M*PAC1625 TO ACCEPT S1-FM410 OR S1-FM413 MEDIA	1	8	27.86
S1-FRKIT4897	CONVERTS COMPETITORS' UNITS TO ACCEPT S1-FM613 OR S1-FM813 MEDIA	1	8	27.86

MERV11 High Efficiency Media Air Cleaners

Replacement Cartridges for MAC10 Series MERV11 Media Air Cleaners

SOURCE 1 PART NO.	DESCRIPTION	SIZE (INCHES)	REPLACES	STD. PKG.	MLP \$
S1-KF-102-718-210	FILTER,REPLACEMENT,MERV11,AB,16X25X5	16X25X5	S1-FM10162505	3	51.55
S1-KF-102-718-203	FILTER,REPLACEMENT,MERV11,AB,20X20X5	20X20X5	S1-FM10202005	4	57.93
S1-KF-102-718-201	FILTER,REPLACEMENT,MERV11,AB,20X25X5	20X25X5	S1-FM10202505	3	59.85

Replacement Media For Honeywell Air Cleaners

SOURCE 1 PART NO.	DESCRIPTION	SIZE (INCHES)	REPLACES	STD. PKG.	MLP \$
S1-KF-102-718-205	FILTER,REPLACEMENT,MERV11,HW,16X25X4	16X25X4	HONEYWELL FC100A1029	3	48.01
S1-KF-102-718-206	FILTER,REPLACEMENT,MERV11,HW,20X20X4	20X20X4	HONEYWELL FC100A1011	4	49.40
S1-KF-102-718-204	FILTER,REPLACEMENT,MERV11,HW,20X25X5	20X25X4	HONEYWELL FC100A1037	3	51.51

HIGH EFFICIENCY MEDIA AIR CLEANERS

Koch Filters Replacement Media for Trion Airbear® and Air Cub®

SOURCE 1 PART NO.	DESCRIPTION	SIZE (INCHES)	STD. PKG.	MLP \$
S1-KF-102-718-001	FILTER,REPLACEMENT, MERV8	20X25X5	3	39.85
S1-KF-102-718-002	FILTER,REPLACEMENT, MERV8	16X25X3	6	39.71
S1-KF-102-718-003	FILTER,REPLACEMENT, MERV8	20X20X5	4	47.87
S1-KF-102-718-010	FILTER,REPLACEMENT, MERV8	16X25X5	3	44.04
S1-KF-102-718-201	FILTER,REPLACEMENT, MERV11	20X25X5	3	59.85
S1-KF-102-718-202	FILTER,REPLACEMENT, MERV11	16X25X3	6	41.52
S1-KF-102-718-203	FILTER,REPLACEMENT, MERV11	20X20X5	4	57.93
S1-KF-102-718-210	FILTER,REPLACEMENT, MERV11	16X25X5	3	51.55
S1-KF-102-718-301	FILTER,REPLACEMENT, MERV13	20X25X5	3	65.72
S1-KF-102-718-302	FILTER,REPLACEMENT, MERV13	16X25X3	6	47.76
S1-KF-102-718-303	FILTER,REPLACEMENT, MERV13	20X20X5	4	66.81
S1-KF-102-718-310	FILTER,REPLACEMENT, MERV13	16X25X5	3	57.42

Koch Filters Replacement Media for Honeywell® F-Series

SOURCE 1 PART NO.	DESCRIPTION	SIZE (INCHES)	STD. PKG.	MLP \$
S1-KF-102-718-004	FILTER,REPLACEMENT, MERV8	20X25X4	3	44.00
S1-KF-102-718-005	FILTER,REPLACEMENT, MERV8	16X25X4	3	42.98
S1-KF-102-718-006	FILTER,REPLACEMENT, MERV8	20X20X4	4	41.17
S1-KF-102-718-204	FILTER,REPLACEMENT, MERV11	20X25X4	3	51.51
S1-KF-102-718-205	FILTER,REPLACEMENT, MERV11	16X25X4	3	48.01
S1-KF-102-718-206	FILTER,REPLACEMENT, MERV11	20X20X4	4	49.40
S1-KF-102-718-304	FILTER,REPLACEMENT, MERV13	20X25X4	3	59.37
S1-KF-102-718-305	FILTER,REPLACEMENT, MERV13	16X25X4	3	59.49
S1-KF-102-718-306	FILTER,REPLACEMENT, MERV13	20X20X4	4	59.30

Indoor Air Quality

RESIDENTIAL AIR PURIFIERS

Premium UV Air Purifiers with Status Indicator LED

Replacement Lamps

SOURCE 1 PART NO.	DESCRIPTION	MLP \$
S1-LAPS120A	REPLACEMENT UV LAMP WITH POWER SUPPLY, 115V	200.80
S1-LAPS220A	REPLACEMENT UV LAMP WITH POWER SUPPLY, 230V	207.42

SOURCE 1 UV Air Purifiers

Replacement Ultra Violet "C" Lamps

SOURCE 1 PART NO.	FOR MODEL NO	STD PKG	MASTER CARTON QTY	MLP \$
S1-UVLAMP36120	S1-UV36120	1	10	169.07
S1-UVLAMP36120HW	S1-UV100A1083	1	N/A	145.87
S1-UVLAMP50120	S1-UV50120	1	10	202.02

RESIDENTIAL HUMIDIFIERS

Premium Bypass and Flow-Through Humidifiers

Bypass and Flow-Through



SOURCE 1 PART NO.	DESCRIPTION	BRAND	ELECTRICAL RATING	GPD	MLP \$
S1-BP4000MT	DRAINLESS BYPASS HUMIDIFIER W/MANUAL HUMIDISTAT	LUXAIRE, COLEMAN	24 VAC	17	383.95
S1-BP5000MT	BYPASS HUMIDIFIER WITH MANUAL H'STAT	LUXAIRE, COLEMAN	24 VAC	12	313.30
S1-BP6000MT	BYPASS HUMIDIFIER WITH MANUAL	LUXAIRE, COLEMAN	24 VAC	17	345.56
S1-FP7000MT	POWER HUMIDIFIER WITH MANUAL H'STAT	LUXAIRE, COLEMAN	120 VAC	18	538.78

Premium Humidifiers

Replacement Water Pads

SOURCE 1 PART NO.	DESCRIPTION	STD. PKG	MASTER CARTON QTY	MLP \$
S1-HUPAD10	VAPOR PAD FOR S1-BP5000	1	10	10.92
S1-HUPAD35	VAPOR PAD FOR S1-BP6000 & S1-FP7000	1	10	14.68
S1-HUPAD45	VAPOR PAD FOR S1-BP4000	1	10	41.39

Steam Humidifiers



Residential Steam Humidifier - For applications when evaporative units are less practical (attics, crawl spaces, closets, milder winter climates, non-forced air heating source).

SOURCE 1 PART NO.	DESCRIPTION	CAPACITY	ELECTRICAL DATA	DIMENSIONS	MLP \$
S1-STEAM8000T01	HUMIDIFIER, STEAM, RESIDENTIAL	11.5,20.5,23.5 GPD	120V, 208V, 24V-60HZ 11.5A	10.13" X 18.0" X 7.13"	2117.95

Steam Humidifier Replacement Cylinders & Accessory Options

SOURCE 1 PART NO.	DESCRIPTION	STD PKG	MLP \$
S1-HUCYL12	REPLACEMENT STEAM CYLINDERS FOR S1-HU12DS & S1-HU12RD	1	300.86
S1-HUCYL20	REPLACEMENT STEAM CYLINDER FOR S1-HU20DS	1	466.96
S1-HUCYL20LC	REPLACEMENT STEAM CYLINDER FOR S1-HU20DSL	1	466.96
S1-HUCYL6	REPLACEMENT STEAM CYLINDER FOR S1-HU6DS & S1-HU6RS	1	314.24

Indoor Air Quality

RESIDENTIAL DEHUMIDIFIERS

Central Dehumidifiers



Provide dedicated moisture removal more efficiently than your air conditioner. Installed as part of your home's heating and cooling system, a central dehumidifier pulls air from every room through the return ducts. Then it removes moisture and cycles dry air back throughout your home. Brand options include: SOURCE 1, YORK, COLEMAN, LUXAIRE, CHAMPION.

SOURCE 1 PART NO.	DESCRIPTION	CAPACITY	VENTILATION OPTION	DIMENSIONS	MLP \$
S1-CVD070T01	CENTRAL DEHUMIDIFIER, NO-VENT,65PTS/DAY	70 PINTS/DAY	YES	12.5"X14.5"X25"	2968.85
S1-CVD095T01	CENTRAL VENTILATING DEHUMIDIFIERS,95 PTS/DAY	95 PINTS/DAY	YES	12.5"X14.5"X27.5"	3526.22
S1-CVD130T01	CENTRAL VENTILATING DEHUMIDIFIERS,130 PTS/DAY	130 PINTS/DAY	YES	19.5"X18.75"X30"	4984.70

RECOVERY VENTILATORS

Source 1 Energy Recovery Ventilators



Includes: Labels for Source 1, York, Luxaire and Coleman brands.

Specifications:

Heat Exchanger Type: Cross-flow (enthalpic)

Defrost Type: Evacuation

Voltage: 120 VAC at 60 Hz

Certification: ARI 1060, cCSAusa

Amperage: 1.5 A

SOURCE 1 PART NO.	DEMENSIONS (INCHES)		CFM	EXCHANGER SURFACE (SQ. FT.)	STD PKG	PALLET QTY	MLP \$
	OVERALL	HEAT EXCHANGER					
S1-ERV160	23-7/8"L X 21-1/2"H X 11-3/8"W	12"L X 12"H X 10"W	30-160	85	1	12	2519.72
S1-ERV220	23-7/8"L x 21-1/2"H x 16-1/2"W	12"L x 12"H x 15"W	50-220	127	1	9	3186.99

Source 1 Heat Recovery Ventilators

Heat/Energy Recovery Ventilator Accessory



Includes: Labels for Source 1, York, Luxaire and Coleman brands.

Specifications:

Heat Exchanger Type: Cross-flow (enthalpic)

Voltage: 120 VAC at 60 Hz

Amperage: 1.5 A

Defrost Type: Evacuation

Certification: ARI 1060, cCSAusa

SOURCE 1 PART NO.	DEMENSIONS (INCHES)		CFM	EXCHANGER SURFACE (SQ. FT.)	STD PKG	PALLET QTY	MLP \$
	OVERALL	HEAT EXCHANGER					
S1-HRV160	23-7/8"L x 21-1/2"H x 11-3/8"W	12"L x 12"H x 10"W	30-160	104	1	12	1864.70
S1-HRV220	23-7/8"L x 21-1/2"H x 16-1/2"W	12"L x 12"H x 15"W	50-220	150	1	9	2158.39

Indoor Air Quality

SMOKE & GAS DETECTORS

System Sensor Innovair® Series Photoelectric Low-Flow Duct Smoke Detectors



Features:

- Photoelectric, integrated low-flow technology
- Air velocity rating from 100 ft./min. to 4000 ft./min. (0.5 m/sec. to 20.32 m/sec.)
- Plug-in sensor offers superb false alarm immunity
- Broad ranges for operating temperature (4°F to 158°F) and humidity (0% to 95% non-condensing)
- Increased wiring space with a newly added 3/4-inch
- One easy-access Test/Reset button and improved LED status
- Built-in short-circuit protection from operator wiring
- Field-selectable settings for configuring the detector
- Integrated Smoke Test Port (S1-DUCTSD ONLY)
- Backward compatibility with existing Innovair products, including remote accessories
- Versatile mounting options: square or rectangular configuration
- Patented sampling tube installs from front or back of the detector with no tools required
- Patented interconnect feature for multi-fan shutdown
- New high-contrast terminal designations
- errors
- Two DPDT Form-C relay contacts
- 24 VAC/DC or 120 VAC

SOURCE 1 PART NO.	DESCRIPTION	MLP \$
S1-DUCTSD	STANDARD 4-WIRE PHOTOELECTRIC DUCT SMOKE DETECTOR	274.85
S1-D4120	4-WIRE PHOTOELECTRIC LOW-FLOW DUCT SMOKE DETECTOR	283.70
S1-D4120W	4-WIRE PHOTOELECTRIC LOW-FLOW DUCT SMOKE DETECTOR WITH WATERPROOF ENCLOSURE	412.22

System Sensor Innovair® Series Photoelectric Duct Smoke Detectors

Photoelectric Duct Smoke Detector Accessories

SOURCE 1 PART NO.	DESCRIPTION	MLP \$
S1-AOS	MINI-ALERT ADD-ON STROBE (WHITE)	93.09
S1-APA151	REMOTE ANNUNCIATOR WITH PIEZO ALARM	62.11
S1-B210LP	B210LP PLUG-IN DETECTOR BASE	28.52
S1-D4P120	4-WIRE PHOTOELECTRIC POWER BOARD COMPONENT ONLY, 24 VAC/DC, 120 VAC	226.05
S1-D4S	4-WIRE PHOTOELECTRIC SENSOR COMPONENT ONLY	193.94
S1-DST1	METAL SAMPLING TUBE DUCT WIDTH UP TO 1 FT. (0.3 M)	10.67
S1-DST1.5	METAL SAMPLING TUBE DUCT WIDTHS 1 FT. TO 2 FT. (0.3 TO 0.6 M)	14.21
S1-DST10	METAL SAMPLING TUBE DUCT WIDTHS 8 FT. TO 12 FT. (2.4 TO 3.7 M)	52.54
S1-DST3	METAL SAMPLING TUBE DUCT WIDTHS 2 FT. TO 4 FT. (0.6 TO 1.2 M)	19.97
S1-DST5	METAL SAMPLING TUBE DUCT WIDTHS 4 FT. TO 8 FT. (1.2 TO 2.4 M)	25.43
S1-RA100Z	REMOTE ANNUNCIATOR ALARM LED	35.47
S1-RTS151	REMOTE TEST STATION	75.34
S1-RTS151KEY	REMOTE TEST STATION WITH KEY LOCK	109.72
S1-RTS2	MULTI-SIGNALING ACCESSORY	186.17
S1-RTS2-AOS	MULTI-SIGNALING ACCESSORY	287.55
S1-2D51	PHOTOELECTRIC SMOKE DETECTOR HEAD	108.79

SL-2000 Series Duct Smoke Detectors



Available in both Ionization & Photoelectric Versions

Features:

- Designed to maximize efficiency of installation and maintenance
- “No-Tools Required” system allows for front or rear loading and removal of sampling tubes
- “No-Tools Required” thumbscrews make cover removal a snap
- Patent pending “test port” allows for aerosol smoke testing without cover removal
- “Low-Flow Technology” SL-2000 is listed for velocities between 100–4,000 ft. per minute



SOURCE 1 PART NO.	VERSION	SPECIFICATIONS	APPLICATION	MLP \$
S1-SL-2000-N	IONIZATION	4-WIRE, UNIVERSAL VOLTAGE	HIGH TEMPERATURE	274.15
S1-SL-2000-P	PHOTOELECTRIC	4-WIRE, UNIVERSAL VOLTAGE	LOW-FLOW TECHNOLOGY	272.71

Accessories

SOURCE 1 PART NO.	DESCRIPTION	MLP \$
S1-STN-10.0	10.0' SAMPLING TUBE	33.74
S1-STN-2.5	2.5' SAMPLING TUBE	15.60
S1-STN-5.0	5.0' SAMPLING TUBE	18.76
S1-TG-2000	TEST GAS WITH TEST PORT NOZZLE FOR DUCT DETECTORS	96.10

Replacement Parts

SOURCE 1 PART NO.	DESCRIPTION	MLP \$
S1-55000-225	REPLACEMENT IONIZATION SMOKE DETECTOR HEAD FOR SL-2000-N	130.88
S1-55000-328	REPLACEMENT PHOTOELECTRIC SMOKE DETECTOR HEAD FOR SL-2000-P	139.22
S1-STN-XT	REPLACEMENT EXHAUST TUBE	2.76

Indoor Air Quality

SMOKE & GAS DETECTORS

SM-501 Series Duct Smoke Detectors



Available in both Ionization & Photoelectric Versions

Features:

- Compact design allows for installation in the tightest spots
- Trusted performance, rugged steel construction
- Specifically designed to link up to 30 detectors

SOURCE 1 PART NO.	DESCRIPTION	SPECIFICATIONS	MLP \$
S1-SM-501-N	IONIZATION	4-WIRE, UNIVERSAL VOLTAGE	294.82

Accessories

SOURCE 1 PART NO.	DESCRIPTION	MLP \$
S1-ST5-2.5	2.5' SAMPLING TUBE	15.60
S1-ST5-5.0	5.0' SAMPLING TUBE	18.76

MS Series Remote Accessories



Features:

- Made of attractive and durable stainless steel
- Provides visual and/or audible status notification
- Remote test/reset option available
- 15 versions available to meet your needs

SOURCE 1 PART NO.	DESCRIPTION	MLP \$
S1-MS-KA/P/R	REMOTE ALARM LED (RED), PILOT (GREEN) & KEY-OPERATED TEST/RESET SWITCH	90.66
S1-MS-KA/P/R/T	REMOTE TROUBLE LED (YELLOW), PILOT LED (GREEN) & KEY-OPERATED TEST/RESET SWITCH	120.32
S1-MS-KA/R	REMOTE ALARM LED (RED) & KEY-OPERATED TEST/RESET SWITCH	87.68
S1-MS-RA/P/R	REMOTE ALARM LED (RED), PILOT LED (GREEN) & PUSH BUTTON TEST/RESET SWITCH	37.49
S1-MS-RH/KA/P/A/T	REMOTE ALARM HORN, ALARM LED (RED), TROUBLE LED (YELLOW), PILOT LED (GREEN) & KEY-OPERATED TEST/RESET SWITCH	133.29
S1-MS-RH/KA/P/R	REMOTE ALARM HORN, ALARM LED (RED), PILOT LED (GREEN) & KEY-OPERATED TEST/RESET SWITCH	144.60
S1-MS-RH/P/A	REMOTE ALARM HORN, ALARM LED (RED) & PILOT LED (GREEN)	53.57

T-PB Series 24VAC Power Supplies



Features:

- 24VAC output switch with status LED
- 4.0A, 96VA (Class I) and 3.0A, 72VA (Class II) versions available
- 115VAC @ 5.0A convenience outlet located on the front panel

SOURCE 1 PART NO.	DESCRIPTION	MLP \$
S1-T-PB-202-0	POWER SUPPLY, 100VA, 24VAC @4.0A, CLASS 1 CHASSIS	185.73
S1-T-PB-202-1	POWER SUPPLY, 100VA, 24VAC @ 4.0A, CLASS 1 CHASSIS WITH ENCLOSURE	252.14

Indoor Air Quality

SMOKE & GAS DETECTORS

Honeywell C7232 Carbon Dioxide (CO₂) Sensor



The Carbon Dioxide (CO₂) Sensors and Controllers are stand-alone carbon dioxide (CO₂) sensors for use in determining ventilation necessity with HVAC controllers. The sensor measures the CO₂ concentration in the ventilated space. (These models are wall-mount only.) The sensors are used in ventilation and air conditioning systems to control the amount of fresh outdoor air supplied to maintain acceptable levels of CO₂ in the space.

Features:

- Models available with LCD that provides sensor readings and status information.
- Non-Dispersion-Infrared (NDIR) technology used to measure carbon dioxide gas.
- Gold-plated sensor provides long-term calibration stability.
- C7232 provides voltage or current output based on CO₂ levels.
- Models available with SPST relay output.
- Proportional plus Integral (P+I) control algorithm.
- Used for CO₂ based ventilation control (Demand Control Ventilation (DCV)).
- Automatic Background Calibration (ABC) algorithm based on long-term evaluation reduces required typical zero-drift check maintenance.
- Digital input with programmable delay time for occupancy function using a sensor, pushbutton, or switch.

Specifications:

Mounting: Wall

Display: Yes

Carbon Dioxide Range: 0 to 3000 ppm

Analog Output: 0/2 to 10 Vdc or 0/4 to 20mA w/ one relay output

Relay Output: One: Normally Open SPST

Accessories: 32002181-001: Zero Calibration Service

Accuracy: 5% full scale

Timing (response): 2 minutes

SOURCE 1 PART NO.	POWER SUPPLY (VOLT)	FREQUENCY (HZ)	CONTACT RATING	OPERATING TEMPERATURE RANGE	DIMENSIONS	MLP \$
S1-C7232A1008	24 VAC (+/- 20%)	50, 60	1 A @ 50 VAC/24 VDC	32°F TO 122°F (0°C TO 50°C)	5-1/16"H X 3-11/16"W X 2"D (128 MM H X 80 MM W X 25 MM D)	703.56
S1-C7232A1016	24 VAC (+/- 20%)	50, 60	1 A @ 50 VAC/24 VDC	32°F TO 122°F (0°C TO 50°C)	5-1/16"H X 3-5/32"W X 2"D (128 MM H X 80 MM W X 25 MM D)	683.76
S1-C7232B1014	24 VAC (+/- 20%)	50, 60	1 A @ 50 VAC/24 VDC	32°F TO 122°F (0°C TO 50°C)	5-5/8" H X 3-5/16" W X 3 7/16" D X plus 8" long sensing tube (142 MM H X 84 MM W X 87 MM D X plus 203 MM sensing tube)	875.01

Zoning, Venting & Economizer Controls

CONTROL PANELS

SOURCE 1 Four-Zone Expandable Control Panels



Zone System, Model S1-MZS4

Controls various types of HVAC Equipment all from the same panel. The S1-MZS4 features single stage thermostats to control up to three stage heating and two stages cooling and simple heat pump thermostats to control heat pumps. The S1-MZS4 has various features that make installation and checkout very simple for all of the board's functionality. The S1-MZS4 panel is made of sturdy ABS plastic and can be mounted to any flat surface. Wall or return plenum and NOT on the furnace or plenum. The panel can be located in an attic space or in an enclosed cabinet of a rooftop unit. Features Continuous Air Circulation (CAC) in those zones where the thermostat's Fan Switch is set to ON. The S1-MZS4 is factory set for conventional fossil fuel (oil or gas) single and up to three stage heating and two stage cooling. The panel only needs to be configured when using with an conventional electric furnace or hydro-air system in order to bring the fan on with a call for heat, or when using with a heat pump equipment and thermostats.

Features:

- Color coded push-in wiring blocks
- LED indicator lights for system operation, Individual zone indicating lights
- Single stage, two stage, and heat pump compatible
- Expandable to any number of Zones, Uses any four-wire thermostat
- Leaving air sensor for capacity protection
- Staging by time or by number of zones calling, Intelligent changeover timing

SOURCE 1 PART NO.	DESCRIPTION	ZONES	STAGES	VOLTAGE	MLP \$
S1-MZS4	ZONING CONTROL PANEL	4	2H/2C	24	760.88
S1-MZSK	ZONING CONTROL PANEL KIT	4	2H/2C	24	849.18

VENTILATION & INDOOR AIR QUALITY

Zoning, Venting & Economizer Controls

CONTROL PANELS

SOURCE 1 Three-Zone Single Stage Control Panels



The S1-MMZ3 Zoning Panel is a 2 and 3 zone, single stage heating and cooling control panel.

Features:

- Economy two and three zone control panel
- LED indicator lights for system operation
- Individual zone indicating lights
- Heating only or cooling only
- Single stage heating and cooling

Panel Specifications:

- Construction: ABS plastic
- Number of Zones: 2 and 3 Zones, Single Stage Heating and Cooling
- Dimensions: 7-5/8" x 7-1/4" x 1-3/8"
- Voltage: 24 VAC, 50/60 Hz
- Temperature Rating: 0°F to 120°F Operating, -20°F to 140°F
- Storage
- Humidity: 5% to 95% Non-Condensing
- Connection: Screwless push-in terminal Blocks

SOURCE 1 PART NO.	DESCRIPTION	ZONES	STAGES	VOLTAGE	MLP \$
S1-MMZ3	ZONING CONTROL PANEL	3	SINGLE	24	282.16
S1-MMZK	ZONING CONTROL PANEL KIT	3	SINGLE	24	368.56

NOTE: S1-MMZK INCLUDES S1-MMZ3 PLUS S1-ZMS LEAVING AIR SENSOR AND 24V TRANSFORMER

SOURCE 1 Two-Zone Add-On Module



A two-zone expansion panel used to add zones onto an S1-MZS4 Zone Control Panel.

Features:

- Two Zone Expansion Panel
- Modular Jacks for Easy Add-On Connection
- Color-Coded Screwless Terminal Blocks
- Individual Zone Indicating Lights
- Indicator LEDs for System Operation
- Expand Systems up to 10 Zones

Panel Specifications

- Construction:** ABS plastic
- Number of Zones:** 2 Expansion
- Dimensions:** 7-5/8" x 7-1/4" x 1-3/8"
- Voltage:** 24 VAC, 50/60 Hz
- Temperature Rating:** 0°F to 120°F Operating, -20°F to 140°F Storage
- Humidity:** 5% to 95% Non-Condensing
- Connection:** Screwless push-in terminal Blocks

SOURCE 1 PART NO.	DESCRIPTION	ZONES	STAGES	VOLTAGE	MLP \$
S1-MZA2	ADD-ON ZONING MODULE	2	-	-	579.30

SOURCE 1 Three-Zone Multi-Stage Control Panels



Features:

- Color-Coded Push-In Wiring Blocks
- Uses Any Four Wire Thermostat
- Three Stage Heating, Two Stage Cooling & Heat Pumps
- Two and Three Zone Panel
- Leaving Air Sensor for Capacity Protection
- Intelligent Changeover Timing
- Indicator Lights for System Operation

Panel Specifications:

- Construction:** ABS plastic
- Number of Zones:** 2 and 3 Zones, Single Stage Heating and Cooling
- Dimensions:** 7-5/8" x 7-1/4" x 1-3/8"
- Voltage:** 24 VAC, 50/60 Hz
- Temperature Rating:** 0°F to 120°F Operating, -20°F to 140°F
- Storage Humidity:** 5% to 95% Non-Condensing
- Connection:** Screw less push-in terminal Block

SOURCE 1 PART NO.	DESCRIPTION	ZONES	STAGES	VOLTAGE	MLP \$
S1-MMH3	ZONING CONTROL PANEL	3	2H/1C	24	320.43
S1-MMHK	ZONING CONTROL PANEL KIT	3	2H/1C	24	409.51

NOTE: S1-MMHK INCLUDES S1-MMH3 PLUS S1-ZMS LEAVING AIR SENSOR AND 24V TRANSFORMER

ZONING ACCESSORIES & DAMPERS

SOURCE 1 Zoning Accessories



Static Pressure Switch Model S1-SPS

The Static Pressure Switch is used to sense the supply air duct's static pressure and control the modulating by-pass damper (Models S1-ZDM or S1-RDM) in order to maintain the duct system air pressure. When used on a zone control system, the supply air static pressure increases as various zone dampers close down. The increase in static pressure can become noisy and reduce the volume of air through the HVAC Unit, if the static overcomes the rating of the blower.

By-Pass Control Operation

Above 0.3" W.C. - Damper Opens
 Between 0.2" W.C. and 0.3" W.C. - Damper Stops
 Below 0.2" W.C. - Damper Closes
 The S1-SPS design incorporates two pressure sensitive diaphragms and two single pole single throw snap action electrical switches.

Electrical Ratings:

SPST Snap Acting Electronic Switches
 28VA Pilot Duty @ 24VAC
 125VA @ 125VAC
 SPST Electrical Load
 3 A Resistive @ 120VA

SOURCE 1 PART NO.	DESCRIPTION	MLP \$
S1-SPC	STATIC PRESSURE ZONING CONTROL	462.96
S1-SPS	STATIC PRESSURE ZONING SWITCH	143.27
S1-ZMS	DISCHARGE AIR ZONING SENSOR	65.12

Zoning, Venting & Economizer Controls

ZONING ACCESSORIES & DAMPERS

SOURCE 1 Outside Air Sensor



Senses outdoor air temperature when controlling dual fuel/fossil fuel heat pumps.

SOURCE 1 PART NO.	DESCRIPTION	MLP \$
S1-OAS	SENSOR,AIR,OUTDOOR	52.03

SOURCE 1 Modulating Round Zoning Dampers



The S1-RDM can be used for zone control or as the motorized damper for by-pass air when controlled by the Static Pressure Switch, Model S1-SPS. It is designed to also handle high pressure air conditioning systems up to 4" S.P. The motor actuator delivers up to 18 in/lbs of torque that powers the S1-RDM open and closed. This powerful motor allows the damper to handle higher static pressures and can be modulated using the SPS Static Pressure Switch or similar type control.

Features:

- 3-wire, power open and close
- LED damper position indicators
- Neoprene gasket seal
- 24 VAC

Damper Specifications:

Construction: 22 Ga. Galvanized Steel

Linkage: Direct Drive

Motor Voltage: 24 VAC, 50/60 Hz, 6.5 Watts, 7VA

Torque: 35 in-lbs.

Temperature Rating: -4°F to 140°F Operating, -20°F to 150°F Storage

Humidity: 5% to 95% Non-Condensing

Damper Timing: Nominal 30 Sec. Powered

Connection: Screw Terminals

Duct Pressure: Maximum 4.0" W.C.

SOURCE 1 PART NO.	SIZE (IN.)	MLP \$
S1-RDM05	5	262.23
S1-RDM06	6	272.75
S1-RDM07	7	274.59
S1-RDM08	8	278.15
S1-RDM09	9	282.32
S1-RDM10	10	285.44
S1-RDM12	12	290.48
S1-RDM14	14	307.63
S1-RDM16	16	321.94
S1-RDM18	18	340.44
S1-RDM20	20	360.32

NOTE: S1-RDM DAMPERS CAN BE USED AS MODULATING POWERED BYPASS DAMPERS WHEN APPLIED WITH S1-SPS STATIC PRESSURE ZONING SWITCH.

SOURCE 1 Retro-Round Zoning Dampers



A 24 Volt AC, power open, power closed damper. The damper is simply inserted into rigid metal branch ducts. The single blade is powered open and close to control the flow of air to each outlet. The S1-RRM damper blade has a wide wiper seal to seal against the inside of the ducts.

The S1-RDM can be used for zone control or as the motorized damper for by-pass air when controlled by the Static Pressure Switch, Model S1-SPS. It is designed to also handle high pressure air conditioning systems up to 4" S.P. The simple 3 wire motor has a Red motor release button that allows the damper blade to be manually rotated without harm to the motor. It also has LED position indicators that illuminate GREEN when Open and RED when Closed. The motor actuator delivers up to 18 in/lbs of torque that powers the S1-RRM open and closed. This powerful motor allows the damper to handle higher than normal static pressure, up to 3" W.C. Multiple dampers can be wired in parallel. Up to 12 dampers per 40VA transformer. When more than 12 dampers are required use a larger VA transformer. Each motor requires 3VA.

Features:

- Plug-and-play wiring
- Power open and close
- LED damper position indicators
- Rubber gasket seal
- 24 VAC
- Temperature Rating: -4°F to 140°F Operating, -20°F to 150°F Storage

SOURCE 1 PART NO.	SIZE	MLP \$
S1-RRM04	4	249.05
S1-RRM05	5	249.05
S1-RRM06	6	254.46
S1-RRM07	7	254.46
S1-RRM08	8	255.63

Zoning, Venting & Economizer Controls

ZONING DAMPERS

SOURCE 1 Rectangular Zoning Dampers

Bottom Mount



SOURCE 1 PART NO.	SIZE (IN.)	MLP \$
S1-ZDMB0810	8 x 10	350.27
S1-ZDMB0812	8 x 12	356.05
S1-ZDMB0814	8 x 14	379.37
S1-ZDMB0816	8 x 16	385.34
S1-ZDMB0818	8 x 18	391.18
S1-ZDMB0820	8 x 20	398.90
S1-ZDMB0822	8 x 22	386.89
S1-ZDMB0824	8 x 24	393.79
S1-ZDMB0826	8 x 26	386.89
S1-ZDMB0828	8 x 28	409.43
S1-ZDMB0830	8 x 30	434.42
S1-ZDMB0832	8 x 32	421.28
S1-ZDMB0834	8 x 34	427.17
S1-ZDMB0836	8 x 36	432.98
S1-ZDMB1012	10 x 12	381.74
S1-ZDMB1014	10 x 14	405.50
S1-ZDMB1016	10 x 16	413.29
S1-ZDMB1018	10 x 18	420.00
S1-ZDMB1020	10 x 20	426.97
S1-ZDMB1022	10 x 22	432.50
S1-ZDMB1024	10 x 24	422.71
S1-ZDMB1026	10 x 26	415.06
S1-ZDMB1028	10 x 28	463.00
S1-ZDMB1030	10 x 30	464.80
S1-ZDMB1032	10 x 32	463.22
S1-ZDMB1034	10 x 34	478.53
S1-ZDMB1036	10 x 36	500.64
S1-ZDMB1214	12 x 14	423.45
S1-ZDMB1216	12 x 16	431.44
S1-ZDMB1218	12 x 18	410.35
S1-ZDMB1220	12 x 20	449.57
S1-ZDMB1222	12 x 22	456.82
S1-ZDMB1224	12 x 24	429.63
S1-ZDMB1226	12 x 26	437.51
S1-ZDMB1228	12 x 28	439.01
S1-ZDMB1230	12 x 30	442.80
S1-ZDMB1232	12 x 32	484.08
S1-ZDMB1234	12 x 34	494.86
S1-ZDMB1236	12 x 36	517.02
S1-ZDMB1416	14 x 16	439.08
S1-ZDMB1418	14 x 18	447.07
S1-ZDMB1420	14 x 20	457.59
S1-ZDMB1422	14 x 22	432.72
S1-ZDMB1424	14 x 24	442.39
S1-ZDMB1426	14 x 26	450.83
S1-ZDMB1428	14 x 28	459.10
S1-ZDMB1430	14 x 30	466.89
S1-ZDMB1432	14 x 32	469.66
S1-ZDMB1434	14 x 34	477.50
S1-ZDMB1436	14 x 36	490.38
S1-ZDMB1618	16 x 18	432.64
S1-ZDMB1620	16 x 20	479.26

Zoning, Venting & Economizer Controls

ZONING DAMPERS

SOURCE 1 Rectangular Zoning Dampers

Bottom Mount (cont.)

SOURCE 1 PART NO.	SIZE (IN.)	MLP \$
S1-ZDMB1622	16 x 22	461.02
S1-ZDMB1624	16 x 24	483.63
S1-ZDMB1626	16 x 26	540.74
S1-ZDMB1628	16 x 28	528.96
S1-ZDMB1630	16 x 30	543.13
S1-ZDMB1632	16 x 32	554.43
S1-ZDMB1634	16 x 34	565.72
S1-ZDMB1636	16 x 36	579.96
S1-ZDMB1820	18 x 20	461.02
S1-ZDMB1822	18 x 22	489.27
S1-ZDMB1824	18 x 24	500.64
S1-ZDMB1826	18 x 26	528.96
S1-ZDMB1828	18 x 28	542.14
S1-ZDMB1830	18 x 30	579.96
S1-ZDMB1832	18 x 32	591.26
S1-ZDMB1834	18 x 34	608.26
S1-ZDMB1836	18 x 36	622.38
S1-ZDMB2022	20 x 22	514.77
S1-ZDMB2024	20 x 24	528.96
S1-ZDMB2026	20 x 26	557.30
S1-ZDMB2028	20 x 28	562.93
S1-ZDMB2030	20 x 30	594.13
S1-ZDMB2032	20 x 32	608.26
S1-ZDMB2034	20 x 34	625.22
S1-ZDMB2036	20 x 36	642.21
S1-ZDMB2224	22 x 24	560.13
S1-ZDMB2226	22 x 26	582.77
S1-ZDMB2228	22 x 28	588.43
S1-ZDMB2230	22 x 30	619.59
S1-ZDMB2232	22 x 32	642.21
S1-ZDMB2234	22 x 34	656.42
S1-ZDMB2236	22 x 36	676.25
S1-ZDMB2426	24 x 26	608.26
S1-ZDMB2428	24 x 28	613.96
S1-ZDMB2430	24 x 30	650.76
S1-ZDMB2432	24 x 32	667.75
S1-ZDMB2434	24 x 34	684.72
S1-ZDMB2436	24 x 36	703.95

Note: S1-ZDMB dampers can be used as modulating powered bypass dampers when applied with S1-SPS static pressure zoning switch.

SOURCE 1 Rectangular Zoning Dampers

Side Mount



SOURCE 1 PART NO.	SIZE (IN.)	MLP \$
S1-ZDMS0808	8 x 8	361.30
S1-ZDMS1008	10 x 8	367.01
S1-ZDMS1010	10 x 10	389.78
S1-ZDMS1208	12 x 8	372.82
S1-ZDMS1210	12 x 10	398.50
S1-ZDMS1212	12 x 12	398.39
S1-ZDMS1408	14 x 8	379.37
S1-ZDMS1410	14 x 10	405.50
S1-ZDMS1412	14 x 12	423.41
S1-ZDMS1414	14 x 14	430.88
S1-ZDMS1608	16 x 8	385.34
S1-ZDMS1610	16 x 10	413.25
S1-ZDMS1612	16 x 12	431.47

Zoning, Venting & Economizer Controls

ZONING DAMPERS

SOURCE 1 Rectangular Zoning Dampers

Side Mount (cont.)

SOURCE 1 PART NO.	SIZE (IN.)	MLP \$
S1-ZDMS1614	16 x 14	439.08
S1-ZDMS1616	16 x 16	461.64
S1-ZDMS1808	18 x 8	391.18
S1-ZDMS1810	18 x 10	420.00
S1-ZDMS1812	18 x 12	441.45
S1-ZDMS1814	18 x 14	447.11
S1-ZDMS1816	18 x 16	464.62
S1-ZDMS1818	18 x 18	470.43
S1-ZDMS2008	20 x 8	398.90
S1-ZDMS2010	20 x 10	426.97
S1-ZDMS2012	20 x 12	449.57
S1-ZDMS2014	20 x 14	457.59
S1-ZDMS2016	20 x 16	479.23
S1-ZDMS2018	20 x 18	477.24
S1-ZDMS2020	20 x 20	511.45
S1-ZDMS2208	22 x 8	403.70
S1-ZDMS2210	22 x 10	432.50
S1-ZDMS2212	22 x 12	456.82
S1-ZDMS2214	22 x 14	448.87
S1-ZDMS2216	22 x 16	477.24
S1-ZDMS2218	22 x 18	505.46
S1-ZDMS2220	22 x 20	530.99
S1-ZDMS2222	22 x 22	567.78
S1-ZDMS2408	24 x 8	410.54
S1-ZDMS2410	24 x 10	439.43
S1-ZDMS2412	24 x 12	445.78
S1-ZDMS2414	24 x 14	474.63
S1-ZDMS2416	24 x 16	499.86
S1-ZDMS2418	24 x 18	516.83
S1-ZDMS2420	24 x 20	564.25
S1-ZDMS2422	24 x 22	576.25
S1-ZDMS2424	24 x 24	610.32
S1-ZDMS2608	26 x 8	390.01
S1-ZDMS2610	26 x 10	431.29
S1-ZDMS2612	26 x 12	453.73
S1-ZDMS2614	26 x 14	467.01
S1-ZDMS2616	26 x 16	540.78
S1-ZDMS2618	26 x 18	564.25
S1-ZDMS2620	26 x 20	573.45
S1-ZDMS2622	26 x 22	598.94
S1-ZDMS2624	26 x 24	624.48
S1-ZDMS2808	28 x 8	409.39
S1-ZDMS2810	28 x 10	463.00
S1-ZDMS2812	28 x 12	471.17
S1-ZDMS2814	28 x 14	491.97
S1-ZDMS2816	28 x 16	545.19
S1-ZDMS2818	28 x 18	577.90
S1-ZDMS2820	28 x 20	579.08
S1-ZDMS2822	28 x 22	604.66
S1-ZDMS2824	28 x 24	630.16
S1-ZDMS3008	30 x 8	419.69
S1-ZDMS3010	30 x 10	464.76
S1-ZDMS3012	30 x 12	459.00
S1-ZDMS3014	30 x 14	500.04
S1-ZDMS3016	30 x 16	559.36
S1-ZDMS3018	30 x 18	596.12
S1-ZDMS3020	30 x 20	610.32
S1-ZDMS3022	30 x 22	635.75
S1-ZDMS3024	30 x 24	666.94
S1-ZDMS3208	32 x 8	407.07
S1-ZDMS3210	32 x 10	479.41
S1-ZDMS3212	32 x 12	500.31
S1-ZDMS3214	32 x 14	485.89
S1-ZDMS3216	32 x 16	570.66
S1-ZDMS3218	32 x 18	607.49
S1-ZDMS3220	32 x 20	624.48
S1-ZDMS3222	32 x 22	658.41
S1-ZDMS3224	32 x 24	683.94
S1-ZDMS3408	34 x 8	412.67
S1-ZDMS3410	34 x 10	494.71
S1-ZDMS3412	34 x 12	511.12
S1-ZDMS3414	34 x 14	510.98
S1-ZDMS3416	34 x 16	581.95
S1-ZDMS3418	34 x 18	646.37
S1-ZDMS3420	34 x 20	641.49
S1-ZDMS3422	34 x 22	672.58
S1-ZDMS3424	34 x 24	700.97
S1-ZDMS3608	36 x 8	418.30
S1-ZDMS3610	36 x 10	516.83

Zoning, Venting & Economizer Controls

ZONING DAMPERS

SOURCE 1 Rectangular Zoning Dampers

Side Mount

SOURCE 1 PART NO.	SIZE (IN.)	MLP \$
S1-ZDMS3612	36 x 12	533.25
S1-ZDMS3614	36 x 14	506.49
S1-ZDMS3616	36 x 16	596.12
S1-ZDMS3618	36 x 18	660.92
S1-ZDMS3620	36 x 20	658.41
S1-ZDMS3622	36 x 22	692.44
S1-ZDMS3624	36 x 24	720.15

NOTE: S1-ZDMS DAMPERS CAN BE USED AS MODULATING POWERED BYPASS DAMPERS WHEN APPLIED WITH S1-SPS STATIC PRESSURE ZONING SWITCH.

BY-PASS DAMPERS

SOURCE 1 Barometric By-Pass Dampers

SOURCE 1 Round Barometric Bypass Dampers

SOURCE 1 PART NO.	SIZE (IN.)	MLP \$
S1-SPRD08	8	89.84
S1-SPRD09	9	95.74
S1-SPRD10	10	99.79
S1-SPRD12	12	115.09
S1-SPRD14	14	126.83
S1-SPRD16	16	140.22
S1-SPRD18	18	160.31
S1-SPRD20	20	205.38

SOURCE 1 Barometric By-Pass Dampers

SOURCE 1 Rectangular Barometric Bypass Dampers

SOURCE 1 PART NO.	SIZE (IN.)	MLP \$
S1-SPRD1208	12 x 8	112.25
S1-SPRD1210	12 x 10	120.83
S1-SPRD1212	12 x 12	122.96
S1-SPRD2008	20 x 8	117.81
S1-SPRD2010	20 x 10	126.93
S1-SPRD2012	20 x 12	128.21

Zoning, Venting & Economizer Controls

ECONOMIZER CONTROLS & ECONOMIZER LOGIC MODULES

Honeywell C7660 Selectable Temperature Sensor



Honeywell C7660 Selectable Temperature Sensor C7660 Selectable Temperature Sensor is used with the W7459, W7215, W7213 and W7214 Economizer Controls. The economizer controls are mounted on an M7415/M7215 Actuator. They permit the use of outdoor air as the first stage of cooling in heating, ventilating and air conditioning (HVAC) systems. The C7660 Selectable Temperature Sensor is only to be used with single temperature change over with the sensor located in the outdoor air.

Features:

- Senses temperature of outdoor air and provides a signal to economizer control with OK or not OK to economize.
- Selectable dip switch provides 8 change over temperature options.
- When temperature of outdoor air is below change over temperature, the outdoor air damper is opened to reduce the cooling load in the building.
- Provides 4 OR 20 mA output signal to economizer control; At 4 mA not OK to economize, 20 mA OK to economize.
- Highly accurate microprocessor control.
- Sensor is enclosed in a rugged, corrosion-resistant plastic case.
- Replaces C7650 temperature sensors and the control function of temperature change over in the economizer control.
- Easy to set change real time temperature settings. The installer can change the temperature set point without cutting power to the system.

Specifications:

Model: C7660 Selectable Temperature Sensor , Case: Duct mount

Temperature Sensing Element: Thermistor

Output Signal: 4mA not OK to economize, 20 mA OK to economize

Operating Ambient Temperature Range: -40° to 149° F (-40° to 65° C).

Shipping Temperature Range: -40° to 149° F (-40° to 65° C).

Supply Voltage: Power to sensor is supplied through economizer or if not used with an economizer, logic power input is 21.6 vdc ± 1.5 vdc. Electrical Connections: Two 1/4 in. (6.4 mm) quick connect terminals.

Approval: Underwriters Laboratories Inc. Flammability Rating UL94-5V

Dimensions: 3-5/32" H x 3-7/8" W x 1" D

Hysteresis: Hysteresis +/- 1F; Economizer Cut-in 1F below setpoint, Cut-out 1F above setpoint ,

Accuracy: ± 1° F

VENTILATION & INDOOR AIR QUALITY

SOURCE 1 PART NO.	APPLICATION TYPE	MOUNTING	USED WITH	MLP \$
S1-C7660A1000	DUCT OUTSIDE (SUPPLY) OR RETURN	IN ANY LOCATION WHERE IT IS EXPOSED TO FREELY CIRCULATING AIR	W7210, W7212, W7213, W7214, W7216, W7459, W7460	65.53

DAMPER ACTUATORS

Johnson Controls Electric Non-Spring-Return Actuators

M2903 Series



Description

The M9203-xxx-2(Z) Series Electric Spring Return Actuators provide control of dampers in HVAC systems. All actuators in this series provide 27 lb · in (3 N · m) rated torque. A mechanical spring return system provides rated torque with and without power applied to the actuator. The series includes the following control options:

- On/Off, 24 V, 85 to 264 VAC power
- On/Off and Floating Point, 24 V power
- Proportional, 24 V power, for 0(2) to 10 VDC or 0(4) to 20 mA Control Signal

These actuators are configured for direct mounting and do not require a damper linkage. Actuators can be mounted directly to a damper shaft from 1/4 to 1/2 inch (6 to 12 mm) diameter with a universal clamp.

Features

- 27 lb · in (3 N · m) rated torque
- Direct-coupled design
- Reversible mounting
- Electronic Stall detection
- Double-insulated construction
- Microprocessor-controlled brushless DC motor (-AGx and -GGx types)
- External mode selection switch (-AGx and -GGx types)
- Integral cables with colored and numbered conductors
- Integral 1/2 inch (13 mm) threaded conduit connectors
- Optional integrated auxiliary switch
- Plenum rated models
- Override control (proportional models only)
- Underwriters Laboratories Inc.® (UL), CE, and C-Tick compliance
- Manufactured under International Standards Organization (ISO) 9001 quality control standards
- 5-year warranty

SOURCE 1 PART NO.	DESCRIPTION	CODE NO.	CONTROL TYPE	ELECTRICAL CONNECTIONS	MLP \$
S1-M9203-BGA-2	MTR, ACTUATOR, ROTARY, 24VAC, 80IN-LB	M90109-GGA-2	ON/OFF	48 IN. (1.2 M) 18 AWG PLENUM CABLE, 1/2" CONDUIT CONNECTORS	294.85
S1-M9203-GGA-2Z	MTR, ACTUATOR, SPRG RET, 24VAC/DC, 27 IN-LB	M9203-GGA-2Z	0(2) TO 10 VDC	120 IN. (3.05 M) 19 AWG PLENUM CABLE, 1/2" CONDUIT CONNECTORS	292.43

Johnson Controls Electric Spring-Return Actuators

M9208 Series



Description

The M9208-xxx-x Series Electric Spring-Return Actuators provide control of dampers in HVAC systems. All actuators in this series provide 70 lb · in (8 N · m) rated torque. A mechanical spring-return system provides rated torque with and without power applied to the actuator. The series includes the following control options:

- On/Off, 24 V, 120 VAC, 230 VAC power
- On/Off and Floating Point, 24 V power
- Proportional, 24 V power, for 0(2) to 10 VDC or 0(4) to 20 mA Control Signal

These actuators are configured for direct mounting and do not require a damper linkage. Actuators can be mounted directly to a damper shaft from 5/16 to 5/8 in. (8 to 16 mm) diameter with a universal clamp. For shafts up to 3/4 in. (19 mm) diameter, use the accessory Large Shaft Coupler Kit M9208-600. An accessory crank arm and remote mounting kit are available for applications where the actuator cannot be direct coupled to the damper shaft. Optional line voltage auxiliary switches indicate an end-stop position or perform switching functions within the selected rotation range.

Features

- 70 lb · in (8 N · m) rated torque
- Direct-coupled design
- Reversible mounting
- Electronic stall detection
- Double-insulated construction
- Microprocessor-controlled brushless DC motor (-AGx and -GGx types)
- External mode selection switch (-AGx and -GGx types)
- Locking manual override with auto release and crank storage
- Integral cables with colored and numbered conductors
- Integral connectors for 3/8 in. (10 mm) Flexible Metal Conduit (FMC)
- Optional integrated auxiliary switches
- UL, CE, and C-Tick compliance
- Manufactured under International Standards Organization (ISO) 9001 quality control standards
- 5-year warranty
- 48 in. (1.2 m) 18 AWG Appliance Cable. Integral 3/8 in. (10 mm) FMC Connectors

SOURCE 1 PART NO.	DESCRIPTION	CODE NO.	CONTROL TYPE	MLP \$
S1-M9208-GGA-3	MTR,ACTUATOR,SPRG RET,24VAC/DC,70 IN-LB	M9208-GGA-3	0(2) TO 10 VDC	340.33

DAMPER ACTUATORS

Johnson Controls Electric Spring-Return Actuators

M9220 Series



Description

The M9220-xxx-3 actuators are direct-mount, spring-return electric actuators that operate with these available power options:

- AC 24 V at 50/60 Hz or DC 24 V (AGx, BGx, GGx, HGx)
- AC 120 V at 60 Hz (BAx)
- AC 230 V at 50/60 Hz (BDx)

These bidirectional actuators do not require a damper linkage, and are easily installed on dampers with 1/2 to 3/4 in. or 12 to 19 mm round shafts, or 3/8 and 1/2 in. or 10, 12, and 14 mm square shafts using the standard shaft clamp included with the actuator. An optional M9220-600 Jackshaft Coupler Kit is available for 3/4 to 1-1/16 in. or 19 to 27 mm round shafts, or 5/8 and 3/4 in. or 16, 18, and 19 mm square shafts.

A single M9220-xxx-3 Electric Spring-Return Actuator provides a running and spring-return torque of 177 lb · in (20 N · m). Two or three models mounted in tandem deliver twice or triple the torque. Integral line voltage auxiliary switches are available on the -xxC models to indicate end-stop position or to perform switching functions within the selected rotation range.

Refer to the M9220-xxx-3 Electric Spring-Return Actuators Product Bulletin (LIT-12011057) for important product application information.

Features

- Available Torques of 177 lb · in (20 N · m) for Single Actuators, 354 lb · in (40 N · m) for Two Models, and 531 lb · in (60 N · m) for three models mounted in Tandem – offer a selection that is most suitable for the application.
- Reversible Mounting Design – simplifies installation and enables the actuator to spring return in either direction.
- Electronic Stall Detection throughout Entire Rotation Range – extends the life of the actuator by deactivating the actuator motor when an overload condition is detected.
- Removable Coupler – adapts to a shorter damper shaft.
- Integral 48 in. (1.2m) Halogen-Free Cables with Colored and Numbered Conductors – simplify field wiring.
- Integral Auxiliary Switches (xxC Models) – provide one fixed and one adjustable switch point with line voltage capability.
- NEMA 2 (IP54) Rated Aluminum Enclosure – protects the internal components of the actuator from dirt and moisture.
- Easy-to-Use Locking Manual Override with Auto Release and Crank Storage – allows for manual positioning of the actuator hub.
- Integral Connectors for 3/8 in. Flexible Metal Conduit – simplify installation and field wiring.
- Microprocessor-Controlled Brushless DC Motor (-AGx, -GGx, and -HGx types) - provides constant run-time independent of torque.
- Auxiliary Switches: None
- Power Requirements: ac 24 v AT 50/60 Hz or DC 24 V

Applications

The M9220-xxx-3 Electric Spring-Return Actuators provide reliable control of dampers and valves in HVAC systems. The M9220-xxx-3 Actuators are available for use with on/off, floating, and proportional controllers.

SOURCE 1 PART NO.	DESCRIPTION	CODE NO.	CONTROL TYPE	MLP \$
S1-M9220-BGA-3	MTR, ACTUATOR, SPRG RET, 24VAC/DC, 177 IN-LB	M9220-BGA-3	ON/OFF	406.01
S1-M9220-GGA-3	MTR, ACTUATOR, SPRG RET, 24VAC/DC, 177 IN-LB	M9220-GGA-3	PROPORTIONAL	434.56

Johnson Controls Direct Mount Actuator Accessories

Valve Linkages

SOURCE 1 PART NO.	DESCRIPTION	MLP \$
S1-M9000-561	THERMAL BARRIER FOR m9000-551 AND m9000-560 BALL VALVE LINKAGES PERMITS USE OF M(VA)9XXX ACTUATORS ON VG1000 VALVES WITH LOW-PRESSURE STEAM	31.47

Zoning, Venting & Economizer Controls

PROPORTIONAL MOTORS

Honeywell M9185 MODUTROL IV MOTORS



Reversing, proportional, spring-return motors used to operate dampers and valves when used in a series 90 control circuit.

Features:

- M9185 replaces M945A,D,F and M955 motors.
- Can be adapted to series 70 control with interface modules.
- Contain integral helical springs to return motor shafts to normal position (full closed for M9175 and M9185, full open for M9186) on power interruption.
- Oil-immersed motor and gear train provide reliable performance and long life.
- Provide NEMA 3 weather protection with wiring box, when mounted upright.
- Up to six Modutrol motors can be driven by one series 90 controller using 4074BYK Resistor Bag Assembly or 221508A Resistor Board.
- Internal actuator motor and circuitry operate from 24 VAC. Line voltage model shipped with internal transformer.
- Double-ended, 3/8" (10 mm) square crankshaft.

Specifications:

Type of Control: Electric

Control Signal: Proportional Control, 135 ohm

Feedback: No

Fixed Stroke: No

Stroke: 90 deg Minimum, 160 deg, in Maximum

External Aux. Switches Available: Yes

Power Consumption: 24 VA

Electrical Connections: Quick connect terminals

Approvals: Underwriters Laboratories Inc. File E4436, Guide XAPX; Canadian Standards Association File LR1620, Guide 400-E; CE Standard EN55011 (Emission) EN50082-2 (Immunity) 73/23/EEC (LVD)

Motor Shafts: 2

Shaft Dimensions: 9.5 mm

Shaft Shape: Square

Manual Operation: None

Weight: 9.562 Lbs.

Dimensions: 6.45"H x 5.5"W x 8.76"D (164 mm H x 140 mm W x 223 mm D)

Includes: 220738A Adapter Bracket

SOURCE 1 PART NO.	VOLTAGE	SPRING RETURN	TORQUE/FORCE	TIMING		FREQUENCY	MOUNTING TYPE	AMBIENT TEMPERATURE RANGE	MLP \$
				MIN	MAX				
S1-M9185D1004	24VAC	YES	60 LB.-IN. (6.8 NM)	30 SEC.	60	50/60 HZ	FOOT MOUNTED	-40°F TO +150°F (-40°C TO +66°C)	1631.10

Honeywell Signal Interface Module



Interface module for Modutrol IV motor. For use with Series 91 Mod IV Motors.

Specifications:

Type of Control: Electric

Control Signal: Provides adjustable zero and span, voltage or current control (includes 2-10 Vdc or 4-20 mA). Adapts M91xx to function as M72xx model.

Electrical Connections (in): Terminal board

Mounting Type: Mounts to quick-connects inside Mod Motor

Dimensions: Fits inside wiring junction box of Modutrol IV Motor

SOURCE 1 PART NO.	FREQUENCY	POWER CONSUMPTION	WEIGHT	FREQUENCY	MOUNTING TYPE	AMBIENT TEMPERATURE RANGE	MLP \$
S1-Q7230A1005	24VAC	YES	60 LB.-IN. (6.8 NM)	50/60 HZ	FOOT MOUNT-ED	-40°F TO +150°F (-40°C TO +66°C)	310.05

Source 1 Motors

HIGH-AMBIENT CONDENSER FAN MOTORS



Features:

- High Temp 70°C ambient design
- Installs with all standard 48 frame mounting brackets
- Standard shaft length, diameter, and flats
- Drain holes with plugs in both end plates
- Automatic thermal overload protector
- Uses standard 370V capacitor
- Standard motor casing size
- Low power consumption
- Electrically reversible
- Continuous duty air over
- Class B insulation
- Quiet operation
- Extended studs
- 30" leads
- 60Hz

SOURCE 1 PART NO.	HP	VOLTS	RATED		SPEED	BEARINGS	370V CAPACITOR	DIM. A	WT. (LBS)	MLP \$
			FLA	LRA						
S1-FHM3469HT	1/3-1/6	208/230	2.0	825/2		BALL	S1-CAP37075F,S1-CAP37100F	5.25	14.5	243.81
S1-FHM3728HT	1/4	208/230	1.7	3.80	1075/1	BALL	S1-CAP37050F,S1-CAP37050R	4.25	12	184.74
S1-FHM3729HT	1/3	208/230	2.6	5.40	1075/1	BALL	S1-CAP37075F,S1-CAP37075R	4.52	12	210.62
S1-FHM3730HT	1/2	208/230	3.0	7.80	1075/1	BALL	S1-CAP37100F,S1-CAP37100R	5.29	16.28	242.77
S1-FHM3204HT	1/4	208/230	1.3	2.40	825/1	BALL	S1-CAP37075F,S1-CAP37075R	4.25	12	232.83
S1-FHM3205HT	1/3	208/230	1.8	3.30	825/1	BALL	S1-CAP37100F,S1-CAP37100R	4.53	12	256.90
S1-FHM3736HT	1/4	460	0.7	1.65	1075/1	BALL	S1-CAP37075F,S1-CAP37075R	4.25	12.1	232.42
S1-FHM3737HT	1/3	460	1.2	2.85	1075/1	BALL	S1-CAP37075F,S1-CAP37075R	5.32	12.1	270.91
S1-FHM3738HT	1/2	460	1.7	4.30	1075/1	BALL	S1-CAP37100F,S1-CAP37100R	5.75	16.28	312.83
S1-FHM3739HT	3/4	460	2.03	5.30	1075/1	BALL	S1-CAP37100F,S1-CAP37100R	6.1	22	396.50
S1-FHM3465HT	1/3-1/6	208/230	2.5	1075/2		BALL	S1-CAP37050F,S1-CAP37075F	5.0	13.6	243.89

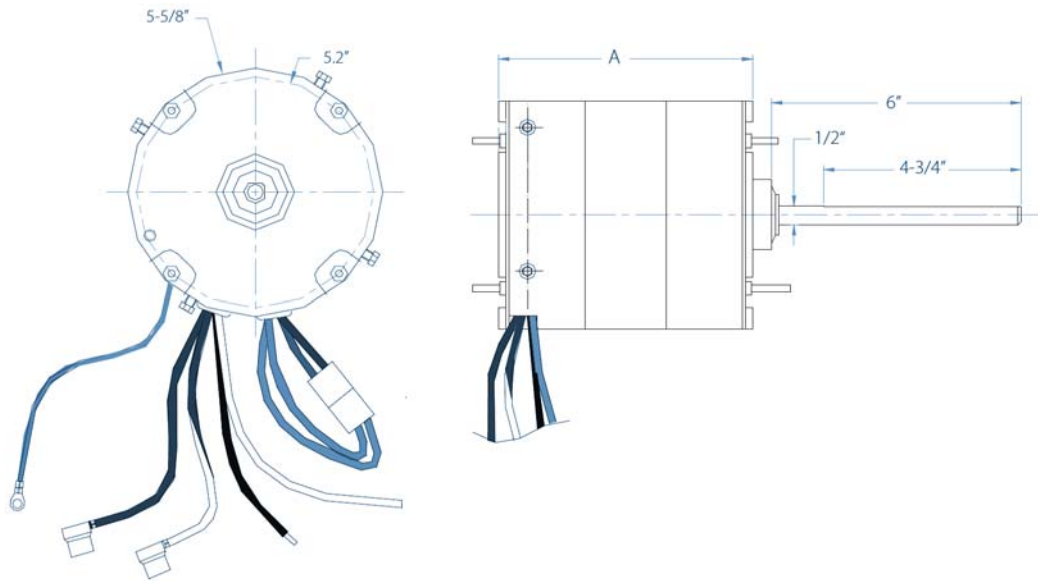

Cross Reference

SOURCE 1 PART NO.	AO SMITH *	AO SMITH HEAT MASTER	GE*	FASCO*	EMERSON*
S1-FHM3728HT	FSE1026S	FSE1026SF	3728	D909	1860
S1-FHM3729HT	FSE1036S	FSE1036SF	3729	D908	1861
S1-FHM3730HT	FSE1056S	FSE1056SF	3730	D907	1862
S1-FHM3204HT	FSE1028S	FE1028SF	3204	D743	1874
S1-FHM3205HT	FSE1038S	FE1038SF	3205	D796	1875
S1-FHM3736HT	FEH1026S	FEH1026SF	3736	D980	3736
S1-FHM3737HT	FEH1036S	FEH1036SF	3737	D982	3737
S1-FHM3738HT	FEH1056S	FEH1056SF	3738	D802	3738
S1-FHM3739HT	FEH1076	FEH1076SF	3739	D1914	3742
S1-FHM3465HT	FE6000	ORM5458BF	3465	D2827	5462
S1-FHM3469HT	FE6001	ORM5488BF	3469	D2826	5464

* Competitors' motors are only rated for 60°C ambient.

Source 1 Motors

SINGLE HORSEPOWER CONDENSER FAN MOTORS



Features:

- Installs with all standard 48 frame mounting brackets
- Standard shaft length, diameter, and flats
- Drain holes with plugs in both end plates
- Automatic thermal overload protector
- Uses standard 370V capacitors
- Standard motor casing size
- Low power consumption
- 60°C ambient design
- Electrical reversing plug
- Continuous air over
- Class B insulation
- Quiet operation
- Extended mounting bolts
- 30" leads
- Rotation reversible
- Single phase
- 2-year warranty!

Specifications:

Voltage: 208/230 VAC; 60 Hz

SOURCE 1 PART NO.	HP	RPM	SPEED	RATED			BEARING TYPE	RUN CAPACITOR	REPLACES	MLP \$
				AMPS	FLA	LRA				
S1-FHM3204	1/4	825	1	2.4	1.3		BALL	S1-CAP37075F,S1-CAP37075R	EMERSON:1874,AOS:FSE1028S,GE:3204	185.50
S1-FHM3205	1/3	825	1	3.3	1.9		BALL	S1-CAP37100F,S1-CAP37100R	EMERSON:1875,AOS:FSE1038S,GE:3205	210.21
S1-FHM3727	1/6	1075	1	1.2	1.0	1.5	BALL	S1-CAP37050F,S1-CAP37050R	EMERSON:1859,AOS:FSE1016S,GE:3727	132.53
S1-FHM3728	1/4	1075	1	1.9	1.8	2.4	BALL	S1-CAP37050F,S1-CAP37050R	EMERSON:1860,AOS:FSE1026S,GE:3728	134.99
S1-FHM3729	1/3	1075	1	3.2	2.4	4.0	BALL	S1-CAP37075F,S1-CAP37075R	EMERSON:1861,AOS:FSE1036S,GE:3729	167.55
S1-FHM3730	1/2	1075	1	3.8	3.3	5.3	BALL	S1-CAP37100F,S1-CAP37100R	EMERSON:1862,AOS:FSE1056S,GE:3730	200.55
S1-FHM3731	3/4	1075	1	4.6	4.7	5.9	BALL	S1-CAP37100F,S1-CAP37100R	EMERSON:1868,AOS:FSE1076S,GE:3731	226.22

SINGLE HORSEPOWER BLOWER MOTORS



Features:

- Installs with all standard 48 frame mounting brackets
- Standard shaft length, diameter, and flats
- Automatic thermal overload protector
- Standard motor casing size
- 2.5" dia. hub rings included
- Low power consumption
- Continuous duty, air over
- Uses 370V capacitors
- Electrical reversing plug
- Class B insulation
- Quiet operation
- Rotation reversible
- Single phase
- 2-year warranty!

Specifications:

60 Hz

SOURCE 1 PART NO.	HP	RPM	SPEED	RATED			VOLTS	BEARING TYPE	RUN CAPACITOR	REPLACES	MLP \$
				AMPS	FLA	LRA					
S1-FHM3583	1/4	1075	3	4.2	10	6.3	115	BALL	S1-CAP37050F,S1-CAP37050R	EMERSON:1863,AOS:DL1026,GE:3583	143.11
S1-FHM3584	1/4	1075	3	1.8	4.3	2.7	208/230	BALL	S1-CAP37050F,S1-CAP37050R	EMERSON:1971,AOS:D1026,GE:3584	145.09
S1-FHM3586	1/3	1075	3	2.7	6.4	3.9	208/230	BALL	S1-CAP37050F,S1-CAP37050R	EMERSON:1972,AOS:D1036,GE:3586	163.46
S1-FHM3587	1/2	1075	3	7.5	20	12.7	115	BALL	S1-CAP37100F,S1-CAP37100R	EMERSON:1865,AOS:DL1056,GE:3587	196.95
S1-FHM3588	1/2	1075	3	3.2	10.6	6.8	208/230	BALL	S1-CAP37075F,S1-CAP37075R	EMERSON:1973,AOS:D1056,GE:3588	198.81
S1-FHM3589	3/4	1075	3	10.5	22.7	13.7	115	BALL	S1-CAP37150F	EMERSON:8904,AOS:DL1076,GE:3589	190.46
S1-FHM3590	3/4	1075	3	4.5	11.1	7.3	208/230	BALL	S1-CAP37100F,S1-CAP37100R	EMERSON:8905,AOS:D1076,GE:3590	205.77
S1-FHM3595	1	1075	3	11.8	24.5	12.6	115	BALL	S1-CAP44200F,S1-CAP44200R	EMERSON:8906,AOS:BDL1106,GE:3595	311.81
S1-FHM3596	1	1075	3	5.59	10.5	5.59	208/230	BALL	S1-CAP37150F	AOS:BD1106,GE:3596	314.12
S1-FHM3585	1/3	1075	3	6.1	13.1	8.2	115	BALL	S1-CAP37050F,S1-CAP37050R	EMERSON:1864,AOS:DL1036,GE:3585	160.97

Timesaver™ Multi-HP PSC Motors

BLOWER

SOURCE 1 PART NO.	VOLTAGE	HZ	RPM	MAX FLA	BEARINGS	LEADS	MLP \$
S1-FHM3463	115V	60	1075	5.6	BALL	36"	194.92
S1-FHM3464	208/230V	60	1075	2.7	BALL	36"	199.17
S1-FHM3466	115V	60	1075	8.3	BALL	36"	233.96
S1-FHM3467	208/230V	60	1075	4.2	BALL	36"	241.10

SOURCE 1 PART NO.	MAX HP	COOLING	HEATING	CAP (MFD)
S1-FHM3463	1/2	HI	MED-HI; MED-LO	10
	1/3			5 OR 7.5
	1/4	MED-HI	MED-HI; LO	
	1/5	MED-LO	LO	
	1/6	LO	LO	
S1-FHM3464	1/2	ALL SPEEDS	MED-LO	10
	1/3			5 OR 7.5
	1/4	MED-HI; MED-LO; LO	LO	
	1/5	MED-LO; LO		
	1/6	LO		
S1-FHM3466	3/4	ALL SPEEDS	MED-LO	20
	1/2			10
	1/3	MED-HI; MED-LO; LO	LO	
	1/4	MED-LO; LO		
	1/5	LO		
S1-FHM3467	3/4	ALL SPEEDS	MED-LO	20
	1/2			10
	1/3	MED-HI; MED-LO; LO	LO	
	1/4	MED-LO; LO		
	1/5	LO		

CONDENSER

SOURCE 1 PART NO.	VOLTAGE	HZ	RPM	MAX FLA	BEARINGS	LEADS	MLP \$
S1-FHM3465	208/230V	60	1075	2.6	BALL	36"	184.37
S1-FHM3469	208/230V	60	825	2.2	BALL	36"	200.40
S1-FHM3468	208/230V	60	1075	3.6	BALL	36"	213.30

SOURCE 1 PART NO.	MAX HP	SPEED TAP	CAP AT 208V LINE (MFD)	CAP AT 230V LINE (MFD)
S1-FHM3465	1/3	HI	7.5	5
	1/4			
	1/5	LO		
	1/6			
S1-FHM3469	1/3	HI	10	7.5
	1/4			
	1/5	LO		
	1/6			
S1-FHM3468	1/2	HI	12.5	10
	1/3			
	1/4	LO		
	1/5			

MOTORS & MOTOR ACCESSORIES

Timesaver Multi-HP PSC Motors

CAPACITOR SELECTION GUIDE FOR S1-FHM SERIES MULTI-HORSEPOWER MOTORS

MOTOR MODELS	HP	SPEED	CAPACITORS	MOTOR MODELS	HP	SPEED	VOLTAGE	CAPACITORS			
S1-FHM3463 & S1-FHM3464	1/2	ALL	S1-CAP37100F	S1-FHM3465W	1/3	HI	208	S1-CAP37075F			
			S1-CAP37100R					S1-CAP37075R			
	1/3	ALL	S1-CAP37050F				230	1/4	HI	208	S1-CAP37050F
			S1-CAP37050R								S1-CAP37050R
			S1-CAP37075F				230			208	S1-CAP37075F
			S1-CAP37075R								S1-CAP37075R
	1/4	MED-HI, MED-LO, LO	S1-CAP37050F		208	1/5	LO	208	S1-CAP37050F		
			S1-CAP37050R						S1-CAP37050R		
			S1-CAP37075F		230			208	S1-CAP37075F		
			S1-CAP37075R						S1-CAP37075R		
	1/5	MED-LO, LO	S1-CAP37050F		230	1/6	LO	208	S1-CAP37050F		
			S1-CAP37050R						S1-CAP37050R		
			S1-CAP37075F		230			208	S1-CAP37075F		
			S1-CAP37075R						S1-CAP37075R		
	1/6	LO	S1-CAP37050F		230	1/2	HI	208	S1-CAP37050F		
			S1-CAP37050R						S1-CAP37050R		
			S1-CAP37075F		230			208	S1-CAP37075F		
			S1-CAP37075R						S1-CAP37075R		
	S1-FHM3466 & S1-FHM3467	3/4	ALL		S1-CAP37200F	S1-FHM3468	1/3	HI	230	S1-CAP37125F	
		1/2	ALL		S1-CAP37100F		1/4	LO	208	S1-CAP37100F	
S1-CAP37100R				S1-CAP37100R							
1/3		MED-HI, MED-LO, LO	S1-CAP37100F	230	1/5		LO	208	S1-CAP37100F		
			S1-CAP37100R						S1-CAP37100R		
1/4		MED-LO, LO	S1-CAP37100F	230	1/3		HI	208	S1-CAP37100F		
			S1-CAP37100R						S1-CAP37100R		
1/5		LO	S1-CAP37100F	230	1/4		HI	208	S1-CAP37100F		
			S1-CAP37100R						S1-CAP37100R		
S1-FHM3469		1/3	HI	S1-CAP37100F	S1-FHM3469		1/3	HI	208	S1-CAP37100F	
				S1-CAP37100R						S1-CAP37100R	
		230	S1-CAP37075F								
	S1-CAP37075R										
	1/4	HI	208	S1-CAP37100F		208	1/4	HI	S1-CAP37100F		
				S1-CAP37100R					S1-CAP37100R		
			230	S1-CAP37075F		230			S1-CAP37075F		
				S1-CAP37075R					S1-CAP37075R		
	1/5	LO	208	S1-CAP37100F		208	1/5	LO	S1-CAP37100F		
				S1-CAP37100R					S1-CAP37100R		
			230	S1-CAP37075F		230			S1-CAP37075F		
				S1-CAP37075R					S1-CAP37075R		
1/6	LO	208	S1-CAP37100F	208	1/6	LO	S1-CAP37100F				
			S1-CAP37100R				S1-CAP37100R				
		230	S1-CAP37075F	230			S1-CAP37075F				
			S1-CAP37075R				S1-CAP37075R				

MOTORS & MOTOR ACCESSORIES

Timesaver Multi-HP PSC Motors

DIRECT DRIVE BLOWER MOTORS

S1-FHM3463

Features:

- Reversible rotation
- Ambient: 40°C
- Open enclosure
- 2" x 4.5" shaft (flatted)
- Resilient rings
- Extended thru bolts
- Automatic protector

This Time Saver motor replaces all motors in the cross reference table below.

SOURCE 1 PART NO.	VOLTAGE	RPM	MAX FLA	BEARINGS	LEADS	MLP \$
S1-FHM3463	115	1075	5.6	BALL	36"	194.92

SOURCE 1 PART NO.	MAX HP	COOLING	HEATING	CAP (MFD)
S1-FHM3463	1/2	HI	MED-LO	10
	1/3	HI	MED-LO	5
	1/4	MED-HI	LO	5
	1/5	MED-LO	LO	5
	1/6	LO	LO	5

CROSS REFERENCE FOR TIME SAVER™ S1-FHM3463 - BLOWER, DIRECT DRIVE, 1/6-1/2 HP, 115V

SOURCE 1 PART NO.	APP	DRIVE	HP	RPM	SPEED	ROTA-TION	VOLTS	PHASE	HZ	FRAME	BEARING	ENCLOSURE	ORIENT
S1-14680425P	BLOWER	DIRECT	1/6	860	2	CCWEOS	115	1	60	48	BALL	OPEN	VSUDH
S1-2632E3129	BLOWER	DIRECT	1/6	950	MULTI	CWLE	115				BALL		
S1-2632E3129	BLOWER	DIRECT	1/6	1050	MULTI	CWLE	115				BALL		
S1-7966-311P	BLOWER	DIRECT	1/6	900	1	CCWEOS	115	1	60	42	BALL	OPEN	HORIZONTAL
S1-02423209701	BLOWER	DIRECT	1/5	1075	3	CCWEOS	115	1	60	48	BALL	OPEN	HORIZONTAL
S1-02423220000	BLOWER	DIRECT	1/5	1075	3	CCWEOS	115	1	60	48	BALL	ODP	HORIZONTAL
S1-02423220700	BLOWER	DIRECT	1/5	1075	3	CCWEOS	115	1	60	48	BALL	ODP	HORIZONTAL
S1-02423239000	BLOWER	DIRECT	1/5	1075	3	CCWEOS	115	1	60	48	BALL	ODP	HORIZONTAL
S1-024232239700	BLOWER	DIRECT	1/5	1075	3	CCWEOS	115	1	60	48	BALL	ODP	HORIZONTAL
S1-02425101701	BLOWER	DIRECT	1/5	1075	3	CCWEOS	115	1	60	48	BALL	ODP	HORIZONTAL
S1-02425107701	BLOWER	DIRECT	1/5	1075	3	CCWEOS	115	1	60	48	BALL	ODP	HORIZONTAL
S1-02425879700	BLOWER	DIRECT	1/5	1000	3	CCWEOS	115	1	60	48	BALL	ODP	HORIZONTAL
S1-02425879701	BLOWER	DIRECT	1/5	1000	2	CCWEOS	115	1	60	48	BALL	ODP	HORIZONTAL
S1-02630511000	BLOWER	DIRECT	1/5	1000	2	CCW	115	1	60	42	BALL	ODP	HORIZONTAL
S1-2621A3129	BLOWER	DIRECT	1/5	950	MULTI	CWLE	115				BALL		
S1-2621A3129	BLOWER	DIRECT	1/5	1050	MULTI	CWLE	115				BALL		
S1-52430226000	BLOWER	DIRECT	1/5	1075	VARIABLE	REV	115	1	60	48	BALL	OPEN	
S1-8638-4129	BLOWER	DIRECT	1/5	1050		CCW	115				BALL		
S1-02417903703	BLOWER	DIRECT	1/4	1050	3	CCWEOS	115	1	60	42	BALL	OPEN	HORIZONTAL
S1-02420244701	BLOWER	DIRECT	1/4	1075	3	CWEOS	115	1	60	48	BALL	OPEN	HORIZONTAL
S1-02421620700	BLOWER	DIRECT	1/4	1050	2	CCWEOS	115	1	60	48	BALL	OPEN	VSUDH
S1-02421767700	BLOWER	DIRECT	1/4	900	3	CCWEOS	115	1	60	42	BALL	OPEN	HORIZONTAL
S1-02423219000	BLOWER	DIRECT	1/4	1075	3	CCWEOS	115	1	60	48	BALL	ODP	HORIZONTAL
S1-02423219700	BLOWER	DIRECT	1/4	1075	3	CCWEOS	115	1	60	48	BALL	ODP	HORIZONTAL
S1-02424150700	BLOWER	DIRECT	1/4	1075	3	REV	115	1	60	48	BALL	OPEN	HORIZONTAL
S1-02425010000	BLOWER	DIRECT	1/4	1075	3	CCWEOS	115	1	60	48	BALL	ODP	HORIZONTAL
S1-02425010700	BLOWER	DIRECT	1/4	1075	3	CCWEOS	115	1	60	48	BALL	ODP	HORIZONTAL
S1-02425105702	BLOWER	DIRECT	1/4	1075	3	CCWEOS	115	1	60	48	BALL	ODP	HORIZONTAL
S1-02425108701	BLOWER	DIRECT	1/4	1075	3	CCWEOS	115	1	60	48	BALL	ODP	HORIZONTAL
S1-02425108702	BLOWER	DIRECT	1/4	1075	3	CCWEOS	115	1	60	48	BALL	ODP	HORIZONTAL
S1-02425108703	BLOWER	DIRECT	1/4	1075	3	CCWEOS	115	1	60	48	BALL	ODP	HORIZONTAL
S1-02425109701	BLOWER	DIRECT	1/4	1075	3	CCWEOS	115	1	60	48	BALL	ODP	HORIZONTAL
S1-02425109702	BLOWER	DIRECT	1/4	1075	3	CCWEOS	115	1	60	48	BALL	ODP	HORIZONTAL
S1-02425942700	BLOWER	DIRECT	1/4	1050	3	CCWEOS	115	1	60		BALL	OPEN	HORIZONTAL
S1-1468-212P	BLOWER	DIRECT	1/4	1075	1	CCWEOS	115	1	60	48	BALL	OPEN	HORIZONTAL
S1-52432026-000	BLOWER	DIRECT	1/4	1075	VARIABLE	REV	115	1	60	42	BALL	OPEN	HORIZONTAL
S1-02417793000	BLOWER	DIRECT	1/3	1075	3	CCWEOS	115	1	60	48	BALL	ODP	
S1-02417793700	BLOWER	DIRECT	1/3	1075	3	CCWEOS	115	1	60	48	BALL	ODP	HORIZONTAL
S1-02423218000	BLOWER	DIRECT	1/3	1075	3	CCWEOS	115	1	60	48	BALL	ODP	HORIZONTAL
S1-02423218700	BLOWER	DIRECT	1/3	1075	3	CCWEOS	115	1	60	48	BALL	ODP	HORIZONTAL
S1-02423240000	BLOWER	DIRECT	1/3	1075	3	CCWEOS	115	1	60	48	BALL	ODP	HORIZONTAL
S1-02423240700	BLOWER	DIRECT	1/3	1075	3	CCWEOS	115	1	60	48	BALL	ODP	HORIZONTAL
S1-02423241000	BLOWER	DIRECT	1/3	1075	3	CCWEOS	115	1	60	48	BALL	ODP	HORIZONTAL
S1-02423241700	BLOWER	DIRECT	1/3	1075	3	CCWEOS	115	1	60	48	BALL	ODP	HORIZONTAL
S1-02424152700	BLOWER	DIRECT	1/3	1075	3	REV	115	1	60	48	BALL	OPEN	HORIZONTAL
S1-02425103702	BLOWER	DIRECT	1/3	1075	3	CCWEOS	115	1	60	48	BALL	ODP	HORIZONTAL
S1-02425112700	BLOWER	DIRECT	1/3	1075	3	CCWEOS	115	1	60	48	BALL	OPEN	HORIZONTAL
S1-02425114700	BLOWER	DIRECT	1/3	1075	3	CCWEOS	115	1	60	48	BALL	ODP	HORIZONTAL
S1-02431969000	BLOWER	DIRECT	1/3			CCWEOS	115				BALL		
S1-52432026000	BLOWER	DIRECT	1/3	1075	VARIABLE	REV	115	1	60	48	BALL	OPEN	
S1-8631A3239	BLOWER	DIRECT	1/3	1075		CW	115				BALL		

MOTORS & MOTOR ACCESSORIES

Timesaver Multi-HP PSC Motors

DIRECT DRIVE BLOWER MOTORS

S1-FHM3464



Features:

- Reversible rotation
- Ambient: 40°C
- Open enclosure

- 1/2" x 4.5" shaft (flatted)
- Resilient rings
- Extended thru bolts
- Automatic protector

This Time Saver motor replaces all motors in the cross reference table below.

SOURCE 1 PART NO.	VOLTAGE	RPM	MAX FLA	BEARINGS	LEADS	MLP \$
S1-FHM3464	208/230	1075	2.7	BALL	36"	199.17

SOURCE 1 PART NO.	MAX HP	COOLING	HEATING	CAP (MFD)
S1-FHM3464	1/2	HI	MED-LO	10
	1/3	HI	MED-LO	5
	1/4	MED-HI	LO	5
	1/5	MED-LO	LO	5
	1/6	LO	LO	5

CROSS REFERENCE FOR TIME SAVER™ S1-FHM3464 - BLOWER, DIRECT DRIVE, 1/6-1/2 HP, 208-230V

SOURCE 1 PART NO.	APP	DRIVE	HP	RPM	SPEED	ROTATION	VOLTS	PHASE	HZ	FRAME	BEARING	ENCLOSURE	ORIENT
S1-02421634000	BLOWER	DIRECT	1/6	925	1		208-230	1	60		BALL		
S1-02421634700	BLOWER	DIRECT	1/6	925	1		208-230	1	60		BALL		
S1-02421638000	BLOWER	DIRECT	1/6	1050	1	CW EOS	208-230	1	60	42	BALL	TEAO	VSUD
S1-02421638700	BLOWER	DIRECT	1/6	1050	1	CW EOS	208-230	1	60	42	BALL	TEAO	VSUD
S1-02412736700	BLOWER	DIRECT	1/5	1075	3	CCW EOS	208-230	1	60	48	BALL	OPEN	HORIZONTAL
S1-02416695700	BLOWER	DIRECT	1/5	1050	2	CW EOS	208-230	1	60	48	BALL	OPEN	VSUDH
S1-02419150700	BLOWER	DIRECT	1/5	1075	3	CW EOS	208-230	1	60	48	BALL	OPEN	HORIZONTAL
S1-02423223700	BLOWER	DIRECT	1/5	1075	4	CW EOS	208-230	1	60	42	BALL	OPEN	VSUDH
S1-02424773000	BLOWER	DIRECT	1/5	1075	3	CCW EOS	208-230	1	60	48	BALL	ODP	HORIZONTAL
S1-02424773700	BLOWER	DIRECT	1/5	1075	3	CCW EOS	208-230	1	60	48	BALL	ODP	HORIZONTAL
S1-52432025000	BLOWER	DIRECT	1/5	1075	VARIABLE	REV	208-230	1	60	48	BALL	OPEN	
S1-02421522000	BLOWER	DIRECT	1/4	1075	3	CCW EOS	208-230	1	60	48	BALL	OPEN	HORIZONTAL
S1-02421526700	BLOWER	DIRECT	1/4	1075	1	CW EOS	208-230	1	60	48	BALL	OPEN	HORIZONTAL
S1-02424151700	BLOWER	DIRECT	1/4	1075	3	REV	208-230	1	60	48	BALL	OPEN	HORIZONTAL
S1-02425982000	BLOWER	DIRECT	1/4	1075	3	CCW EOS	208-230	1	60	48	BALL	OPEN	HORIZONTAL
S1-02427866000	BLOWER	DIRECT	1/4	1075	3	CCW LE	208-230	1	60	48	BALL	SE	
S1-52432025000	BLOWER	DIRECT	1/4	1075	VARIABLE	REV	208-230	1	60	48	BALL	OPEN	
S1-02415643001	BLOWER	DIRECT	1/3	1075	3	CCW	208-230	1	60	48	BALL	OPEN	
S1-02416461700	BLOWER	DIRECT	1/3	825	1	CW EOS	208-230	1	60	48	BALL	OPEN	VSUD
S1-02420357000	BLOWER	DIRECT	1/3	1075	3	CCW EOS	208-230	1	60	48	BALL	OPEN	HORIZONTAL
S1-02421639000	BLOWER	DIRECT	1/3	895	1	CCW EOS	208-230	1	60	48	BALL	ODP	VSD
S1-02421639700	BLOWER	DIRECT	1/3	895	1	CCW EOS	208-230	1	60	48	BALL		VSUD
S1-02424153700	BLOWER	DIRECT	1/3	1075	3	REV	208-230	1	60	48	BALL	OPEN	HORIZONTAL
S1-02424504700	BLOWER	DIRECT	1/3	1075	3	CW EOS	208-230	1	60	48	BALL	OPEN	HORIZONTAL
S1-02424504700	BLOWER	DIRECT	1/3	1075	3	CW EOS	208-230	1	60	48	BALL	OPEN	HORIZONTAL
S1-02424772000	BLOWER	DIRECT	1/3	1075	3	CCW EOS	208-230	1	60	48	BALL	ODP	HORIZONTAL
S1-02424772700	BLOWER	DIRECT	1/3	1075	3	CCW EOS	208-230	1	60	48	BALL	ODP	HORIZONTAL
S1-02425106701	BLOWER	DIRECT	1/3	1075	3	CW EOS	208-230	1	60	48	BALL	OPEN	HORIZONTAL
S1-02425237000	BLOWER	DIRECT	1/3	1075	3	CW EOS	208-230	1	60	48	BALL	ODP	HORIZONTAL
S1-02425237700	BLOWER	DIRECT	1/3	1075	3	CW EOS	208-230	1	60	48	BALL	ODP	HORIZONTAL
S1-02425374700	BLOWER	DIRECT	1/3	1075	3	CW EOS	208-230	1	60	48	BALL		
S1-02425823700	BLOWER	DIRECT	1/3	925	3	CW EOS	208-230	1	60	48	BALL	OPEN	HORIZONTAL
S1-02425952001	BLOWER	DIRECT	1/3	900	3	CCW EOS	208-230	1	60	48	BALL	OPEN	VSD
S1-02425983000	BLOWER	DIRECT	1/3	1075	3	CCW EOS	208-230	1	60	48	BALL	OPEN	VSD
S1-02426086000	BLOWER	DIRECT	1/3	1075	3	CCW EOS	208-230	1	60	48	BALL	OPEN	VSD
S1-02427607000	BLOWER	DIRECT	1/3	925	4	CCW EOS	208-230	1	60	48	BALL	OPEN	HORIZONTAL
S1-02427868000	BLOWER	DIRECT	1/3	1075	3	CCW LE	208-230	1	60	48	BALL	SE	
S1-52432025000	BLOWER	DIRECT	1/3	1075	VARIABLE	REV	208-230	1	60	48	BALL	OPEN	

MOTORS & MOTOR ACCESSORIES

Timesaver Multi-HP PSC Motors

DIRECT DRIVE BLOWER MOTORS

S1-FHM3467



Features:

- Reversible rotation
- Ambient: 40°C
- Open enclosure
- 1/2" x 4.5" shaft (flatted)
- Resilient rings
- Extended thru bolts
- Automatic protector

This Time Saver motor replaces all motors in the cross reference table below.

SOURCE 1 PART NO.	VOLTAGE	RPM	MAX FLA	BEARINGS	LEADS	MLP \$
S1-FHM3467	208/230	1075	4.2	BALL	36"	241.10

SOURCE 1 PART NO.	MAX HP	COOLING	HEATING	CAP (MFD)
S1-FHM3467	3/4	HI	MED-LO	20
	1/2	HI	LO	10
	1/3	MED-HI	LO	10
	1/4	MED-LO	LO	10
	1/5	LO	LO	10

CROSS REFERENCE FOR TIME SAVER™ S1-FHM3467 - BLOWER, DIRECT DRIVE, 1/6-1/2 HP, 208-230V

SOURCE 1 PART NO.	APP	DRIVE	HP	RPM	SPEED	ROTATION	VOLTS	PHASE	HZ	FRAME	BEARING	ENCLOSURE	ORIENT
S1-02412736700	BLOWER	DIRECT	1/5	1075	3	CCWEOS	208-230	1	60	48	BALL	OPEN	HORIZONTAL
S1-02416695700	BLOWER	DIRECT	1/5	1075	2	CWEOS	208-230	1	60	48	BALL	OPEN	VSUDH
S1-02419150700	BLOWER	DIRECT	1/5	1075	3	CWEOS	208-230	1	60	48	BALL	OPEN	HORIZONTAL
S1-02423223700	BLOWER	DIRECT	1/5	1075	4	CWEOS	208-230	1	60	42	BALL	OPEN	VSUDH
S1-02424773000	BLOWER	DIRECT	1/5	1075	3	CCWEOS	208-230	1	60	48	BALL	ODP	HORIZONTAL
S1-02424773700	BLOWER	DIRECT	1/5	1075	3	CCWEOS	208-230	1	60	48	BALL	ODP	HORIZONTAL
S1-52432023000	BLOWER	DIRECT	1/5	1075	VARIABLE	REV	208-230	1	60	48Y	BALL	OPEN	
S1-02421522000	BLOWER	DIRECT	1/4	1075	3	CCWEOS	208-230	1	60	48	BALL	OPEN	HORIZONTAL
S1-02421526700	BLOWER	DIRECT	1/4	1075	1	CWEOS	208-230	1	60	48	BALL	OPEN	HORIZONTAL
S1-02424151700	BLOWER	DIRECT	1/4	1075	3	REV	208-230	1	60	48	BALL	OPEN	HORIZONTAL
S1-02425982000	BLOWER	DIRECT	1/4	1075	3	CCWEOS	208-230	1	60	48	BALL	OPEN	HORIZONTAL
S1-02427866000	BLOWER	DIRECT	1/4	1075	3	CCWLE	208-230	1	60	48	BALL	SE	
S1-52432023000	BLOWER	DIRECT	1/4	1075	VARIABLE	REV	208-230	1	60	48Y	BALL	OPEN	
S1-02415643001	BLOWER	DIRECT	1/3	1075	3	CCW	208-230	1	60	48	BALL	OPEN	
S1-02416461700	BLOWER	DIRECT	1/3	825	1	CWEOS	208-230	1	60	48	BALL	OPEN	VSUD
S1-02420357000	BLOWER	DIRECT	1/3	1075	3	CCWEOS	208-230	1	60	48	BALL	OPEN	HORIZONTAL
S1-02421639000	BLOWER	DIRECT	1/3	895	1	CCWEOS	208-230	1	60	48	BALL	ODP	VSD
S1-02421639700	BLOWER	DIRECT	1/3	895	1	CCWEOS	208-230	1	60	48	BALL		VSUD
S1-02424153700	BLOWER	DIRECT	1/3	1075	3	REV	208-230	1	60	48	BALL	OPEN	HORIZONTAL
S1-02424504700	BLOWER	DIRECT	1/3	1075	3	CWEOS	208-230	1	50	48	BALL	OPEN	HORIZONTAL
S1-02424504700	BLOWER	DIRECT	1/3	1075	3	CWEOS	208-230	1	60	48	BALL	OPEN	HORIZONTAL
S1-02424772000	BLOWER	DIRECT	1/3	1075	3	CCWEOS	208-230	1	60	48	BALL	ODP	HORIZONTAL
S1-02424772700	BLOWER	DIRECT	1/3	1075	3	CCWEOS	208-230	1	60	48	BALL	ODP	HORIZONTAL
S1-02425106701	BLOWER	DIRECT	1/3	1075	3	CWEOS	208-230	1	60	48	BALL	OPEN	HORIZONTAL
S1-02425237000	BLOWER	DIRECT	1/3	1075	3	CWEOS	208-230	1	60	48	BALL	ODP	HORIZONTAL
S1-02425237700	BLOWER	DIRECT	1/3	1075	3	CWEOS	208-230	1	60	48	BALL	ODP	HORIZONTAL
S1-02425374700	BLOWER	DIRECT	1/3	1075	3	CWEOS	208-230	1	60	48	BALL		
S1-02425823700	BLOWER	DIRECT	1/3	925	3	CWEOS	208-230	1	60	48	BALL	OPEN	HORIZONTAL
S1-02425952001	BLOWER	DIRECT	1/3	900	3	CCWEOS	208-230	1	60	48	BALL	OPEN	VSD
S1-02425983000	BLOWER	DIRECT	1/3	1075	3	CCWEOS	208-230	1	60	48	BALL	OPEN	VSD
S1-02426086000	BLOWER	DIRECT	1/3	1075	3	CCWEOS	208-230	1	60	48	BALL	OPEN	VSD
S1-02427607000	BLOWER	DIRECT	1/3	925	4	CCWEOS	208-230	1	60	48	BALL	OPEN	HORIZONTAL
S1-02427868000	BLOWER	DIRECT	1/3	1075	3	CCWLE	208-230	1	60	48	BALL	SE	
S1-52432023000	BLOWER	DIRECT	1/3	1075	VARIABLE	REV	208-230	1	60	48Y	BALL	OPEN	
S1-02421670000	BLOWER	DIRECT	1/3	1050	3	CCWEOS	208-230	1	60	48	BALL	ODP	VSD
S1-02421670700	BLOWER	DIRECT	1/3	1050	3	CCWEOS	208-230	1	60	48	BALL	OPEN	VSD
S1-02424157700	BLOWER	DIRECT	3/4	1075	3	REV	208-230	1	60	48	BALL	OPEN	HORIZONTAL
S1-02424506700	BLOWER	DIRECT	3/4	1075	3	CWEOS	208-230	1	50	48	BALL	OPEN	HORIZONTAL
S1-02424506700	BLOWER	DIRECT	3/4	1075	3	CWEOS	208-230	1	60	48	BALL	OPEN	HORIZONTAL
S1-02425371700	BLOWER	DIRECT	3/4	1075	3	CWEOS	208-230	1	60	48	BALL	OPEN	HORIZONTAL
S1-02425973000	BLOWER	DIRECT	3/4	1075	3	CCWEOS	208-230	1	60	48	BALL	OPEN	HORIZONTAL
S1-02425985000	BLOWER	DIRECT	3/4	1130	3	CCWEOS	208-230	1	60	48	BALL	ODP	HORIZONTAL
S1-02426097000	BLOWER	DIRECT	3/4	1050	3	CCWEOS	208-230	1	60	48	BALL	OE	

Century Electric Motors

5" DIAMETER SINGLE SHAFT OPEN FAN/BLOWER MOTORS

Furnaces - Air Handlers - Fan Coils - Air Conditioning



Features:

- Auto Protector
- Continuous Air Over
- Open Construction
- Permanent Split Capacitor
- 1/2" Dia. Flatted Shaft
- 42 Frame
- 60 Hz
- Sleeve Bearing

OEM Replacements for: Reznor, Luxaire, Armstrong, Payne, Day & Night, Bryant, Bohn, Intertherm, Kodair, Dole, Coleman, Janitrol, Steward Warner, International Heater Etc.

SOURCE 1 PART NO.	HP	RPM	SPEEDS	VOLTS	AMPS	ROTATION	CAPACITOR	DIM. REF.	NOTES	MLP \$
S1-390	1.4-1.5-1.7	1050	3	115	3.7-3.1-2.4	REV	7.5MFD-370V	1	9,26	156.52

Notes: 9. Reversing Plug, 26. Extended thru bolts, shaft end

REF.	BM	C	N	R
1	4.25	10.25	6.00	

CAPACITOR START RESILIENT BASE MOTORS



Features:

- High Start Torque
- 40°C Ambient
- Reversible
- 60 Hz
- 2, 4 and 6 Pole

Applications: Compressors, pumps, conveyors, milking machines, blowers, fans

SOURCE 1 PART NO.	HP	RPM	VOLTS	FULL LOAD AMPS	FRAME	BEARINGS	ENCLOSURE	INSUL. CLASS	OVERLOAD PROTECTOR	MLP \$
S1-RB1074A	3/4	1725	115/208-230	13.0/6.5	56	Ball	ODP	B	Auto	457.67
S1-RB1104AV1	1	1725/1425	115/208-230	14.4/6.6-7.2	56	Ball	Open	B	Auto	495.78

6-1/2" DIAMETER STOCK MOTORS

56 Frame Vertical Condenser Fan Continuous Duty, Air Over



Features:

- Auto Protector
- Class B or F Moisture-Resistant Insulation
- Double Sealed Ball Bearing
- Three Phase
- Quick-Connect Design
- Reversible
- 5/8" Dia. Shaft with both Keyway and Flat
- 60 Hz
- Three Phase - Electrically Reversible

Notes:

163. No keyway, double flat

SOURCE 1 PART NO.	HP	RPM	VOLTS	AMPS	SERVICE FACTOR	FRAME	INSUL. CLASS	AMBIENT °C	ENCLOSURE	MLP \$
S1-H686	1	850	460/200-230	2.0/4.4-4.0	1.00	56Y	B	60	OAO	436.54
S1-H697	1-1/2	1140	460/200-230	2.6/5.4-5.2	1.15	56Y	B	70	TEAO	550.11

CONDENSER FAN MOTOR, PSC

5" Diameter Multifit® Condenser Fan Motors



SOURCE 1 PART NO.	HP	RPM	SPEEDS	VOLTS	AMPS	ROTATION	CAPACITOR	MLP \$
S1-9723F	1/4-1/6	1075	1	208-230	2.0	REV	7.5MFD/370V	221.93

MOTORS & MOTOR ACCESSORIES

Century Electric Motors

OUTDOOR BALL BEARING CONDENSER FAN MOTORS

Three-Phase



Features:

Important: Use amps as well as HP for replacement reference.

- Auto Protector
- Base Mounted
- Ball Bearing
- Capac. Mounted (Single Phase)
- Open Lead End Only
- Reversible
- Service Factor
- 60Hz

SOURCE 1 PART NO.	HP	RPM	VOLTS	MAX AMPS	FRAME	SHAFT	AMBIENT °C	ENCLOSURE	ROTATION	BASE	MLP \$
S1-H685	1	1140	460/200-230	1.9/4.2-3.8	56Y	5/8" KEY & FLAT	60	TEAO	RCC	RCC	495.63

5" DIAMETER SINGLE SHAFT OPEN FAN/BLOWER MOTORS

Furnaces - Air Handlers - Fan Coils - Air Conditioning Motors



OEM Replacements for: Reznor, Luxaire, Armstrong, Payne, Day & Night, Bryant, Bohn, Intertherm, Kodair, Dole, Coleman, Janitrol, Steward Warner, International Heater, etc.

Features:

- Auto Protector
- 1/2" Dia. Flatted Shaft
- Continuous Air Over
- 42 Frame
- Open Construction
- 60 Hz
- Permanent Split Capacitor
- Sleeve Bearing

SOURCE 1 PART NO.	HP	RPM	SPEEDS	VOLTS	AMPS	ROTATION	CAPACITOR	MLP \$
S1-CE-391	1/4-1/5-1/7	1050	3	208-230	1.5-1.2-1.0	REV	7.5MFD/370V	160.64

O.E.M. - DIRECT REPLACEMENT



SOURCE 1 PART NO.	HP	RPM	SPEEDS	VOLTS	AMPS	ROTATION	SHAFT DIA. & LENGTH	MOTOR DIA.	MLP \$
S1-H978	SPL	1140	1	208-230/460/575	5.5/2.8-3.4	REV	5.8" X 4-5/8"	6-1/2"	1981.65

ECM MOTORS

Brushless Direct Drive Blower, ECM



SOURCE 1 PART NO.	HP	RPM	SPEEDS	VOLTS	AMPS	ROTATION	CAPACITOR	MLP \$
S1-6005	0.5	1000-1380	1	115/230	6.7/4.0	CW/CCW	N/A	735.04
S1-6010	1	1000-1380	1	115/230	11.0/6.7	CW/CCW	N/A	952.54

MOTORS & MOTOR ACCESSORIES

FASCO Motors

3-IN-1™ 3.3" DIAMETER PSC MOTOR



Features:

- Easy-to-Read Connection Diagram Attached to White Lead Wire
- Now! Four Studs on Each End
- 40° C Ambient
- Class B Insulation
- 60/50 HZ
- UL and CSA Recognized
- Replaces 1/12, 1/15, 1/20 HP PSC and Low Efficient Shaded Pole Designs
- Direct Drop-in Replacement for walk-in cooler evaporator fans

SOURCE 1 PART NO.	HP	VOLTS	AMPS	RPM	SPEEDS	BM DIM	SHAFT DIA. & LENGTH	ROTATION	WT.	MLP \$
S1-9721	1/12,1/15,1/20	115/208-230	1.1/0.5	1550	1	3.60	5/16 X 3-1/4	REV	4.75	211.21

UNIT BEARING MOTORS



Features:

- Easy-to-Read Connection Diagram Attached to White Lead Wire
- Type: Shaded Pole - Air Over
- 40° C Ambient
- Class B Insulation
- 60/50 HZ
- UL and CSA Recognized
- Fits existing brackets used by GE and Morrill
- Direct Drop-in Replacement for walk-in cooler evaporator fans

SOURCE 1 PART NO.	WATT RATING	VOLTS	AMPS	RPM	SPEEDS	BM DIM	THREADED SHAFT	ROTATION	WT.	MLP \$
S1-RB-D550	2	115	0.24	1550	1	2.37	1/4 - 20	CWLE	2	57.51

REFRIGERATION MOTORS

OEM Replacement Motors



SOURCE 1 PART NO.	DESCRIPTION	REPLACES	TYPE	HP	VOLTS	RPM	SPEED	AMPS	ENCLOSURE	ROT.	BRNG.	MLP \$
S1-RB-D1050	MTR,COND,1/8,1550/1,CWSE,115V	GE/TRANE	PSC	1/8	115	1550	1	1.1	OPEN VENT	CW	SLV	273.25
S1-RB-D1101	MTR,COND,1/20,1500/1,CCWSE,115V	LARKIN COIL	SP	1/20	115	1500	1	1.9	OPEN VENT	CCW	SLV	169.51
S1-RB-D1102	MTR,COND,1/20,1550/1,CWSE,115/230V	WITT	PSC	1/20	115/230	1550	1	.75-.4	OPEN VENT	CW	SLV	245.98
S1-RB-D1103	MTR,COND,1/20,1500/1,CCWSE,208-230V	LARKIN COIL	SP	1/20	208-230	1500	1	1.15	OPEN VENT	CCW	SLV	175.27
S1-RB-D1120	MTR,COND,1/20,1550/1,CWSE,115V	KEEPRITE	SP	1/20	115	1550	1	2.1	OPEN VENT	CW	SLV	212.10
S1-RB-D1121	MTR,COND,1/20,1550/1,CWSE,208-230V	KEEPRITE	SP	1/20	208-230	1550	1	1	OPEN VENT	CW	SLV	219.12
S1-RB-D1124	MTR,COND,1/20,1550/1,CWSE,115V	BOHN	SP	1/20	115	1550	1	2.1	OPEN VENT	CW	SLV	176.76
S1-RB-D1125	MTR,COND,1/12,1550/1,CCWSE,208-230V	BOHN	PSC	1/12	208-230	1550	1	0.5	OPEN VENT	CCW	SLV	199.35
S1-RB-D1126	MTR,COND,1/15,1550/1,CWSE,208-230V	BOHN	SP	1/15	208-230	1550	1	1.1	OPEN VENT	CW	SLV	183.15
S1-RB-D1142	MTR,COND,1/15,1500/1,CWSE,115/230V	MCQUAY	SP	1/15	115/230	1500	1	1.7-.9	OPEN VENT	CW	SLV	244.45
S1-RB-D1144	MTR,COND,1/25-1/35-1/65,1200/3,CWSE,115V	MCQUAY	PSC	1/25-1/35-1/65-	115	1200	3	1.1-9-.6	OPEN VENT	CW	SLV	337.05
S1-RB-D1152	MTR,COND,1/20,1500/1,CWSE,115V	KRAMER/TRENTON	SP	1/20	115	1500	1	1.7	OPEN VENT	CW	SLV	174.23
S1-RB-D1154	MTR,COND,1/20,1550/1,CWSE,230V	KRAMER/TRENTON	SP	1/20	230	1550	1	1	OPEN VENT	CW	SLV	190.32
S1-RB-D1164	MTR,COND,1/25,1550/1,CWSE,115/230V	SINGER	SP	1/25	115/230	1550	1	1.3-.65	TOTALLY ENCL.	CW	SLV	218.04
S1-RB-D1243	MTR,COND,1/20,1550/1,CCWSE,115V	KEEPRITE	PSC	1/20	115	1550	1	0.8	OPEN VENT	CCW	SLV	286.04
S1-RB-D1245	MTR,COND,1/20,1550/1,CCWSE,208-230V	KEEPRITE	PSC	1/20	208-230	1550	1	0.3	OPEN VENT	CCW	SLV	290.75

MOTORS & MOTOR ACCESSORIES

FASCO Motors

BLOWER MOTORS

Draft Inducers



FASCO

SOURCE 1 PART NO.	DESCRIPTION	FASCO MODEL NO.	HP	TYPE	VOLTS	SPEED	AMPS	SE ROT.	MLP \$
S1-RB-A066	BLW ASSEM,VTR,1/30,3000/1,CW,120V	A066	1/30	SP	120	1	1.27	CW	458.81
S1-RB-A079	BLW ASSEM,VTR,1/30,3000/1,CW,120V	A079	1/50	SP	115	1	1.1	CCW	348.72
S1-RB-A134	BLW ASSEM,VTR,1/25,3060/1,CWSE,115V	A134	1/25	SP	115	1	1.5	CW	322.22
S1-RB-A136	BLW ASSEM,VTR,1/20,3450/1,CWSE,115V	A136	1/20	PSC	115	1	0.75	CW	658.09
S1-RB-A138	BLW,ASSEM,VTR,1/70,3000/1,CCW,120V	A138	1/70	SP	120	1	0.70	CCW	417.70
S1-RB-A143	BLW ASSEM,VTR,1/50,3000/1,CWSE,115V	A143	1/50	SP	115	1	0.95	CW	269.09
S1-RB-A157	BLW ASSEM,VTR,1/35,3000/1,CCW,115V	A157	1/35	SP	115	1	1.3	CCW	329.88
S1-RB-A163	BLW ASSEM,VTR,1/20,3400/1,CCWSE,115V	A163	1/20	SP	115	1	1.8	CCW	398.92
S1-RB-A166	BLW ASSEM,VTR,,3200/1,CWSE,115V	A166			115	1	1.4	CW	197.30
S1-RB-A170	BLW ASSEM,VTR,1/25,3400/1,CCWSE,115V	A170	1/25	SP	115	1	2.3	CCW	525.22
S1-RB-A171	BLW ASSEM,VTR,1/25,3450/1,CCWSE,115V	A171	1/25	PSC	115	1	0.7	CCW	536.89
S1-RB-A172	BLW ASSEM,VTR,1/35,3000/1,CWSE,115V	A172	1/35	SP	115	1	1.6	CW	246.20
S1-RB-A173	BLW ASSEM,VTR,1/18,3450/1,CCWSE,115V	A173	1/18	PSC	115	1	0.8	CCW	640.89
S1-RB-A200	BLW ASSEM,VTR,1/30,3000/1,CCWSE,115V	A200	1/30	SP	115	1	1.95	CCW	198.41
S1-RB-D1109	MTR,BLW,1/100,1500/1,CCWSE,115V	D1109	1/100	SP	115	1	0.65	CCW	162.77
S1-RB-D120	MTR,BLW,1/70,1500/1,CWSE,115V	D120	1/70	SP	115	1	0.7	CW	118.84
S1-RB-D121	MTR,BLW,1/70,1500/1,CCWSE,115V	D121	1/70	SP	115	1	0.7	CCW	118.84
S1-RB-D122	MTR,BLW,1/80,1500/1,CWSE,115V	D122	1/80	SP	115	1	0.6	CW	126.25
S1-RB-D123	MTR,BLW,1/80,1500/1,CCWSE,115V	D123	1/80	SP	115	1	0.6	CCW	127.18
S1-RB-D124	MTR,BLW,1/50,1500/1,CWSE,115V	D124	1/50	SP	115	1	0.75	CW	127.18
S1-RB-D125	MTR,BLW,1/50,1500/1,CCWSE,115V	D125	1/50	SP	115	1	0.75	CCW	127.18
S1-RB-D126	MTR,BLW,1/40,1500/1,CWSE,115V	D126	1/40	SP	115	1	1.1	CW	135.59
S1-RB-D132	MTR,BLW,1/20,1500/1,CWSE,115V	D132	1/20	SP	115	1	1.8	CW	116.20
S1-RB-D156	MTR,BLW,1/6,1050/1,CWSE,115V	D156	1/6	SP	115	1	6.6	CW	249.90
S1-RB-D158	MTR,BLW,1/5-1/7,1050/3,CWSE,115V	D158	1/5-1/7	SP	115	3	6.7-5.3-4.7	CW	284.55
S1-RB-D166	MTR,BLW,1/6-1/9,1050,1050/2,CWSE,115V	D166	1/6-1/9	SP	115	2	7.2-3.8	CW	262.14

MOTORS & MOTOR ACCESSORIES

Motor Speed Controls

ECM CONTROLLERS

ICM708



GE 2.3 ECM Controller

Specifications:
Power Supply: 18-30 VAC
RPM Input: 5 VDC
PWM & ON/OFF Outputs: 14 VDC (PWM 80 Hz)

SOURCE 1 PART NO.	DESCRIPTION	MLP \$
S1-ICM708	GE 2.3 ECM CONTROLLER	280.25

ICM711



GE 2.3 ECM Controller

Specifications:
Input:
Power: 18-30 VAC, 60 Hz
Set Speed: Potentiometer, 0-10 VDC
Output:
PWM, On/Off (10mA max)
RPM feedback: 0-10 VDC

SOURCE 1 PART NO.	DESCRIPTION	MLP \$
S1-ICM711	GE 2.3 ECM CONTROLLER	280.25

Motor Speed Controls

ECM CONTROLLERS

ICM709



The ICM709 is a motor speed controlling interface for use with a low voltage thermostat to control the ECM's output.

Specifications:

Input:
Power Supply: 18-30 VAC
RPM Input: 15 VDC

Thermostat Inputs (SPD1-SPD4) 18-30 VAC
Output:
PWM & On/Off Output: 14 VDC (PWM 80 Hz)

SOURCE 1 PART NO.	DESCRIPTION	MLP \$
S1-ICM709	GE 2.3 ECM CONTROLLER	280.25

Capacitors

SINGLE RUN CAPACITORS



Features:

- Made in the USA
- Rated for 60,000 hours
- UL Recognized and meets EIA Standard 456-A
- Storage Temperature: -40°C to 90°C
- Operating Temperature: -40°C to 70°C
- Dual Voltage Applications

SOURCE 1 PART NO.	MFD	VOLTS	CAN STYLE	MLP \$
S1-DT-45050HU	5	370/440V	FLAT	11.22
S1-DT-45075HU	7.5	370/440V	FLAT	13.48
S1-DT-45100HU	10	370/440V	FLAT	14.54
S1-DT-45125HU	12.5	370/440V	FLAT	18.73
S1-DT-45150HU	15	370/440V	FLAT	19.87
S1-DT-45200HU	20	370/440V	FLAT	22.23
S1-DT-45250HU	25	370/440V	FLAT	23.40
S1-DT-45300HU	30	370/440V	FLAT	25.46
S1-DT-45350HU	35	370/440V	FLAT	26.86
S1-DT-45400HU	40	370/440V	FLAT	29.92
S1-DT-45450HU	45	370/440V	FLAT	31.54
S1-DT-45500HU	50	370/440V	FLAT	40.65
S1-DT-45600HU	60	370/440V	FLAT	48.24
S1-DT-45700HU	70	370/440V	FLAT	60.08
S1-DT-45800HU	80	370/440V	FLAT	66.12

MOTORS & MOTOR ACCESSORIES

Capacitors

SINGLE RUN CAPACITORS



Features:

- Continuous duty for single phase AC motors
- Non PCB liquid filled
- 50 & 60 Hz operation
- Tin plated 1/4 x .032 male terminals
- Internally protected by pressure sensitive interrupter device
- Aluminum case with terne plate steel cover

SOURCE 1 PART NO.	MFD	VOLTS	CAN STYLE	MLP \$
S1-CAP37020F	2.0	370	FLAT	3.83
S1-CAP37050R	5.0	370	ROUND	4.22
S1-CAP37075R	7.5	370	ROUND	4.85
S1-CAP37100R	10.0	370	ROUND	5.57
S1-CAP37550R	55.0	370	ROUND	16.64
S1-CAP37700F	70.0	370	FLAT	22.42
S1-CAP37800F	80.0	370	FLAT	25.47
S1-CAP44030F	3.0	440	FLAT	4.04
S1-CAP44040F	4.0	440	FLAT	4.29
S1-CAP44050F	5.0	440	FLAT	4.22
S1-CAP44060F	6.0	440	FLAT	4.66
S1-CAP44075F	7.5	440	FLAT	4.73
S1-CAP44100F	10.0	440	FLAT	5.36
S1-CAP44125F	12.5	440	FLAT	6.38
S1-CAP44150F	15.0	440	FLAT	7.10
S1-CAP44150R	15.0	440	ROUND	6.77
S1-CAP44175F	17.5	440	FLAT	7.54
S1-CAP44200F	20.0	440	FLAT	7.83
S1-CAP44200R	20.0	440	ROUND	7.98
S1-CAP44250F	25.0	440	FLAT	9.18
S1-CAP44250R	25.0	440	ROUND	8.88
S1-CAP44300F	30.0	440	FLAT	10.31
S1-CAP44300R	30.0	440	ROUND	9.69
S1-CAP44350F	35.0	440	FLAT	11.40
S1-CAP44350R	35.0	440	ROUND	10.75
S1-CAP44400F	40.0	440	FLAT	12.31
S1-CAP44400R	40.0	440	ROUND	12.20
S1-CAP44450F	45.0	440	FLAT	14.21
S1-CAP44450R	45.0	440	ROUND	13.30
S1-CAP44500F	50.0	440	FLAT	14.68
S1-CAP44500R	50.0	440	ROUND	14.24
S1-CAP44550F	55.0	440	FLAT	15.30
S1-CAP44600F	60.0	440	FLAT	18.98
S1-CAP44600R	60.0	440	ROUND	16.87
S1-CAP44650R	65.0	440	ROUND	15.67
S1-CAP44700R	70.0	440	ROUND	19.31
S1-CAP44800R	80.0	440	ROUND	21.73

MOTORS & MOTOR ACCESSORIES

Capacitors

DUAL RUN CAPACITORS



- Rated Frequency: 50/60 Hz
- Capacitance Tolerance -5% - +5%
- Permissible Temperature: -25°C - +75°C
- Withstanding Voltage test
- Between Terminals: Rated Voltage X 1.75VAC, 10sec
- Between Terminals and Case: Rated Voltage X 2+1000VAC, 60sec
- Maximum Permissible Voltage: 110% of the rated voltage
- Maximum Permissible Current: 130% of the rated current
- UL Recognized Components; CSA22.2 No190
- Oil Filled; Non PCB
- Quick Connect Terminal

SOURCE 1 PART NO.	MFD		VOLTS	CAN STYLE	MLP \$
	COMPR	FAN			
S1-CAP3704025DR	25.0	4.0	370	ROUND	12.39
S1-CAP3705015DF	15.0	5.0	370	FLAT	13.58
S1-CAP3705020DF	20.0	5.0	370	FLAT	14.17
S1-CAP3705020DR	20.0	5.0	370	ROUND	11.01
S1-CAP3705080DR	80.0	5.0	370	ROUND	25.86
S1-CAP3707530DF	30.0	7.5	370	FLAT	15.58
S1-CAP3707545DF	45.0	7.5	370	FLAT	20.82
S1-CAP3707555DF	55.0	7.5	370	FLAT	21.71
S1-CAP3710015DF	15.0	10.0	370	FLAT	14.42
S1-CAP3710025DF	25.0	10.0	370	FLAT	13.94
S1-CAP3715020DF	20.0	15.0	370	FLAT	13.91
S1-CAP4403030DR	30.0	3.0	440	ROUND	10.20
S1-CAP4403035DR	35.0	3.0	440	ROUND	11.94
S1-CAP4403040DR	40.0	3.0	440	ROUND	13.08
S1-CAP4403045DR	45.0	3.0	440	ROUND	14.32
S1-CAP4405025DF	25.0	5.0	440	FLAT	12.34
S1-CAP4405025DR	25.0	5.0	440	ROUND	9.32
S1-CAP4405030DF	30.0	5.0	440	FLAT	12.79
S1-CAP4405030DR	30.0	5.0	440	ROUND	10.13
S1-CAP4405035DF	35.0	5.0	440	FLAT	12.82
S1-CAP4405035DR	35.0	5.0	440	ROUND	11.26
S1-CAP4405040DF	40.0	5.0	440	FLAT	13.70
S1-CAP4405040DR	40.0	5.0	440	ROUND	12.28
S1-CAP4405045DF	45.0	5.0	440	FLAT	15.37
S1-CAP4405045DR	45.0	5.0	440	ROUND	13.84
S1-CAP4405050DR	50.0	5.0	440	ROUND	14.72
S1-CAP4405055DR	55.0	5.0	440	ROUND	15.88
S1-CAP4405060DR	60.0	5.0	440	ROUND	16.50
S1-CAP4407530DR	30.0	7.5	440	ROUND	11.36
S1-CAP4407535DF	35.0	7.5	440	FLAT	13.32
S1-CAP4407535DR	35.0	7.5	440	ROUND	12.50
S1-CAP4407540DF	40.0	7.5	440	FLAT	14.86
S1-CAP4407545DR	45.0	7.5	440	ROUND	14.86
S1-CAP4407550DR	50.0	7.5	440	ROUND	15.44
S1-CAP4407555DR	55.0	7.5	440	ROUND	17.96
S1-CAP4407560DR	60.0	7.5	440	ROUND	18.43
S1-CAP4407580DR	80.0	7.5	440	ROUND	25.17
S1-CAP4410040DR	40.0	10.0	440	ROUND	15.44
S1-CAP4410045DR	45.0	10.0	440	ROUND	16.04
S1-CAP4410055DR	55.0	10.0	440	ROUND	18.09

MOTORS & MOTOR ACCESSORIES

Capacitors

DUAL RUN CAPACITORS



Features:

- Made in the USA
- Rated for 60,000 hours
- UL Recognized and meets EIA Standard 456-A
- Storage Temperature: -40°C to 90°C
- Operating Temperature: -40°
- Dual Voltage Applications

SOURCE 1 PART NO.	MFD	VOLTS	CAN STYLE	MLP \$
S1-DT-4JR0525U	25 / 5	370/440V	ROUND	29.44
S1-DT-4JR0530U	30 / 5	370/440V	ROUND	30.13
S1-DT-4JR0535U	35 / 5	370/440V	ROUND	32.57
S1-DT-4JR0540U	40 / 5	370/440V	ROUND	36.20
S1-DT-4JR0545U	45 / 5	370/440V	ROUND	38.56
S1-DT-4JR0550U	50 / 5	370/440V	ROUND	40.18
S1-DT-4JR0555U	55 / 5	370/440V	ROUND	42.05
S1-DT-4JR0560U	60 / 5	370/440V	ROUND	43.23
S1-DT-4JR0580U	80 / 5	440V	ROUND	54.81
S1-DT-4JR7530U	30 / 7.5	440V	ROUND	34.39
S1-DT-4JR7535U	35 / 7.5	440V	ROUND	35.50
S1-DT-4JR7540U	40 / 7.5	370/440V	ROUND	37.38
S1-DT-4JR7545U	45 / 7.5	370/440V	ROUND	39.71
S1-DT-4JR7550U	50 / 7.5	440V	ROUND	45.73
S1-DT-4JR7555U	55 / 7.5	440V	ROUND	47.28
S1-DT-4JR7560U	60 / 7.5	440V	ROUND	48.42

START CAPACITORS



Features:

- Molded plastic case
- Designed for 20 starts per hour duty cycle
- 50/60 Hz operation
- 4 x .032 male push on terminals
- 15,000 OHM / 2 watt resistor

SOURCE 1 PART NO.	MFD	VOLTS	CAN STYLE	DIMENSIONS		MLP \$
				D	H	
S1-02425071700	145-175	250	ROUND	2.06	4.38	12.29
S1-02425075700	161-193	250	ROUND	2.06	4.38	17.88
S1-02426023000	297-356	330	ROUND	2.06	4.38	22.99
S1-02425191700	88-108	330	ROUND	2.06	4.38	12.58
S1-02425215700	189-227	330	ROUND	2.06	4.38	35.61
S1-02425390700	270-324	330	ROUND	2.56	4.38	29.21

TURBO CAPACITORS

Turbo® 200



- A. TurboTester™** - Simultaneously test and display MFD values for fan and compressor.
- B. The Original Turbo™ 200** - Technicians can now replace any one of the more than 200 dual capacitors used for HVAC and maintenance work.
- C. Turbo™ 200 MINI** - A permanent replacement for up to 14 popular "fan-sized" values—2.5 mfd to 12.5 mfd
- D. Turbo™ 200X** - Replace any one of the higher range of capacitors used in scroll compressors and higher efficiency A/C units requiring duals such as 70/5 to as high as 90/7.5.
- E. Turbolytic™ 50** - the world's first universal "Motor-Start" capacitor—can replace any one of the most popular values and voltages. For your safety and performance, the Turbo@200 series has been tested and approved to the highest certification level of UL Standard 810; 10,000 AFC; PROTECTED. (As required for all "original equipment" motor-run capacitors.)

SOURCE 1 PART NO.	DESCRIPTION	QTY. PER CASE	MLP \$
S1-TURBO200	CAP,RUN,2.5-67.5 MFD,TURBO 200	20	166.65
S1-TURBO200MINI	CAP,RUN,2.5-12.5 MFD,TURBO 200 MINI	50	24.98
S1-TURBO200X	CAP,RUN,70/5-90/7.5 MFD,TURBO 200X	16	216.02

*Price per piece

MOTORS & MOTOR ACCESSORIES

Fan Blades

PROPELLER FANS

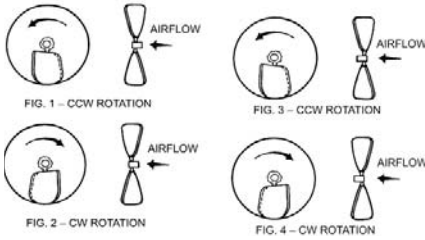

Features:

- Rotationally balanced
- 1/4 - 28 or 5/16 - 24 sq. hd. set screw (torque to 100 in. lb.)
- Steel hub and spider construction with corrosion protection
- (250 HR. of 5% salt spray)
- Steel blades are corrosion protected (250 HR. of 5% salt spray)
- Air Moving and Conditioning
- Association (AMCA) rated

SOURCE 1 PART NO.	NOM DIA.	QTY. PER CASE			ROTATION FACING AIR DISCH.	HUB				MLP \$
		NUMBER OF	PITCH (DEG)	TYPE		NOM BORE	LOCATION	FIG NO.	NO. OF SET SCREWS	
S1-02619367000	12"	4	36	ALUM	CCW	1/2	INTAKE	1	1	55.59
S1-02619368000	12"	4	36	ALUM	CW	1/2	INTAKE	2	1	53.90
S1-02619369000	16"	4	43	ALUM	CCW	1/2	INTAKE	1	1	68.11
S1-02619370000	16"	4	43	ALUM	CW	1/2	INTAKE	2	1	68.32
S1-02619372000	14"	4	40	ALUM	CW	1/2	INTAKE	2	1	68.70

Blower Wheels

DOUBLE INLET SINGLE HUB

Concave Center Plate



Features:

- Concentric to bore within .062 total indicator runout (TIR)
- Balanced for vibration free operation
- (1) set screw (except as noted)
- Concave center plate
- Max RPM = 1750

NOTE: Torque set screw(s) to 14 to 20 ft. lbs.

SOURCE 1 PART NO.	MFG	MFG PART NO	NOMINAL		DIMENSIONS		NOM. BORE DIA	NO OF BLADES	ROTATION FACING HUB	MATERIAL TYPE	MLP \$
			DIA.	WIDTH	D	W					
S1-02619654012	LAU	026941-25	11	10	12.25	10.62	.500	53	CW	PTD STL	249.03

* (2) Set screws, 90° apart.

Convex Center Plate



Features:

- Concentric to bore within .062 total indicator runout (TIR)
- Balanced for vibration free operation
- (1) set screw (except as noted)
- Convex center plate
- Max RPM = 1750

NOTE: Torque set screw(s) to 14 to 20 ft. lbs.

SOURCE 1 PART NO.	MFG	MFG PART NO	NOMINAL		DIMENSIONS		NOM. BORE DIA	NO OF BLADES	ROTATION FACING HUB	MATERIAL TYPE	MLP \$
			DIA.	WIDTH	D	W					
S1-02619654014	MORRISON	03-55041	11	10	11.93	10.68	.500	54	CW	PTD STL	163.46

* (2) Set screws, 90° apart.

2-Blade Propellers

LAU PROPELLERS - OEM-STYLE WITH FIXED HUB

Application: Condensers

High quality aluminum blades with corrosion-resistant center spiders



SOURCE 1 PART NO.	DESCRIPTION	DIAMETER	PITCH	ROTATION	HUB LOCATION	BORE SIZE	QTY PACK	MLP \$
S1-LA-6130470001	FAN,PROP,14",CW,2-32	14	32°	CW	Discharge	1/2	2	46.94
S1-LA-6130460001	FAN,PROP,14",CCW,2-36	14	36°	CCW	Intake	1/2	2	32.37
S1-LA-6141660001	FAN,PROP,14",CW,2-36,1/2" DISCH HUB	14	36°	CW	Discharge	1/2	2	34.71
S1-LA-6130490001	FAN,PROP,18",CCW,2-19	18	19°	CCW	Intake	1/2	2	39.92
S1-LA-6130500001	FAN,PROP,18",CW,2-24	18	24°	CW	Intake	1/2	2	41.31
S1-LA-60772501	FAN,PROP,18",CCW,2-28, 1/2" INTAKE HUB	18	28°	CCW	Intake	1/2	2	42.70
S1-LA-6130510001	FAN,PROP,18",CW,2-29	18	29°	CW	Intake	1/2	2	39.92
S1-LA-60652101	FAN,PROP,18",CCW,2-33,1/2" INTAKE HUB	18	33°	CCW	Intake	1/2	2	46.61
S1-LA-6130520001	FAN,PROP,18",CW,2-36	18	36°	CW	Intake	1/2	2	39.92
S1-LA-6130530001	FAN,PROP,20",CW,2-23	20	23°	CCW	Intake	1/2	2	40.60
S1-LA-6130540001	FAN,PROP,20",CW,2-26	20	25°	CCW	Intake	1/2	2	40.60
S1-LA-60772601	FAN,PROP,20",CCW,2-28,1/2" INTAKE HUB	20	28°	CCW	Intake	1/2	2	43.48
S1-LA-6130560001	FAN,PROP,20",CW,2-28	20	28°	CW	Intake	1/2	2	42.80
S1-LA-6130550001	FAN,PROP,20",CCW,2-34	20	34°	CCW	Intake	1/2	2	40.60
S1-LA-60772701	FAN,PROP,22",CCW,2-16,1/2" INTAKE HUB	22	16°	CCW	Intake	1/2	2	50.47
S1-LA-6128990001	FAN,PROP,22",CCW,2-21,1/2" INTAKE HUB	22	21°	CCW	Intake	1/2	2	45.55
S1-LA-60814201	FAN,PROP,22",CCW,2-27,1/2" INTAKE HUB	22	27°	CCW	Intake	1/2	2	57.56
S1-LA-6130570001	FAN,PROP,24",CCW,2-19	24	19°	CCW	Intake	1/2	2	47.21
S1-LA-61040201	FAN,PROP,24",CCW,2-22°, 1/2" INTAKE HUB	24	22°	CCW	Intake	1/2	2	47.21
S1-LA-6130580001	FAN,PROP,24",CCW,2-24	24	24°	CCW	Intake	1/2	2	48.44
S1-LA-60772801	FAN,PROP,24",CCW,2-27,1/2" INTAKE HUB	24	27°	CCW	Intake	1/2	2	50.54

3-Blade Propellers

LAU PROPELLERS - HEAVY DUTY CONDENSER STYLE

Application: Condensing Units, Building & Agricultural Ventilation Fans

High strength aluminum blades with corrosion-resistant center spiders



SOURCE 1 PART NO.	DESCRIPTION	DIAMETER	PITCH	ROTATION	HUB LOCATION	BORE SIZE	QTY PACK	MLP \$
S1-LA-6129770001	FAN,PROP,10",CW,3-23	10	23°	CW	Interchangeable		2	40.30
S1-LA-6129760001	FAN,PROP,10",CCW,3-23	10	23°	CCW	Interchangeable		2	40.30
S1-LA-60716101	FAN,PROP,12",CW,3-19	12	19°	CW	Interchangeable		2	38.13
S1-LA-60716201	FAN,PROP,12",CCW,3-19	12	19°	CCW	Interchangeable		2	38.13
S1-LA-60716301	FAN,PROP,12",CW,3-23	12	23°	CW	Interchangeable		2	38.13
S1-LA-60716401	FAN,PROP,12",CCW,3-23	12	23°	CCW	Interchangeable		2	38.13
S1-LA-6129790001	FAN,PROP,12",CW,3-27	12	27°	CW	Interchangeable		2	41.50
S1-LA-6129780001	FAN,PROP,12",CCW,3-27	12	27°	CCW	Interchangeable		2	41.50
S1-LA-60998901	FAN,PROP,14",CW,3-19,5/16" INTAKE HUB	14	19°	CW	Intake	5/16	2	57.43
S1-LA-60716501	FAN,PROP,14",CW,3-23	14	23°	CW	Interchangeable		2	43.30
S1-LA-60716601	FAN,PROP,14",CCW,3-23	14	23°	CCW	Interchangeable		2	43.30
S1-LA-60716701	FAN,PROP,14",CW,3-27	14	27°	CW	Interchangeable		2	43.30
S1-LA-60716801	FAN,PROP,14",CCW,3-27	14	27°	CCW	Interchangeable		2	45.69
S1-LA-60716901	FAN,PROP,16",CW,3-19	16	19°	CW	Interchangeable		2	52.15
S1-LA-60717001	FAN,PROP,16",CCW,3-19	16	19°	CCW	Interchangeable		2	52.15
S1-LA-60717101	FAN,PROP,16",CW,3-23	16	23°	CW	Interchangeable		2	47.81
S1-LA-60717201	FAN,PROP,16",CCW,3-23	16	23°	CCW	Interchangeable		2	52.15
S1-LA-6129810001	FAN,PROP,16",CW,3-27	16	27°	CW	Interchangeable		2	59.74
S1-LA-6129800001	FAN,PROP,16",CCW,3-27	16	27°	CCW	Interchangeable		2	59.74
S1-LA-6130590001	FAN,PROP,18",CW,3-19,1/2" DISCH HUB	18	19°	CW	Interchangeable		2	60.41
S1-LA-6130600001	FAN,PROP,18",CCW,3-22,1/2" BORE	18	22°	CCW	Intake	1/2	2	60.41
S1-LA-60556001	FAN,PROP,18",CCW,3-23, FREE AIR TYPE	18	23°	CCW	Interchangeable		2	57.11

3-Blade Propellers

LAU PROPELLERS - HEAVY DUTY CONDENSER STYLE

Application: Condensing Units, Building & Agricultural Ventilation Fans

High strength aluminum blades with corrosion-resistant center spiders

SOURCE 1 PART NO.	DESCRIPTION	DIAMETER	PITCH	ROTATION	HUB LOCATION	BORE SIZE	QTY PACK	MLP \$
S1-LA-6130610001	FAN,PROP,18",CW,3-26,1/2" DISCH HUB	18	26°	CW	DISCHARGE	1/2	2	60.41
S1-LA-60556101	FAN,PROP,18",CW,3-27	18	27°	CW	INTERCHANGEABLE		2	51.07
S1-LA-60556201	FAN,PROP,18",CCW,3-27	18	27°	CCW	INTERCHANGEABLE		2	57.59
S1-LA-60556301	FAN,PROP,18",CW,3-30	18	30°	CW	INTERCHANGEABLE		2	60.84
S1-LA-60556401	FAN,PROP,18",CCW,3-30	18	30°	CCW	INTERCHANGEABLE		2	55.72
S1-LA-60556501	FAN,PROP,18",CW,3-33	18	33°	CW	INTERCHANGEABLE		2	60.84
S1-LA-60556601	FAN,PROP,18",CCW,3-33	18	33°	CCW	INTERCHANGEABLE		2	55.72
S1-LA-6130620001	FAN,PROP,18",CCW,3-35,1/2" BORE	18	35°	CCW	INTAKE	1/2	2	60.41
S1-LA-60870301	FAN,PROP,20",CW,3-21,1/2" DISCH HUB	20	21°	CW	DISCHARGE	1/2	2	63.30
S1-LA-6129830001	FAN,PROP,20",CW,3-24	20	24°	CW	INTERCHANGEABLE		2	46.94
S1-LA-6129820001	FAN,PROP,20",CCW,3-24	20	24°	CCW	INTERCHANGEABLE		2	46.94
S1-LA-60999001	FAN,PROP,20",CCW,3-25,1/2" INTAKE HUB	20	25°	CCW	INTAKE	1/2	2	46.94
S1-LA-60556701	FAN,PROP,20",CW,3-27	20	27°	CW	INTERCHANGEABLE		2	62.03
S1-LA-60556801	FAN,PROP,20",CCW,3-27	20	27°	CCW	INTERCHANGEABLE		2	62.03
S1-LA-60556901	FAN,PROP,20",CW,3-30	20	30°	CW	INTERCHANGEABLE		2	65.39
S1-LA-60557001	FAN,PROP,20",CCW,3-30	20	30°	CCW	INTERCHANGEABLE		2	62.03
S1-LA-6130630001	FAN,PROP,20",CW,3-31,1/2" DISCH HUB	20	31°	CW	DISCHARGE	1/2	2	57.21
S1-LA-60557101	FAN,PROP,20",CW,3-33	20	33°	CW	INTERCHANGEABLE		2	62.03
S1-LA-60557201	FAN,PROP,20",CCW,3-33	20	33°	CCW	INTERCHANGEABLE		2	62.03
S1-LA-6129570001	FAN,PROP,22",CW,3-20,1/2" INTAKE HUB	22	20°	CW	INTAKE	1/2	2	52.34
S1-LA-6130640001	FAN,PROP,22",CW,3-24,1/2" INTAKE HUB	22	24°	CW	INTAKE	1/2	2	60.89
S1-LA-60557301	FAN,PROP,22",CW,3-27	22	27°	CW	INTERCHANGEABLE		2	79.63
S1-LA-60557401	FAN,PROP,22",CCW,3-27	22	27°	CCW	INTERCHANGEABLE		2	75.53
S1-LA-6130650001	FAN,PROP,22",CW,3-28,1/2" INTAKE HUB	22	28°	CW	INTAKE	1/2	2	60.89
S1-LA-6129850001	FAN,PROP,22",CW,3-30	22	30°	CW	INTERCHANGEABLE		2	86.52
S1-LA-6129840001	FAN,PROP,22",CCW,3-30	22	30°	CCW	INTERCHANGEABLE		2	86.52
S1-LA-60557501	FAN,PROP,22",CW,3-33	22	33°	CW	INTERCHANGEABLE		2	75.53
S1-LA-60557601	FAN,PROP,22",CCW,3-33	22	33°	CCW	INTERCHANGEABLE		2	79.63
S1-LA-6129870001	FAN,PROP,22",CW,3-35	22	35°	CW	INTERCHANGEABLE		2	82.06
S1-LA-6129860001	FAN,PROP,22",CCW,3-35	22	35°	CCW	INTERCHANGEABLE		2	82.06
S1-LA-6131430001	FAN,PROP,24",CW,3-22,1/2" INTAKE HUB	24	22°	CW	INTAKE	1/2	2	66.81
S1-LA-60557701	FAN,PROP,24",CW,3-27	24	27°	CW	INTERCHANGEABLE		2	84.96
S1-LA-60557801	FAN,PROP,24",CCW,3-27	24	27°	CCW	INTERCHANGEABLE		2	80.56
S1-LA-6128230001	FAN,PROP,24",CW,3-30,1/2" INTAKE HUB	24	30°	CW	INTAKE	1/2	2	87.47
S1-LA-60557901	FAN,PROP,24",CW,3-33	24	33°	CW	INTERCHANGEABLE		2	84.96
S1-LA-60558001	FAN,PROP,24",CCW,3-33	24	33°	CCW	INTERCHANGEABLE		2	80.56
S1-LA-61046601	FAN,PROP,26",CW,3-26,1/2" DISCH HUB	26	26°	CW	DISCHARGE	1/2	1	65.62
S1-LA-6129890001	FAN,PROP,26",CW,3-26	26	26°	CW	INTERCHANGEABLE		1	93.20
S1-LA-6129880001	FAN,PROP,26",CCW,3-26	26	26°	CCW	INTERCHANGEABLE		1	93.20
S1-LA-6129910001	FAN,PROP,26",CW,3-33	26	33°	CW	INTERCHANGEABLE		1	93.20
S1-LA-6129900001	FAN,PROP,26",CCW,3-33	26	33°	CCW	INTERCHANGEABLE		1	93.20
S1-LA-6130660001	FAN,PROP,26",CW,3-37,1/2" INTAKE HUB	26	37°	CW	INTAKE	1/2	1	64.35
S1-LA-6129920001	FAN,PROP,30",CCW,3-27	30	27°	CCW	INTERCHANGEABLE		1	94.67
S1-LA-6129930001	FAN,PROP,30",CW,3-27	30	27°	CW	INTERCHANGEABLE		1	94.67
S1-LA-6129940001	FAN,PROP,30",CCW,3-33	30	33°	CCW	INTERCHANGEABLE		1	94.67
S1-LA-6129950001	FAN,PROP,30",CW,3-33	30	33°	CW	INTERCHANGEABLE		1	94.67

MOTORS & MOTOR ACCESSORIES

4-Blade Propellers

LAU PROPELLERS - HEAVY DUTY CONDENSER STYLE

Application: Condensing Units, Building & Agricultural Ventilation Fans

High strength aluminum blades with corrosion-resistant center spiders



SOURCE 1 PART NO.	DESCRIPTION	DIAMETER	PITCH	ROTATION	HUB LOCATION	BORE SIZE	MLP \$
S1-LA-6129970001	FAN,PROP,10",CW,4-16	10	16°	CW	INTERCHANGEABLE		39.10
S1-LA-6129960001	FAN,PROP,10",CCW,4-16	10	16°	CCW	INTERCHANGEABLE		39.10
S1-LA-60717301	FAN,PROP,10",CW,4-19	10	19°	CW	INTERCHANGEABLE		35.99
S1-LA-60717401	FAN,PROP,10",CCW,4-19	10	19°	CCW	INTERCHANGEABLE		35.99
S1-LA-60717501	FAN,PROP,10",CW,4-23	10	23°	CW	INTERCHANGEABLE		35.99
S1-LA-60717601	FAN,PROP,10",CCW,4-23	10	23°	CCW	INTERCHANGEABLE		35.99
S1-LA-60717701	FAN,PROP,10",CW,4-27	10	27°	CW	INTERCHANGEABLE		35.99
S1-LA-60717801	FAN,PROP,10",CCW,4-27	10	27°	CCW	INTERCHANGEABLE		35.99
S1-LA-60759901	FAN,PROP,10",CW,4-33	10	33°	CW	INTERCHANGEABLE		35.99
S1-LA-60760001	FAN,PROP,10",CCW,4-33	10	33°	CCW	INTERCHANGEABLE		35.99
S1-LA-6129990001	FAN,PROP,12",CW,4-16	12	16°	CW	INTERCHANGEABLE		41.28
S1-LA-6129980001	FAN,PROP,12",CCW,4-16	12	16°	CCW	INTERCHANGEABLE		41.28
S1-LA-60717901	FAN,PROP,12",CW,4-19	12	19°	CW	INTERCHANGEABLE		38.05
S1-LA-60718001	FAN,PROP,12",CCW,4-19	12	19°	CCW	INTERCHANGEABLE		38.05
S1-LA-60718101	FAN,PROP,12",CW,4-23	12	23°	CW	INTERCHANGEABLE		38.05
S1-LA-60718201	FAN,PROP,12",CCW,4-23	12	23°	CCW	INTERCHANGEABLE		38.05
S1-LA-60718301	FAN,PROP,12",CW,4-27	12	27°	CW	INTERCHANGEABLE		38.05
S1-LA-60718401	FAN,PROP,12",CCW,4-27	12	27°	CCW	INTERCHANGEABLE		38.05
S1-LA-60760101	FAN,PROP,12",CW,4-33	12	33°	CW	INTERCHANGEABLE		34.98
S1-LA-60760201	FAN,PROP,12",CCW,4-33	12	33°	CCW	INTERCHANGEABLE		38.05
S1-LA-6130010001	FAN,PROP,14",CW,4-16	14	16°	CW	INTERCHANGEABLE		48.78
S1-LA-6130000001	FAN,PROP,14",CCW,4-16	14	16°	CCW	INTERCHANGEABLE		48.78
S1-LA-60718501	FAN,PROP,14",CW,4-19	14	19°	CW	INTERCHANGEABLE		44.95
S1-LA-60718601	FAN,PROP,14",CCW,4-19	14	19°	CCW	INTERCHANGEABLE		44.95
S1-LA-60718701	FAN,PROP,14",CW,4-23	14	23°	CW	INTERCHANGEABLE		44.95
S1-LA-60718801	FAN,PROP,14",CCW,4-23	14	23°	CCW	INTERCHANGEABLE		44.95
S1-LA-60718901	FAN,PROP,14",CW,4-27	14	27°	CW	INTERCHANGEABLE		47.39
S1-LA-60719001	FAN,PROP,14",CCW,4-27	14	27°	CCW	INTERCHANGEABLE		44.95
S1-LA-60760301	FAN,PROP,14",CW,4-33	14	33°	CW	INTERCHANGEABLE		49.09
S1-LA-60760401	FAN,PROP,14",CCW,4-33	14	33°	CCW	INTERCHANGEABLE		44.95
S1-LA-60719101	FAN,PROP,16",CW,4-19	16	19°	CW	INTERCHANGEABLE		57.45
S1-LA-60719201	FAN,PROP,16",CCW,4-19	16	19°	CCW	INTERCHANGEABLE		57.45
S1-LA-60719301	FAN,PROP,16",CW,4-23	16	23°	CW	INTERCHANGEABLE		52.64
S1-LA-60719401	FAN,PROP,16",CCW,4-23	16	23°	CCW	INTERCHANGEABLE		57.45
S1-LA-60719501	FAN,PROP,16",CW,4-27	16	27°	CW	INTERCHANGEABLE		57.45
S1-LA-60719601	FAN,PROP,16",CCW,4-27	16	27°	CCW	INTERCHANGEABLE		52.64
S1-LA-60760501	FAN,PROP,16",CW,4-33	16	33°	CW	INTERCHANGEABLE		57.45
S1-LA-60760601	FAN,PROP,16",CCW,4-33	16	33°	CCW	INTERCHANGEABLE		52.64
S1-LA-6130030001	FAN,PROP,18",CW,4-16	18	16°	CW	INTERCHANGEABLE		56.40
S1-LA-6130020001	FAN,PROP,18",CCW,4-16	18	16°	CCW	INTERCHANGEABLE		56.40
S1-LA-6130050001	FAN,PROP,18",CW,4-19	18	19°	CW	INTERCHANGEABLE		56.40
S1-LA-6130040001	FAN,PROP,18",CCW,4-19	18	19°	CCW	INTERCHANGEABLE		56.40
S1-LA-60800201	FAN,PROP,18",CW,4-23	18	23°	CW	INTERCHANGEABLE		70.45
S1-LA-60800301	FAN,PROP,18",CCW,4-23	18	23°	CCW	INTERCHANGEABLE		68.10
S1-LA-60558101	FAN,PROP,18",CW,4-27	18	27°	CW	INTERCHANGEABLE		68.10
S1-LA-60558201	FAN,PROP,18",CCW,4-27	18	27°	CCW	INTERCHANGEABLE		62.59
S1-LA-60558301	FAN,PROP,18",CW,4-30	18	30°	CW	INTERCHANGEABLE		68.10
S1-LA-60558401	FAN,PROP,18",CCW,4-30	18	30°	CCW	INTERCHANGEABLE		74.39
S1-LA-60558501	FAN,PROP,18",CW,4-33	18	33°	CW	INTERCHANGEABLE		62.59
S1-LA-60558601	FAN,PROP,18",CCW,4-33	18	33°	CCW	INTERCHANGEABLE		62.59
S1-LA-6130070001	FAN,PROP,20",CW,4-14	20	14°	CW	INTERCHANGEABLE		79.62
S1-LA-6130060001	FAN,PROP,20",CCW,4-14	20	14°	CCW	INTERCHANGEABLE		79.62
S1-LA-6130090001	FAN,PROP,20",CW,4-17	20	17°	CW	INTERCHANGEABLE		79.62
S1-LA-6130080001	FAN,PROP,20",CCW,4-17	20	17°	CCW	INTERCHANGEABLE		79.62
S1-LA-6130110001	FAN,PROP,20",CW,4-19	20	19°	CW	INTERCHANGEABLE		79.62
S1-LA-6130100001	FAN,PROP,20",CCW,4-19	20	19°	CCW	INTERCHANGEABLE		79.62
S1-LA-6130670001	FAN,PROP,20",CW,4-20,1/2" DISCHARGE HUB	20	20°	CW	DISCHARGE	1/2	65.18
S1-LA-60800401	FAN,PROP,20",CW,4-23	20	23°	CW	INTERCHANGEABLE		73.32
S1-LA-60800501	FAN,PROP,20",CCW,4-23	20	23°	CCW	INTERCHANGEABLE		73.32
S1-LA-60558701	FAN,PROP,20",CW,4-27	20	27°	CW	INTERCHANGEABLE		73.32

MOTORS &
MOTOR ACCESSORIES

4-Blade Propellers

LAU PROPELLERS - HEAVY DUTY CONDENSER STYLE

Application: Condensing Units, Building & Agricultural Ventilation Fans

High strength aluminum blades with corrosion-resistant center spiders

SOURCE 1 PART NO.	DESCRIPTION	DIAMETER	PITCH	ROTATION	HUB LOCATION	BORE SIZE	MLP \$
S1-LA-60558801	FAN,PROP,20",CCW,4-27	20	27°	CCW	INTERCHANGEABLE		67.35
S1-LA-60943601	FAN,PROP,20",CW,4-29,1/2" DISCH HUB	20	29°	CW	DISCHARGE	1/2	74.37
S1-LA-60558901	FAN,PROP,20",CW,4-30	20	30°	CW	INTERCHANGEABLE		77.31
S1-LA-60559001	FAN,PROP,20",CCW,4-30	20	30°	CCW	INTERCHANGEABLE		77.31
S1-LA-60559101	FAN,PROP,20",CW,4-33	20	33°	CW	INTERCHANGEABLE		67.35
S1-LA-60559201	FAN,PROP,20",CCW,4-33	20	33°	CCW	INTERCHANGEABLE		73.32
S1-LA-6130680001	FAN,PROP,20",CW,4-36,1/2" INTAKE HUB	20	36°	CW	INTAKE	1/2	64.13
S1-LA-60804101	FAN,PROP,22",CW,4-23	22	23°	CW	INTERCHANGEABLE		85.32
S1-LA-60804201	FAN,PROP,22",CCW,4-23	22	23°	CCW	INTERCHANGEABLE		85.32
S1-LA-6130690001	FAN,PROP,22",CW,4-24,1/2" DISCH HUB	22	24°	CW	DISCHARGE	1/2	65.59
S1-LA-6130700001	FAN,PROP,22",CW,4-26,1/2" INTAKE HUB	22	26°	CW	INTAKE	1/2	66.41
S1-LA-60559301	FAN,PROP,22",CW,4-27	22	27°	CW	INTERCHANGEABLE		90.06
S1-LA-60559401	FAN,PROP,22",CCW,4-27	22	27°	CCW	INTERCHANGEABLE		90.06
S1-LA-60841201	FAN,PROP,22",CW,4-30,1/2" DISCH HUB	22	30°	CW	DISCHARGE	1/2	97.93
S1-LA-60559501	FAN,PROP,22",CW,4-33	22	33°	CW	INTERCHANGEABLE		78.32
S1-LA-60559601	FAN,PROP,22",CCW,4-33	22	33°	CCW	INTERCHANGEABLE		85.32
S1-LA-6130130001	FAN,PROP,22",CW,4-36	22	35°	CW	INTERCHANGEABLE		92.52
S1-LA-6130120001	FAN,PROP,22",CCW,4-36	22	35°	CCW	INTERCHANGEABLE		92.52
S1-LA-6130150001	FAN,PROP,24",CW,4-13	24	13°	CW	INTERCHANGEABLE		97.56
S1-LA-6130140001	FAN,PROP,24",CCW,4-13	24	13°	CCW	INTERCHANGEABLE		97.56
S1-LA-6130170001	FAN,PROP,24",CW,4-16	24	16°	CW	INTERCHANGEABLE		97.56
S1-LA-6130160001	FAN,PROP,24",CCW,4-16	24	16°	CCW	INTERCHANGEABLE		97.56
S1-LA-6130190001	FAN,PROP,24",CW,4-18	24	18°	CW	INTERCHANGEABLE		97.56
S1-LA-6130180001	FAN,PROP,24",CCW,4-18	24	18°	CCW	INTERCHANGEABLE		97.56
S1-LA-6131960001	FAN,PROP,24",CW,4-20,1/2" INTAKE HUB	24	20°	CW	DISCHARGE	1/2	97.56
S1-LA-6130210001	FAN,PROP,24",CW,4-20	24	20°	CW	INTERCHANGEABLE		97.56
S1-LA-6130200001	FAN,PROP,24",CCW,4-20	24	20°	CCW	INTERCHANGEABLE		97.56
S1-LA-60804301	FAN,PROP,24",CW,4-23	24	23°	CW	INTERCHANGEABLE		93.77
S1-LA-60804401	FAN,PROP,24",CCW,4-23	24	23°	CCW	INTERCHANGEABLE		93.77
S1-LA-60841701	FAN,PROP,24",CW,4-23,1/2" INTAKE HUB	24	23°	CCW	INTAKE	1/2	99.33
S1-LA-60841501	FAN,PROP,24",CW,4-25,1/2" INTAKE HUB	24	25°	CW	DISCHARGE	1/2	97.13
S1-LA-60559701	FAN,PROP,24",CW,4-27	24	27°	CW	INTERCHANGEABLE		98.90
S1-LA-60559801	FAN,PROP,24",CCW,4-27	24	27°	CCW	INTERCHANGEABLE		98.90
S1-LA-6130710001	FAN,PROP,24",CW,4-29,1/2" INTAKE HUB	24	29°	CW	INTAKE	1/2	69.68
S1-LA-60559901	FAN,PROP,24",CW,4-33	24	33°	CW	INTERCHANGEABLE		96.14
S1-LA-60560001	FAN,PROP,24",CCW,4-33	24	33°	CCW	INTERCHANGEABLE		93.77
S1-LA-60760701	FAN,PROP,26",CW,4-24	26	24°	CW	INTERCHANGEABLE		120.64
S1-LA-60760801	FAN,PROP,26",CCW,4-24	26	24°	CCW	INTERCHANGEABLE		116.69
S1-LA-60760901	FAN,PROP,26",CW,4-27	26	27°	CW	INTERCHANGEABLE		116.69
S1-LA-60761001	FAN,PROP,26",CCW,4-27	26	27°	CCW	INTERCHANGEABLE		116.69
S1-LA-60885701	FAN,PROP,26",CW,4-28,1/2" DISCH HUB	26	28°	CW	DISCHARGE	1/2	128.21
S1-LA-6130720001	FAN,PROP,26",CW,4-30,5/8" DISCH HUB	26	30°	CW	DISCHARGE	5/8	74.74
S1-LA-60997201	FAN,PROP,26",CW,4-32,5/8" DISCH HUB	26	32°	CW	DISCHARGE	5/8	141.45
S1-LA-60761101	FAN,PROP,26",CW,4-33	26	33°	CW	INTERCHANGEABLE		116.69
S1-LA-60761201	FAN,PROP,26",CCW,4-33	26	33°	CCW	INTERCHANGEABLE		120.64
S1-LA-6130730001	FAN,PROP,26",CW,4-38,3/4" DISCH HUB	26	38°	CW	DISCHARGE	3/4	103.18
S1-LA-61017601	FAN,PROP,28",CW,4-25,5/8" DISCH HUB	28	25°	CW	DISCHARGE	5/8	72.80
S1-LA-6129170001	FAN,PROP,28",CW,4-29,1/2" DISCH HUB	28	29°	CW	DISCHARGE	1/2	87.94
S1-LA-6130750001	FAN,PROP,28",CW,4-34,5/8" DISCH HUB	28	34°	CW	DISCHARGE	5/8	90.66
S1-LA-6130760001	FAN,PROP,30",CW,4-22,5/8" DISCH HUB	30	22°	CW	INTAKE	5/8	87.91
S1-LA-60943701	FAN,PROP,30",CW,4-25,5/8" DISCH HUB	30	25°	CW	DISCHARGE	5/8	160.70
S1-LA-6131250001	FAN,PROP,30",CW,4-27	30	27°	CW	INTERCHANGEABLE		124.68
S1-LA-6131240001	FAN,PROP,30",CCW,4-27	30	27°	CCW	INTERCHANGEABLE		124.68
S1-LA-6127600001	FAN,PROP,30",CW,4-27,5/8" DISCH HUB	30	27°	CW	DISCHARGE	5/8	112.06
S1-LA-6127290001	FAN,PROP,30",CW,4-30,5/8" DISCH HUB	30	30°	CW	DISCHARGE	5/8	111.59
S1-LA-6131260001	FAN,PROP,30",CCW,4-33	30	33°	CCW	INTERCHANGEABLE		124.68
S1-LA-6131270001	FAN,PROP,30",CW,4-33	30	33°	CW	INTERCHANGEABLE		124.68
S1-LA-6130770001	FAN,PROP,30",CW,4-40,5/8" INTAKE HUB	30	40°	CW	INTAKE	5/8	88.39

MOTORS & MOTOR ACCESSORIES

Cobra Blade

LAU PROPELLERS - 3-BLADE PROPELLERS

Application: Condensing Units Desiring Low Noise and High Efficiency



Features:

The Cobra Blade can be used to replace a square condenser propeller to make the unit 10X quieter. Cobra Blades are made of high strength aluminum.

SOURCE 1 PART NO.	DESCRIPTION	DIAMETER	PITCH	ROTATION	HUB LOCATION	MLP \$
S1-LA-6140570001	FAN,PROP,22",CW,3-20,COBRA BLADE	22	20°	CW	INTERCHANGEABLE	71.06
S1-LA-6140610001	FAN,PROP,22",CW,3-24,COBRA BLADE	22	24°	CW	INTERCHANGEABLE	71.06
S1-LA-6140660001	FAN,PROP,22",CW,3-28,COBRA BLADE	22	28°	CW	INTERCHANGEABLE	71.06
S1-LA-6140720001	FAN,PROP,22",CW,3-34,COBRA BLADE	22	34°	CW	INTERCHANGEABLE	71.06
S1-LA-6139720001	FAN,PROP,24",CCW,3-20,COBRA BLADE	24	20°	CCW	INTERCHANGEABLE	87.87
S1-LA-6139840001	FAN,PROP,24",CCW,3-24,COBRA BLADE	24	24°	CCW	INTERCHANGEABLE	87.87
S1-LA-6139920001	FAN,PROP,24",CCW,3-28,COBRA BLADE	24	28°	CCW	INTERCHANGEABLE	87.87
S1-LA-6140040001	FAN,PROP,24",CCW,3-34,COBRA BLADE	24	34°	CCW	INTERCHANGEABLE	87.87
S1-LA-6140190001	FAN,PROP,26",CW,3-20,COBRA BLADE	26	20°	CW	INTERCHANGEABLE	104.79
S1-LA-6140250001	FAN,PROP,26",CW,3-24,COBRA BLADE	26	24°	CW	INTERCHANGEABLE	104.79
S1-LA-6140330001	FAN,PROP,26",CW,3-28,COBRA BLADE	26	28°	CW	INTERCHANGEABLE	104.79
S1-LA-6140470001	FAN,PROP,26",CW,3-34,COBRA BLADE	26	34°	CW	INTERCHANGEABLE	46.45
S1-LA-6139530001	FAN,PROP,28",CCW,3-20,COBRA BLADE	28	20°	CCW	INTERCHANGEABLE	118.27
S1-LA-6139560001	FAN,PROP,28",CCW,3-24,COBRA BLADE	28	24°	CW	INTERCHANGEABLE	118.27
S1-LA-6139590001	FAN,PROP,28",CCW,3-28,COBRA BLADE	28	28°	CCW	INTERCHANGEABLE	118.27

LAU PROPELLERS - 4-BLADE PROPELLERS

Application: Condensing Units Desiring Low Noise and High Efficiency



Features:

The Cobra Blade can be used to replace a square condenser propeller to make the unit 10X quieter. Cobra Blades are made of high strength aluminum.

SOURCE 1 PART NO.	DESCRIPTION	DIAMETER	PITCH	ROTATION	HUB LOCATION	MLP \$
S1-LA-6139620001	FAN,PROP,28",CCW,3-34,COBRA BLADE	28	34°	CCW	INTERCHANGEABLE	118.27
S1-LA-6140580001	FAN,PROP,22",CW,4-20,COBRA BLADE	22	20°	CW	INTERCHANGEABLE	92.90
S1-LA-6140620001	FAN,PROP,22",CW,4-24,COBRA BLADE	22	24°	CW	INTERCHANGEABLE	92.90
S1-LA-6140670001	FAN,PROP,22",CW,4-28,COBRA BLADE	22	28°	CW	INTERCHANGEABLE	92.90
S1-LA-6140730001	FAN,PROP,22",CW,4-34,COBRA BLADE	22	34°	CW	INTERCHANGEABLE	92.90
S1-LA-6139740001	FAN,PROP,24",CCW,4-20,COBRA BLADE	24	20°	CCW	INTERCHANGEABLE	118.52
S1-LA-6139860001	FAN,PROP,24",CCW,4-24,COBRA BLADE	24	24°	CCW	INTERCHANGEABLE	118.52
S1-LA-6139940001	FAN,PROP,24",CCW,4-28,COBRA BLADE	24	28°	CCW	INTERCHANGEABLE	118.52
S1-LA-6140060001	FAN,PROP,24",CCW,4-34,COBRA BLADE	24	34°	CCW	INTERCHANGEABLE	118.52
S1-LA-6140200001	FAN,PROP,26",CCW,4-20,COBRA BLADE	26	20°	CCW	INTERCHANGEABLE	127.01
S1-LA-6140260001	FAN,PROP,26",CCW,4-24,COBRA BLADE	26	24°	CCW	INTERCHANGEABLE	127.01
S1-LA-6140340001	FAN,PROP,26",CCW,4-28,COBRA BLADE	26	28°	CCW	INTERCHANGEABLE	127.01
S1-LA-6140480001	FAN,PROP,26",CCW,4-34,COBRA BLADE	26	34°	CCW	INTERCHANGEABLE	127.01
S1-LA-6139540001	FAN,PROP,28",CCW,4-20,COBRA BLADE	28	20°	CCW	INTERCHANGEABLE	145.89
S1-LA-6139570001	FAN,PROP,28",CCW,4-24,COBRA BLADE	28	24°	CCW	INTERCHANGEABLE	145.89
S1-LA-6139600001	FAN,PROP,28",CCW,4-28,COBRA BLADE	28	28°	CCW	INTERCHANGEABLE	145.89
S1-LA-6139630001	FAN,PROP,28",CCW,4-34,COBRA BLADE	28	34°	CCW	INTERCHANGEABLE	145.89

Cobra Blade

LAU INTERCHANGEABLE HUBS FOR 3, 4 & 5-BLADE PROPELLERS

Application: Condensing Units Desiring Low Noise and High Efficiency



Features:

- All steel with extra metal for durability in the two mounting surfaces (hex & round)
- One inventory for all propellers-hex on one side, round on the other (use either)
- 5/8" and 3/4" models have keyway with extended body length for increased strength
- Double locking extended grips threads without backing out
- Lau HEX design transfers the torque from the screws to the hub and spider

SOURCE 1 PART NO.	DESCRIPTION	BORE SIZE	SET SCREW	MLP \$
S1-LA-60765801	HUB,HEX/RND,1/4" BORE	1/4	1	11.86
S1-LA-60765802	HUB,HEX/RND,5/16" BORE	5/16	1	11.86
S1-LA-60765803	HUB,HEX/RND,3/8" BORE	3/8	1	11.86
S1-LA-60765804	HUB,HEX/RND,1/2" BORE	1/2	2	10.99
S1-LA-60765805	HUB,HEX/RND,5/8" BORE	5/8	2	13.80
S1-LA-60765806	HUB,HEX/RND,3/4" BORE	3/4	2	13.80

LAU SERVICE TOOLS

Replacements Parts for Hub Pullers



Heavy Duty Features:

- Zinc plated,heavy steel construction.
- Sight holes for visual alignment of puller and motor shaft.
- Four square head cup point grab bolts.
- 5/8" bolt will not bend with proper use.
- Bar top.....grip with wrench.
- 1/4" steel collar.
- 1" long threaded surface.
- Torque Limit: 75 ft. lbs.

General Duty Features:

- Precision machined.
- 5/8" steel bolt machined and tapered on one end.
- 1 1/4" threaded into body resists stripping.
- Standard 1/8" wrench fitting.
- Four grab bolts for maximum holding power.
- Torque Limit: 75 ft. lbs.

SOURCE 1 PART NO.	DESCRIPTION	MLP \$
S1-LA-05380401	PULLER,HUB,5/8" SFT,HEAVY DUTY	108.59
S1-LA-05214101	PULLER,HUB,5/8" SFT,STD DUTY	110.96

Pitch Gauge



Measures the correct pitch & rotation direction

SOURCE 1 PART NO.	DESCRIPTION	MLP \$
S1-LA-05099801	GAUGE,PITCH	37.44

MOTORS & MOTOR ACCESSORIES

Blower Assemblies

LAU BELT DRIVE BLOWERS

Application: Residential & Light Commercial



SOURCE 1 PART NO.	DESCRIPTION	MODEL NUMBER	K DIM	E DIM	A DIM	B DIM	SHAFT SIZE	MLP \$
S1-LA-0574300001M	BLW ASSEM,9X6 WHL,SHAFT,& BRGS,A9-6ACE	A9-6ACE	8-1/4	10-1/4	15-7/16	14-15/16	3/4	414.68
S1-LA-0574300002M	BLW ASSEM,9X7 WHL,SFT,&BRGS,A9-7ACE	A9-7ACE	9-3/16	10-1/4	15-7/16	14-15/16	3/4	427.15
S1-LA-0574300003M	BLW ASSEM,9X9 WHL,SFT,&BRGS,A9-9ACE	A9-9ACE	11-7/8	10-1/4	15-7/16	14-15/16	3/4	427.15
S1-LA-0574310001M	BLW ASSEM,10X6 WHL,SHAFT,& BRGS,A10-6ACE	A10-6ACE	8-1/4	11-3/8	17-1/4	16-1/2	3/4	457.68
S1-LA-0574310002M	BLW ASSEM,10X8 WHL,SFT,& BRGS,A10-8ACE	A10-8ACE	10-1/2	11-3/8	17-1/4	16-1/2	3/4	471.38
S1-LA-0574310003M	BLW ASSEM,10X10 WHL,SFT,& BRGS,A10-10ACE	A10-10ACE	13-1/16	11-3/8	17-1/4	16-1/2	3/4	457.68
S1-LA-3824340021M	BLW ASSEM,12X6 WHL,SFT,& BRGS,A12-6ACE	A12-6ACE	8-13/16	13-7/16	20-7/16	19-5/16	1	583.46
S1-LA-3824340022M	BLW ASSEM,12X9 WHL,SFT,&BRGS,A12-9ACE A12-9ACE	A12-9ACE	12-3/8	13-7/16	20-7/16	19-5/16	1	656.18
S1-LA-38243420M	BLW ASSEM,12X12 WHL,SFT,&BRGS,A12-12 ACE	A12-12ACE	15-3/4	13-7/16	20-7/16	19-5/16	1	697.33
S1-LA-3820800003M	BLW ASSEM,15X9 WHL,SHAFT,& BRGS,A15-9ACE	A15-9ACE	12-13/16	15-7/8	24-1/8	22-5/8	1	949.37
S1-LA-3820800004M	BLW ASSEM,15X11 WHL,SFT,& BRGS,A15-11ACE	A15-11ACE	14-11/16	15-7/8	24-1/8	22-5/8	1	977.84
S1-LA-382080002M	BLW ASSEM,15X15 WHL,SFT,& BRGS,A15-15ACE	A15-15ACE	18-5/8	15-7/8	24-1/8	22-5/8	1	1075.44
S1-LA-3824300003M	BLW ASSEM,18X13 WHL,SFT,& BRGS,A18-13ACE	A18-13ACE	17-3/8	18-7/8	29-3/16	27	1	1571.96
S1-LA-38243002M	BLW ASSEM,18X18 WHL, SFT,& BRGS,A18-18ACE	A18-18ACE	21-7/8	18-7/8	29-3/16	27	1	1720.77

LAU DIRECT DRIVE BLOWERS

Application: Residential & Light Commercial



Direct Drive Blower Assemblies Consists of:

- Heavy gauge steel blower
- Blower wheel
- Adjustable motor mounting bracket
- Vibro-Pads
- Universal housing supports

SOURCE 1 PART NO.	DESCRIPTION	MODEL NUMBER	K DIM	E DIM	A DIM	B DIM	C DIM	D DIM	F DIM	G DIM	SHAFT SIZE	MLP \$
S1-LA-38251301M	BLW ASSEM,9X7 WHL,MTG BRKT,PADS,DD9-7	DD9-7A	9-3/16	10-1/4	17	14-15/16	15-1/16	14-15/16	15-9/16	1-1/4	1/2 BORE	286.81
S1-LA-38251302M	BLW ASSEM,9X9 WHL,MTG BRKT,PADS,DD9-9	DD9-9A	11-7/8	10-1/4	17	14-15/16	15-1/16	14-15/16	15-9/16	7/8	1/2 BORE	286.81
S1-LA-38251303M	BLW ASSEM,10X8 WHL,MTG BRKT,PADS,DD10-8	DD10-8A	10-1/2	11-3/8	18-7/8	16-1/2	16-11/16	16-1/2	17-1/2	1-1/8	1/2 BORE	330.30
S1-LA-38251304M	BLW ASSEM,10X10 WHL,MTG BRK,PADS,DD10-10	DD10-10A	13-1/16	11-3/8	18-7/8	16-1/2	16-11/16	16-1/2	17-1/2	5/8	1/2 BORE	339.15
S1-LA-02484028M	BLW ASSEM,12X9 WHL,MTG BRKT,PADS,DD12-9	DD12-9A	12-1/4	13-7/16	21-7/8	19-3/8	19-1/2	19-3/8	20-1/2	1-5/16	1/2 BORE	329.69
S1-LA-02484029M	BLW ASSEM,12X12 WHL,MTG BRK,PADS,DD12-12	DD12-12A	15-5/8	13-7/16	21-7/8	19-3/8	19-1/2	19-3/8	20-1/2	1-5/16	1/2 BORE	605.97

Blower Assemblies

LAU DOUBLE INLET - ALUMINUM WITH STEEL HUBS

Application: Commercial, Industrial & Consumer



MOTORS & MOTOR ACCESSORIES

SOURCE 1 PART NO.	DESCRIPTION	DIAMETER	WIDTH	ROTATION	BORE SIZE	RPM	MLP \$
S1-LA-02895808	WHL,BLW,4-3/4X5-1/8,CW,1/2 BORE,DBL INLT	4-3/4	5-1/8	CW	1/2	3450	61.41
S1-LA-02895814	WHL,BLW,4-3/4X5-1/8,CCW,1/2 BORE,DBL INL	4-3/4	5-1/8	CCW	1/2	3450	69.41
S1-LA-02895801	WHL,BLW,4-3/4X6-7/8,CW,1/2 BORE,DBL INLT	4-3/4	6-7/8	CW	1/2	3450	54.44
S1-LA-02895815	WHL,BLW,4-3/4X6-7/8,CCW,1/2 BORE,DBL INL	4-3/4	6-7/8	CCW	1/2	3450	54.44
S1-LA-02895802	WHL,BLW,5-1/4X5-7/8,CW,1/2 BORE,DBL INLT	5-1/4	5-7/8	CW	1/2	3450	54.44
S1-LA-02895816	WHL,BLW,5-1/4X5-7/8,CCW,1/2 BORE,DBL INL	5-1/4	5-7/8	CCW	1/2	3450	54.44
S1-LA-02895818	WHL,BLW,5-1/4X6-3/4,CW,1/2 BORE,DBL INLT	5-1/4	6-3/4	CW	1/2	3450	67.43
S1-LA-02895817	WHL,BLW,5-1/4X6-3/4,CCW,1/2 BORE,DBL INL	5-1/4	6-3/4	CCW	1/2	3450	67.43
S1-LA-02895803	WHL,BLW,5-1/4X6-7/8,CW,1/2 BORE,DBL INLT	5-1/4	6-7/8	CW	1/2	3450	67.88
S1-LA-02895819	WHL,BLW,5-1/4X6-7/8,CCW,1/2 BORE,DBL INL	5-1/4	6-7/8	CCW	1/2	3450	72.23
S1-LA-02895804	WHL,BLW,5-3/4X5-7/8,CW,1/2 BORE,DBL INLT	5-3/4	5-7/8	CW	1/2	3450	67.17
S1-LA-02895820	WHL,BLW,5-3/4X5-7/8,CCW,1/2 BORE,DBL INL	5-3/4	5-7/8	CCW	1/2	3450	73.88
S1-LA-02895805	WHL,BLW,5-3/4X6-7/8,CW,1/2 BORE,DBL INLT	5-3/4	6-7/8	CW	1/2	3450	67.81
S1-LA-02895821	WHL,BLW,5-3/4X6-7/8,CCW,1/2 BORE,DBL INL	5-3/4	6-7/8	CCW	1/2	3450	73.85
S1-LA-02895822	WHL,BLW,5-3/4X7-5/8,CW,1/2 BORE,DBL INLT	5-3/4	7-5/8	CW	1/2	3450	71.51
S1-LA-02895823	WHL,BLW,5-3/4X7-5/8,CCW,1/2 BORE,DBL INL	5-3/4	7-5/8	CCW	1/2	3450	71.51
S1-LA-02895824	WHL,BLW,5-3/4X8,CW,1/2 BORE,DBL INLET	5-3/4	8	CW	1/2	3450	74.02
S1-LA-02895825	WHL,BLW,5-3/4X8,CCW,1/2 BORE,DBL INLET	5-3/4	8	CCW	1/2	3450	72.23
S1-LA-02895806	WHL,BLW,5-3/4X8-1/2,CW,1/2 BORE,DBL INLT	5-3/4	8-1/2	CW	1/2	3450	68.55
S1-LA-02895826	WHL,BLW,5-3/4X8-1/2,CCW,1/2 BORE,DBL INL	5-3/4	8-1/2	CCW	1/2	3450	88.09
S1-LA-02895827	WHL,BLW,6-5/16X6-3/8,CW,3/4 BORE,DBL INL	6-5/16	6-3/8	CW	3/4	3450	73.85
S1-LA-02895828	WHL,BLW,6-5/16X6-3/8,CCW,3/4 BORE,DBL IN	6-5/16	6-3/8	CCW	3/4	3450	73.85
S1-LA-02895807	WHL,BLW,6-5/16X7-5/8,CW,1/2" BORE,DBL INL	6-5/16	7-5/8	CW	1/2	3450	74.33
S1-LA-02895829	WHL,BLW,6-5/16X7-5/8,CCW,1/2 BORE,DBL INL	6-5/16	7-5/8	CCW	1/2	3450	80.42
S1-LA-02895832	WHL,BLW,7-1/2X4,CW,3/4 BORE,DBL INLET	7-1/2	4	CW	3/4	2500	112.04
S1-LA-02895833	WHL,BLW,7-1/2X4,CCW,3/4 BORE,DBL INLET	7-1/2	4	CCW	3/4	2500	112.04
S1-LA-02895834	WHL,BLW,7-1/2X5,CW,3/4 BORE,DBL INLET	7-1/2	5	CW	3/4	2500	115.23
S1-LA-02895835	WHL,BLW,7-1/2X5,CCW,3/4 BORE,DBL INLET	7-1/2	5	CCW	3/4	2500	115.23
S1-LA-02895836	WHL,BLW,7-1/2X6-11/32,CW,3/4 BORE,DBL IN	7-1/2	6-11/32	CW	3/4	1800	115.23
S1-LA-02895837	WHL,BLW,7-1/2X6-11/32,CCW,3/4 BORE,DI	7-1/2	6-11/32	CCW	3/4	1800	115.23

Blower Assemblies

LAU DOUBLE INLET, DIRECT DRIVE

Lau's Universal Replacement Wheel



Features:

- Galvanized, Universal Replacement wheels
- 9" - 11" double inlet with precise blade spacing and consistency in alignment and balance
- Quiet performance, forward curved wheel
- Preslok Center disc with a special hub for use with direct drive blowers

SOURCE 1 PART NO.	DESCRIPTION	LAU MODEL	BORE SIZE	ROT.	CENTER DISC	MAX RPM	D DIM	WDIM	X DIM	UDIM	Z DIM	H DIM	MLP \$
S1-LA-01333401	WHL,BLW,9X4,CW,1/2 BORE,CNVX,DD9-4A	DD9-4A	1/2	CW	Convex	1750	9-1/2	4-1/2	7-11/16	1-1/4	1-25/32	43	120.18
S1-LA-01333501	WHL,BLW,9X6,CW,1/2 BORE,CNVX,DD9-6A	DD9-6A	1/2	CW	Convex	1750	9-1/2	6	7-11/16	1-1/4	1-25/32	43	131.22
S1-LA-01333602	WHL,BLW,9X7,CW,1/2 BORE,CNVX,DD9-7A	DD9-7A	1/2	CW	Convex	1750	9-1/2	7-1/8	7-11/16	1-1/4	1-25/32	43	134.51
S1-LA-01333603	WHL,BLW,9X7,CCW,1/2 BORE,CNVX,DD9-7A	DD9-7A	1/2	CCW	Convex	1750	9-1/2	7-1/8	7-11/16	1-1/4	1-25/32	43	120.03
S1-LA-01333701	WHL,BLW,9X8,CW,1/2 BORE,CNVX,DD9-8A	DD9-8A	1/2	CW	Convex	1750	9-1/2	8	7-11/16	1-1/4	1-25/32	43	126.74
S1-LA-01333703	WHL,BLW,9X8,CW,1/2 BORE,CNVX,DD9-8A	DD9-8A	1/2	CCW	Convex	1750	9-1/2	8	7-11/16	1-1/4	1-25/32	43	120.18
S1-LA-01333201	WHL,BLW,9X9,CW,1/2 BORE,CNVX,DD9-9A	DD9-9A	1/2	CW	Concave	1750	9-1/2	9-1/2	7-11/16	1-1/4	7/32	43	120.18
S1-LA-01333203	WHL,BLW,9X9,CCW,1/2 BORE,CNCV,DD9-9A	DD9-9A	1/2	CCW	Concave	1750	9-1/2	9-1/2	7-11/16	1-1/4	7/32	43	120.18
S1-LA-01332701	WHL,BLW,10X4,CW,1/2 BORE,CNVX,DD10-4A	DD10-4A	1/2	CW	Convex	1750	10-5/8	4-1/2	8-7/8	1-1/4	1-15/16	48	137.82
S1-LA-01332601	WHL,BLW,10X6,CW,1/2 BORE,CNVX,DD10-6A	DD10-6A	1/2	CW	Convex	1750	10-5/8	6	8-7/8	1-1/4	1-15/16	48	134.44
S1-LA-01332602	WHL,BLW,10X6,CCW,1/2 BORE,CNVX,DD10-6A	DD10-6A	1/2	CCW	Convex	1750	10-5/8	6	8-7/8	1-1/4	1-15/16	48	134.28
S1-LA-01332614	WHL,BLW,10X6,CW,5/8 BORE,CNVX,DD10-6A	DD10-6A	5/8	CW	Convex	1750	10-5/8	6	8-7/8	1-1/4	1-15/16	48	134.44
S1-LA-01332501	WHL,BLW,10X7,CW,1/2 BORE,CNVX,DD10-7A	DD10-7A	1/2	CW	Convex	1750	10-5/8	7-1/8	8-7/8	1-1/4	1-15/16	48	134.44
S1-LA-02710204	WHL,BLW,10X7,CCW,1/2 BORE,CNVX,DD10-7A	DD10-7A	1/2	CCW	Convex	1750	10-5/8	7-1/8	8-7/8	1-1/4	1-15/16	48	134.28
S1-LA-01332401	WHL,10X8,CW,1/2 BORE,CNVX,DD10-8A	DD10-8A	1/2	CW	Convex	1750	10-5/8	8	8-7/8	1-1/4	1-15/16	48	134.44
S1-LA-01332402	WHL,BLW,10X8,CCW,1/2 BORE,CNVX,DD10-8A	DD10-8A	1/2	CCW	Convex	1750	10-5/8	8	8-7/8	1-1/4	1-15/16	48	134.28
S1-LA-01331701	WHL,BLW,10X9,CW,1/2 BORE,CNCV,DD10-9A	DD10-9A	1/2	CW	Concave	1750	10-5/8	9-1/2	8-7/8	1-1/4	1/16	48	134.44
S1-LA-01331704	WHL,BLW,10X9,CCW,1/2 BORE,CNCV,DD10-9A	DD10-9A	1/2	CCW	Concave	1750	10-5/8	9-1/2	8-7/8	1-1/4	1/16	48	134.44
S1-LA-01332301	WHL,BLW,10X9,CW,1/2 BORE,CNVX,DD10-9A	DD10-9A	1/2	CW	Convex	1750	10-5/8	9-1/2	8-7/8	1-1/4	1/16	48	141.78
S1-LA-01331602	WHL,BLW,10X10,CW,1/2 BORE,CNCV,DD10-10A	DD10-10A	1/2	CW	Concave	1750	10-5/8	10-5/8	8-7/8	1-1/4	1/16	48	137.82
S1-LA-01332203	WHL,BLW,10X10,CW,1/2 BORE,CNCV,DD10-10A	DD10-10A	1/2	CW	Convex	1750	10-5/8	10-5/8	8-7/8	1-1/4	1/16	48	134.44
S1-LA-01331606	WHL,BLW,10X10,CCW,1/2 BORE,CNCV,DD10-10A	DD10-10A	1/2	CCW	Concave	1750	10-5/8	10-5/8	8-7/8	1-1/4	1/16	48	141.78
S1-LA-02694003	WHL,BLW,11X6,CW,1/2 BORE,CNVX,DD11-6A	DD11-6A	1/2	CW	Convex	1550	11-3/4	6	10	1-1/4	2	53	153.16
S1-LA-02694005	WHL,BLW,11X7,CW,1/2 BORE,CNVX,DD11-7A	DD11-7A	1/2	CW	Convex	1550	11-3/4	7-1/8	10	1-1/4	2	53	153.16
S1-LA-02694007	WHL,BLW,11X8,CW,1/2 BORE,CNVX,DD11-8A	DD11-8A	1/2	CW	Convex	1550	11-3/4	8	10	1-1/4	2	53	153.01
S1-LA-02694107	WHL,BLW,11X8,CW,1/2 BORE,CNCV,DD11-8A	DD11-8A	1/2	CW	Concave	1550	11-3/4	8	10	1-1/4	1/16	53	153.16
S1-LA-02694008	WHL,BLW,11X8,CCW,1/2 BORE,CNVX,DD11-8A	DD11-8A	1/2	CCW	Convex	1550	11-3/4	8	10	1-1/4	2	53	153.01
S1-LA-02694009	WHL,BLW,11X9,CW,1/2 BORE,CNVX,DD11-9A	DD11-9A	1/2	CW	Convex	1550	11-3/4	9-1/2	10	1-1/4	2	53	161.56
S1-LA-02694010	WHL,BLW,11X9,CCW,1/2 BORE,CNVX,DD11-9A	DD11-9A	1/2	CCW	Convex	1550	11-3/4	9-1/2	10	1-1/4	2	53	153.01
S1-LA-02694111	WHL,BLW,11X10,CW,1/2 BORE,CNCV,DD11-10A	DD11-10A	1/2	CW	Concave	1550	11-3/4	10-5/8	10	1-1/4	1/16	53	153.16
S1-LA-02694112	WHL,BLW,11X10,CCW,1/2 BORE,CNCV,DD11-10A	DD11-10A	1/2	CCW	Concave	1550	11-3/4	10-5/8	10	1-1/4	1/16	53	153.16
S1-LA-01369325	WHL,BLW,12X9,CW,1/2 BORE,CNVX,DD12-9A	DD12-9A	1/2	CW	Convex	1200	12-5/8	9-1/2	10-5/16	1-1/4	2	43	195.56
S1-LA-01369315	WHL,BLW,12X9,CW,5/8 BORE,CNVX,DD12-9A	DD12-9A	5/8	CW	Convex	1200	12-5/8	9-1/2	10-5/16	1-1/4	2	43	179.35

MOTORS & MOTOR ACCESSORIES

Blower Parts & Accessories

LAU INSTALLATION PARTS

Thrust Collar Kit



Features:

- Sheet metal thrust collar in 3/4", 5/8" and 1" size. All with hollow head (Allen) setscrews.
- Kit consists of one pair packaged with thrust washers. Order by part number.

SOURCE 1 PART NO.	DESCRIPTION	SHAFT DIAMETER	MLP \$
S1-LA-38243101	KIT,THRUST COLLAR,5/8"	5/8"	22.63
S1-LA-38220601	KIT,THRUST COLLAR, 3/4"	3/4"	17.79
S1-LA-38220701	KIT, THRUST COLLAR, 1"	1"	23.38

Thrust Spacer Kit



SOURCE 1 PART NO.	DESCRIPTION	SHAFT DIAMETER	MLP \$
S1-LA-38249101	KIT,THRUST SPACER,5/8"	5/8"	14.23
S1-LA-38249102	KIT,THRUST SPACER,3/4"	3/4"	15.98
S1-LA-38249103	KIT,THRUST SPACER,1"	1"	17.45

Vibro-Pads - 5/16 Hole



Features:

- Resilient rubber pads snap easily into place. Reduces vibration, wear and noise on blowers, fans, motors, etc.

SOURCE 1 PART NO.	DESCRIPTION	MLP \$
S1-LA-38220901	PADS,VIBRATION,PK OF 12	17.79

Motor Mounting Hardware Kit



Features:

- Motor attachment and adjustment hardware for 9", 10", 12" and 15" blowers.

SOURCE 1 PART NO.	DESCRIPTION	MLP \$
S1-LA-38252101	KIT,HARDWARE,MTR MTG,FOR 9"-15" BLWRS	32.71

Shafts



Features:

- When a bearing fails, the shaft is inevitably scored. If not replaced, it will destroy the new bearings.
- Premium shafting is ground and polished 1018 cold rolled steel. Excess shaft may be cut off. (Keyways and/or Flats are to be added as required in the field).
- When replacing bearings, be sure to replace the shaft.

SOURCE 1 PART NO.	DESCRIPTION	MLP \$
S1-LA-38220501	SHAFT,BLOWER, 5/8" DIA X 20" LONG	45.06
S1-LA-38209601	SHAFT,BLOWER, 3/4" DIA X 20" LONG	57.64
S1-LA-38269301	SHAFT,BLOWER, 3/4" DIA X 35" LONG	43.27
S1-LA-38209501	SHAFT,BLOWER, 1" DIA X 25" LONG	80.33
S1-LA-38249201	SHAFT,BLOWER, 1" DIA X 35" LONG	116.21

MOTORS & MOTOR ACCESSORIES

LAU BEARINGS

Cartridge Type Sleeve Bearings



Features:

- Designed to give you fast, easy interchangeability. It will fit any "spider type" bracket used on 9", 10" & 12" blowers.
- Sintered bronze bushing pressed into steel bearing caps and cushioned in heavy neoprene conductive rubber.
- Factory packed with lubricant for many years of quiet, trouble-free service. The Cartridge Bearing with a Journal may permit use of old shaft.



SOURCE 1 PART NO.	DESCRIPTION	SHAFT DIAMETER	OD	MLP \$
S1-LA-38209101	BRG,CARTRIDGE,3/4",MKIV (PAIR)	3/4" W/ THRUST & SPACER	1-13/16"	58.83
S1-LA-38227201	BRG,CARTRIDG,W/JOURNAL,3/4",MKIII (PAIR)	3/4" W/ JOURNAL	1-13/16"	109.04
S1-LA-38209001	BRG,CARTRIDGE,1",MKIII (PAIR)	1"	1-13/16"	90.42

"Lau-Pak" - Sleeve Sealed Type Bearings With Insulator



Features:

- Self-aligning
- Durable construction
- Includes insulator
- Porous bronze sleeve
- Includes factory packed lubricant
- Sold in pairs



SOURCE 1 PART NO.	DESCRIPTION	SHAFT DIAMETER	OD	MLP \$
S1-LA-38244301	BRG,5/8",LAU-PAK (PAIR)	5/8"	1-13/16"	43.41
S1-LA-38244302	BRG,3/4",LAU-PAK (PAIR)	3/4"	1-13/16"	47.88
S1-LA-38244303	BRG,1",LAU-PAK (PAIR)	1"	2-1/2"	55.99

Pillow Block Sleeve Bearings



Features:

- Heavy neoprene cushion. Re-oilable porous bronze bushing in a pressed steel ball unit held firmly in a housing of two-piece interlocking steel.
- This high quality self-aligning, static free, pillow block will assure quiet operation and may years of trouble-free performance.
- Two 1/8" rubber spacers provided for use, if needed.

SOURCE 1 PART NO.	DESCRIPTION	SHAFT DIAMETER	MLP \$
S1-LA-38220401	BRG,SLEEVE,PB,5/8" (PAIR)	5/8"	37.56
S1-LA-38208601	BRG,SLEEVE,PB,3/4" (PAIR)	3/4"	37.96
S1-LA-38208701	BRG,SLEEVE,PB,1" (PAIR)	1"	37.96
S1-LA-38209301	BRG,SLEEVE,PB,1",HEAVY DUTY (PAIR)	1" HEAVY DUTY	65.81

Sealed Type Ball Bearings with Insulator



Features:

- For use when operating conditions exceed the limits of sleeve bearings or where repetitive failures occur. These bearings are pre-lubricated at the factory and require no further lubrication or attention. They are equipped with seals to retain grease better and to protect against contaminants.

SOURCE 1 PART NO.	DESCRIPTION	TEMPERATURE RANGE °F	SHAFT DIAMETER	OD	MLP \$
S1-LA-38258801	BRG,BALL,SEALED,3/4" (PAIR)	-20 + 180	3/4" W/ INTERLOCKING THRUST COLLAR	1-13/16"	128.06
S1-LA-38259001	BRG,BALL,SEALED,1" (PAIR)	-20 + 180	1" W/ INTERLOCKING THRUST COLLAR	2-17/32"	143.60
S1-LA-38256201	BRG,BALL,SEALED,1-3/16"	-20 + 180	1-13/16" W/ INTERLOCKING THRUST COLLAR	2-7/32"	379.00

Bearings

LAU BEARINGS

Lau Oil Type - Sleeve Bearings With Insulator



Features:

- Self-aligning, self-oiling, with bronze bushing held in housing under light, uniform spring pressure, providing uniform distribution of lubricant through pores of bushing.
- Drive type oil cup.
- Shipped dry. Lubricate at time of installation with SAE 20 or 30 weight oil.



SOURCE 1 PART NO.	DESCRIPTION	SHAFT DIAMETER	OD	MLP \$
S1-LA-38240401	BRG,5/8",LAU OIL (PAIR)	5/8"	1-13/16"	49.71
S1-LA-38244201	BRG,3/4",LAU OIL (PAIR)	3/4"	1-13/16"	52.75
S1-LA-38244202	BRG,1",LAU OIL (PAIR)	1"	2-1/2"	61.47
S1-LA-38245001	BRG,OIL,3/4" (PAIR)	3/4"	1-27/32"	50.36
S1-LA-38244901	BRG,OIL,1" (PAIR)	1"	1-27/32"	51.89
S1-LA-38209401	BRG,OIL,HEAVY DUTY,1"	1" HEAVY DUTY	2-1/2"	70.46

VPB SERIES



Features:

- Normal duty two-bolt pillow block
- Shaft diameter 2-3/16"

SOURCE 1 PART NO.	IND. STD.	SHAFT DIA	MLP \$
S1-02924422000	VPB-235	2.4375	725.78
S1-02924423000	VPB-239AH	2.1875	537.30

Mounting Brackets

MOTOR MOUNT - FLEX BRACKET

4 Leg



Torsion Flex Bracket holds motor securely. Fits 5-1/2" motors. Designed for applications with 9" or 10" bolt circle diameters, mounting legs are evenly spaced at 90° angles.



SOURCE 1 PART NO.	DESCRIPTION	MLP \$
S1-FM554	5-1/2" MOTOR MOUNT TORSION FLEX BRACKET	73.58

MOTOR BRACKET



SOURCE 1 PART NO.	DESCRIPTION	MLP \$
S1-DMB-1	FIXED LUG ASSEMBLY FOR 5-1/2" DIAMETER MOTORS	34.59

Mounting Brackets

A.O. SMITH FLEXIMOUNT ADAPTER



Adapt standard frame motor to Fleximount. Each adapter includes 3 grommets and 3 steel ferrules.

SOURCE 1 PART NO.	PART NO.	FRAME SIZE	MLP \$
S1-02427878000	619432-174	48	76.07
S1-02432032000	619432-192	42	68.45

LAU BRACKET & BRACKET KITS

Direct Drive Motor Mounting Brackets

Universal Motor Mounting Brackets



Features:

- Lau's Universal Motor Mounting
- Brackets accommodate 10" and 12"
- Blowers (includes mounting hardware)

SOURCE 1 PART NO.	DESCRIPTION	FRAME	BLOWER SIZE	MLP \$
S1-LA-02869101	BRKT,MTR,DD,42-FR,10" BLWR,WIRE	42-FRAME	10	46.53
S1-LA-02869201	BRKT,MTR,DD,48-FR,10" BLWR,WIRE	48-FRAME	10	46.53
S1-LA-05409101	BRKT,MTR,DD,48-FR,12" BLWR,WIRE	48-FRAME	12	57.38

Flexible Mount "Belly" Band Adapter



Features:

- Adapts either to a 5" diameter motor (42-frame), or a 5-5/8" (48-frame) to mount on 9" and 10" blowers.

SOURCE 1 PART NO.	DESCRIPTION	FITS	MLP \$
S1-LA-05407401	BRKT,MTR,DD,42-FR,BELLY BAND	5" MOTOR	38.49
S1-LA-05407402	BRKT,MTR,DD,48-FR,BELLY BAND	5-5/8" MOTOR	42.59

Sheaves

AL/YB SERIES

Single Groove Sheaves for "4L" or "A" Belts



Features:

- Machined cast iron construction
- Equipped with hollow head set screws
- Light duty, no keyseat
- Do not use "A" cogged belt ratings with these sheaves

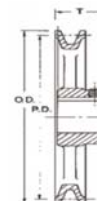

SOURCE 1 PART NO.	INDUSTRY STANDARD SHEAVE NO.	DIAMETERS			KEYSEAT	DIM T	WEIGHT LBS.	MLP \$
		O.D.	BORE	PITCH (P.D)				
S1-02804255700	YB5004	5.93	.75	5.78	Y	1.06	1.2	43.74

2MVP SERIES

Two Groove Sheaves for "A" & "B" Belts



Features:

- Machined cast iron construction
- Furnished with standard keyseats and 2 hollow head set screws
- Dynamically balanced

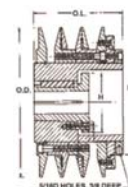

SOURCE 1 PART NO.	INDUSTRY STANDARD SHEAVE NO.	NO. OF GROOVES	O.D.	R.D.	OL	DATUM RANGE "A" BELT	DATUM RANGE "B" BELT	BORE DIA.	WT. (LBS)	MLP \$
S1-02812369700	2MVP60B74P	2	7.68	5.38	4.75	5.9-7.0	6.0-7.4		29.3	1973.79
S1-02813931000	2MVP35B49	2	5.18	3.31	3.63	3.4-4.5	3.5-4.9	1-3/8	9.8	1528.19

MOTORS & MOTOR ACCESSORIES

Sheaves

AK SERIES

Single Groove Sheaves for "4L", "A" or "3L" Belts



- Features:
- Painted, machined cast iron construction
 - Statically balanced
 - Furnished with standard keyseats
 - Furnished with hollow head set screws

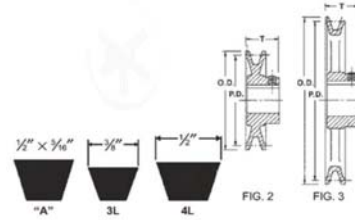

SOURCE 1 PART NO.	INDUSTRY STANDARD SHEAVE NO.	O.D.	BORE	PITCH (P.D) "A"/"4L" BELT	PITCH (P.D) "3L" BELT	DIM. T	KEYSEAT	FIG.	WEIGHT LBS	MLP \$
S1-02807216700	AK134X1	13.25	1	13.20	12.66	1.47	1/4" x 1/8"		7.5	270.10
S1-02808158700	AK104X1-3/16	10.25	1.188	10.00	9.66	1.47	1/4" x 1/8"	3	5.1	84.80
S1-02817110000	AK94X1	9.25	1	--	8.66		1/4"X1/8"		4.5	136.90
S1-02808255700	AK94X1-3/16	9.25	1.19	9.200	8.66	1.47	3/8"X3/16"		4.5	160.42
S1-02809570700	AK59X1	5.75	1.000	5.70	5.16	1.56	1/4" x 1/8"	3	2.0	34.29
S1-02809985700	AK66X1	6.45	1.000	6.40	5.86	1.56	1/4" x 1/8"	3	2.3	63.83
S1-02812363700	AK56X1	5.45	1.000	5.40	4.86	1.56	1/4" x 1/8"	3	1.9	101.27
S1-02812383700	AK61X1	5.95	1.000	5.90	5.36	1.56	1/4" x 1/8"	3	2.1	52.80
S1-02812384700	AK54X1	5.25	1.000	5.20	4.66	1.56	1/4" x 1/8"	3	1.8	39.85
S1-02812388700	AK39X1	3.75	1.000	3.70	3.16	1.56	1/4" x 1/8"	2	1.4	21.07
S1-02812765700	AK74X1	7.25	1.000	7.20	6.66	1.53	1/4" x 1/8"	3	3.4	101.17
S1-02812767700	AK84X1	8.25	1.000	8.20	7.66	1.53	1/4" x 1/8"	3	3.8	119.46
S1-02814878000	AK64X1	6.25	1	6.20	5.66	1.56	1/4" X 1/8"			78.34

2AK SERIES

Two Groove Sheaves for "4L" or "A" Belts



- Features:
- Painted, machined cast iron construction
 - Furnished with standard keyseats
 - Furnished with hollow head screws

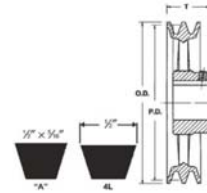

SOURCE 1 PART NO.	INDUSTRY STANDARD SHEAVE NO.	DIAMETERS				KEYSEAT	DIM T	WEIGHT LBS.	MLP \$
		O.D.	BORE	PITCH (P.D) "A" / "4L" BELT	PITCH (P.D.) "3L" BELT				
S1-02808256700	2AK94X1-3/16	9.20	1.188	9.00	8.66	1/4 x 1/8	1.719	7.3	195.92
S1-02808257700	2AK114X1-3/16	11.20	1.188	11.00	10.66	1/4 x 1/8	1.719	9.0	227.53

BK SERIES

Single Groove Sheaves for "4L", "A", "5L" & "B" Belts



- Features:
- Painted, machined cast iron construction
 - Statically balanced
 - Furnished with standard keyseats

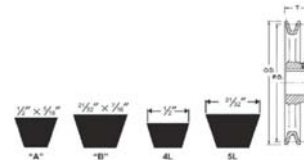

SOURCE 1 PART NO.	INDUSTRY STANDARD SHEAVE NO.	O.D.	BORE	PITCH (P.D.) "4L" / "A" BELT	PITCH (P.D.) "5L" / "B" BELT	DIM. T	WEIGHT LBS	MLP \$
S1-02804869700	BK115X1	11.25	1	10.70	11.20	1.47		196.81
S1-02810564700	BK80X1	7.75	1.000	7.20	7.70	1.47	4.4	78.93
S1-02810577700	BK120X1-3/16	11.75	1.188	11.20	11.70	1.47	7.4	124.02
S1-02812012700	BK110X1-3/16	10.75	1.188	10.20	10.70	1.47	6.4	201.74
S1-02812026700	BK90X1	8.75	1.000	8.20	8.70	1.47	5.0	185.99
S1-02812364700	BK67X1	6.45	1.000	5.90	6.40	1.56	2.8	71.55
S1-02815473000	BK62H	5.95		5.20	5.90	1.50	2.4	96.88
S1-02815474000	BK57H	5.45		4.70	5.10	1.50	2.3	96.40

Sheaves

2BK SERIES

Two Groove Sheaves for "4L" or "A" & "5L" or "B" Belts



Features:

- Painted, machined cast iron construction
- Statically balanced
- Furnished with standard keyseats
- Furnished with hollow head set screws

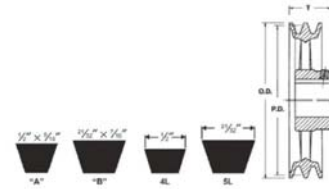

SOURCE 1 PART NO.	INDUSTRY STANDARD SHEAVE NO.	DIAMETERS				KEYSEAT	DIM T	WEIGHT LBS.	MLP \$
		O.D.	BORE	PITCH (P.D) "A" / "4L" BELT	PITCH (P.D.) "5L" BELT				
S1-02805419700	2BK70X1	6.75	1.000	6.20	6.70	1/4 x 1/8	2.094	6.6	257.28
S1-02808346000	2BK130H	12.75	1.188	8.60	12.7	1/4 x 1/8	1.75	15.85	398.32
S1-02809992700	2BK100X1-7/16	9.75	1.438	9.20	9.40	3/8 x 3/16	2.094	9.4	150.15

BKH SERIES

Single Groove Sheaves for "4L" or "A" & "5L" or "B" Belts



Features:

- Painted, machined cast iron construction
- Furnished with special keys to fit standard keyseats
- Requires "H" split taper bushings

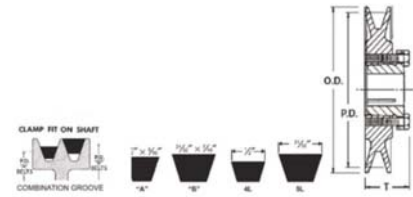

SOURCE 1 PART NO.	INDUSTRY STANDARD SHEAVE NO.	DIAMETERS			DIM T	WEIGHT LBS.	BUSHING REQ'D	MLP \$
		O.D.	PITCH (P.D) "4L" / "A" BELT	PITCH (P.D.) "5L" "B" BELT				
S1-02812773700	BK80H	7.75	7.20	7.70	1.28 H	1.56	H	123.51

2BKH SERIES

Two Groove Sheaves for "4L" or "A" & "5L" or "B" Belts



Features:

- Painted, machined cast iron construction
- Furnished with special keys to fit standard keyseats
- Requires "H" split taper bushings

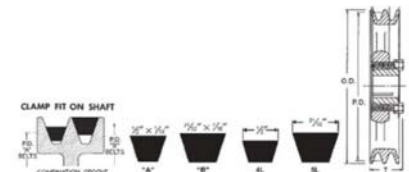

SOURCE 1 PART NO.	INDUSTRY STANDARD SHEAVE NO.	DIAMETERS			DIM T	WEIGHT LBS.	BUSHING REQ'D	MLP \$
		O.D.	PITCH (P.D) "4L" / "A" BELT	PITCH (P.D.) "5L" "B" BELT				
S1-02812368700	2BK110H	10.75	10.20	10.70	1.750	9.3	H	113.46

TB SERIES

Two Groove Gripbelt Sheaves with Split Taper Bushings



for use with all "A" & "B" Section Belts

Features:

- Painted, machined cast iron construction
- Furnished with standard keyseats

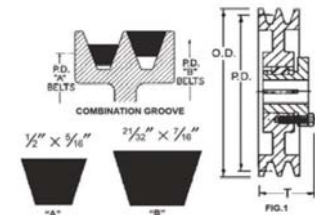

SOURCE 1 PART NO.	INDUSTRY STANDARD SHEAVE NO.	DIAMETERS			DIM T	WEIGHT LBS.	BUSHING REQ'D	MLP \$
		O.D.	PITCH (P.D) "4L" / "A" BELT	PITCH (P.D.) "5L" "B" BELT				
S1-02808525900	2TB110	11.35	10.80	11.30	2.83	19.45	Q1	441.15

Sheaves

TC SERIES

Two Groove Gripbelt Sheaves with Split Taper Bushings

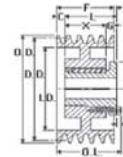

SOURCE 1 PART NO.	INDUSTRY STANDARD SHEAVE NO.	DIAMETERS					DIM O.L.	WEIGHT LBS. LESS BUSHING	MLP \$
		O.D.	BUSHING REQ'D	PITCH (P.D) "A" BELT	PITCH (P.D.) "B" BELT	PITCH (P.D.) "C" BELT			
S1-02808736700	2TC72	7.60	Q1	N/A	N/A	7.60	3.08	15.24	579.91
S1-02808769700	2TC106	11.00	Q1	N/A	N/A	11	3.08	21.7	812.24

B5V SERIES

Two Groove Gripbelt Sheaves with Split Taper Bushings



Features:

- Painted, machined cast iron construction
- For use with "A", "B" & "5V" belts
- Requires "B" split taper bushing

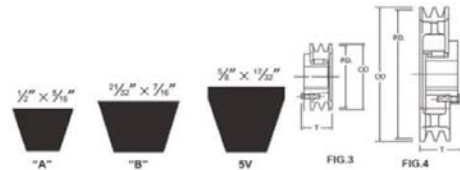

SOURCE 1 PART NO.	INDUSTRY STANDARD SHEAVE NO.	DIAMETERS					DIM T	FIG.	WEIGHT LBS. LESS BUSHING	MLP \$
		O.D.	BUSHING REQ'D	PITCH (P.D) "A" BELT	PITCH (P.D.) "B" BELT	PITCH (P.D.) "5V" BELT				
S1-02812070700	2B5V58	6.08	B	5.4	5.8	5.9	2.55	3	7.4	283.45
S1-02812307700	2B5V124	12.68	B	12.0	12.4	12.5	2.55	4	17.1	455.72
S1-02812308700	2B5V68	7.08	B	6.4	6.8	6.9	2.55	4	10.2	317.49
S1-02813269000	2B5V50	5.28	B	4.6	5.0	5.1	2.55	3	4.6	190.74
S1-02813270000	2B5V52	5.48	B	4.8	5.2	5.3	2.55	3	5.3	197.25
S1-02813271000	2B5V60	6.28	B	5.6	6.0	6.1	2.55	3	8.2	306.22
S1-02813272000	2B5V64	6.68	B	6.0	6.4	6.5	2.55	3	8.4	275.67
S1-02813358000	2B5V46	4.88	B	4.2	4.6	4.7	2.55	3	3.3	225.91
S1-02813359000	2B5V54	5.68	B	5.0	5.4	5.5	2.55	3	6.0	237.83
S1-02815946000	2B5V90			8.6	9.0	9.1				346.71

TB SERIES

Three Groove Gripbelt Sheaves with Split Taper Bushings



for use with all "A" & "B" Section Belts

Features:

- Painted, machined cast iron construction
- Furnished with standard keyseats

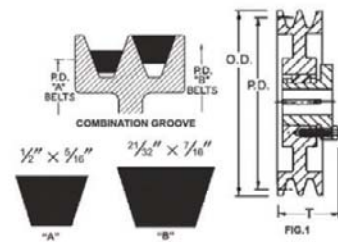

SOURCE 1 PART NO.	INDUSTRY STANDARD SHEAVE NO.	DIAMETERS			BUSHING REQ'D	DIM T	WEIGHT LBS.	MLP \$
		O.D.	PITCH (P.D) "A" BELT	PITCH (P.D.) "B" BELT				
S1-02812061700	3TB56	5.95	5.40	5.90	P1	2.703	9.0	299.65

Sheaves

1VP SERIES

Single Groove Variable Pitch Sheaves for "3L", "4L", "5L", "A", "B" & "5V" Belts



Features:

- Painted, machined cast iron or steel construction
- Furnished with hollow head set screws
- Dynamically balanced
- Vibration free operation

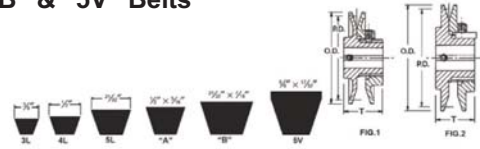

SOURCE 1 PART NO.	INDUSTRY STANDARD SHEAVE NO.	DIAMETERS		FIG.	DIM T	WEIGHT LBS.	MLP \$
		O.D.	BORE DIA				
S1-02804761700	1VP56X1-1/8	5.35	1.125	2	2.16	4.4	129.59
S1-02804763700	1VP56X7/8	5.35	.875	2	2.16	4.4	132.68
S1-02804765700	1VP62X1-1/8	5.95	1.125	2	2.22	6.1	162.33
S1-02806405700	1VP50X5/8	4.75	0.625	1	1.94	1.9	31.30
S1-02806434700	1VP40X5/8	3.75	.625	1	1.88	1.9	83.37
S1-02810436701	1VP34X1/2	3.15	0.5	1	1.88	1.2	85.57
S1-02810855700	1VP62X7/8	5.95	.875	2	2.22	6.1	189.67
S1-02812010700	1VP68X1-3/8	6.55	1.375	2	2.22	7.3	168.88
S1-02812365700	1VP50X1-1/8	4.75	1.125	2	2.16	3.6	98.53
S1-02812403700	1VP75X1-3/8	7.50	1.375	2	2.22	8.9	178.96
S1-02812774700	1VP34X7/8	3.15	.875	1	1.88	1.4	86.07
S1-02812775700	1VP44X7/8	4.15	.875	2	2.16	2.9	116.41
S1-02812776700	1VP44X1-1/8	4.15	1.125	2	2.16	2.9	114.21
S1-02812777700	1VP60X1-1/8	6.00	1.125	2	2.22	6.5	240.15
S1-02804807700	1VP50X7/8	4.75	0.875	1	1.93	4	79.25

MOTORS & MOTOR ACCESSORIES

SOURCE 1 PART NO.	DIAMETERS PITCH (P.D.)															
	"3L" BELTS				"4L" OR "A" BELTS				"5L" OR "B" BELTS				"5V" BELTS			
	MIN PITCH	TURNS OPEN	MAX PITCH	TURNS OPEN	MIN PITCH	TURNS OPEN	MAX PITCH	TURNS OPEN	MIN PITCH	TURNS OPEN	MAX PITCH	TURNS OPEN	MIN PITCH	TURNS OPEN	MAX PITCH	TURNS OPEN
S1-02812774700	1.7	4	2.5	0	2.0	5	3.0	0	2.5	5	3.3	1	—	—	—	—
S1-02806434700	2.3	4	3.1	0	2.6	5	3.6	0	2.8	6	3.8	1	—	—	—	—
S1-02812775700	2.7	4	3.5	0	3.0	5	4.0	0	3.2	6	4.2	1	—	—	—	—
S1-02812776700	2.7	4	3.5	0	3.0	5	4.0	0	3.2	6	4.2	1	—	—	—	—
S1-02812365700	3.3	4	4.1	0	3.6	5	4.6	0	3.8	6	4.8	1	—	—	—	—
S1-02804763700	3.9	4	4.7	0	4.2	5	5.2	0	4.4	6	5.4	1	—	—	—	—
S1-02804761700	3.9	4	4.7	0	4.2	5	5.2	0	4.4	6	5.4	1	—	—	—	—
S1-02810855700	—	—	—	—	4.4	5	5.4	0	4.7	6	5.9	0	4.7	6	5.9	0
S1-02804765700	—	—	—	—	4.4	5	5.4	0	4.7	6	5.9	0	4.7	6	5.9	0
S1-02812777700	—	—	—	—	4.4	5	5.4	0	4.7	6	5.9	0	4.7	6	5.9	0
S1-02812010700	5.1	4	5.9	0	4.9	5	5.9	0	5.2	6	6.4	0	5.2	6	6.4	0
S1-02812778700	—	—	—	—	5.5	5	6.5	0	5.8	6	7.0	0	5.8	6	7	0
S1-02812403700	—	—	—	—	5.9	5	6.9	0	6.2	6	7.4	0	6.2	6	7.4	0
S1-02804807700	3.3	4	4.1	0	3.6	5	4.6	0	3.8	6	4.8	1	—	—	—	—

2VP SERIES

Two Groove Variable Pitch Sheaves for "3L", "4L", "5L", "A", "B" & "5V" Belts



Features:

- Painted, machined cast iron or steel construction
- Dynamically balanced
- Furnished with hollow head set screws
- Vibration free operation

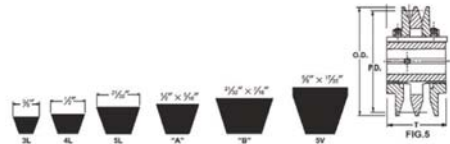

SOURCE 1 PART NO.	INDUSTRY STANDARD SHEAVE NO.	DIAMETERS		KEYSEAT	DIM T	FIG	WT. LBS.	MLP \$
		O.D.	BORE DIA					
S1-02804762700	2VP56X1-1/8	5.35	1.125	1/4 x 1/8	3.000	5	6.6	291.73
S1-02805447700	2VP62X1-3/8	5.95	1.375	5/16 x 5/32	3.250	5	10.5	260.13
S1-02807229700	2VP68X1-3/8	6.55	1.375	5/16 x 5/32	3.250	5	12.3	287.95
S1-02808757700	2VP75X1-3/8	7.50	1.375	5/16 x 5/32	3.250	5	16.5	604.98
S1-02808828700	2VP60X1-3/8	6.00	1.375	5/16 x 5/32	3.250	5	10.2	263.95
S1-02809993700	2VP75X1-5/8	7.50	1.625	3/8 x 3/16	3.250	5	16.3	661.28
S1-02812780700	2VP71X1-5/8	7.10	1.625	3/8 x 3/16	3.250	5	14.4	390.56

Sheaves

2VP SERIES

Two Groove Variable Pitch Sheaves for "3L", "4L", "5L", "A", "B", & "5V" Belts

SOURCE 1 PART NO.	DIAMETERS PITCH (P.D.)															
	"3L" BELTS				"4L" OR "A" BELTS				"5L" OR "B" BELTS				"5V" BELTS			
	MIN PITCH	TURNS OPEN	MAX PITCH	TURNS OPEN	MIN PITCH	TURNS OPEN	MAX PITCH	TURNS OPEN	MIN PITCH	TURNS OPEN	MAX PITCH	TURNS OPEN	MIN PITCH	TURNS OPEN	MAX PITCH	TURNS OPEN
S1-02804762700	3.9	4	4.7	0	4.2	5	5.2	0	4.4	6	5.4	1	—	—	—	—
S1-02808828700	—	—	—	—	4.4	5	5.4	0	4.7	6	5.9	0	4.7	6	5.9	0
S1-02809351700	—	—	—	—	4.4	5	5.4	0	4.7	6	5.9	0	4.7	6	5.9	0
S1-02805447700	—	—	—	—	4.4	5	.4	0	4.7	6	5.9	0	4.7	6	5.9	0
S1-02807229700	—	—	—	—	4.9	5	5.9	0	5.2	6	6.4	0	5.2	6	6.4	0
S1-02812780700	—	—	—	—	5.5	5	6.5	0	5.8	6	6.6	0	5.8	6	7.0	0
S1-02808757700	—	—	—	—	5.9	5	6.9	0	6.2	6	7.4	0	6.2	6	7.4	0
S1-02809993700	—	—	—	—	5.9	6	6.9	0	6.2	6	7.4	0	6.2	6	7.4	0

2VP SERIES

Single Groove Variable Pitch Sheaves for use with "3L", "4L", "5L", "A" & "B" Belts



Features:

- Painted, machined cast iron or steel construction
- Furnished with standard keyseats
- Furnished with hollow head set screws
- Do not use "VL" & "VM" sheaves with gripnotch belts

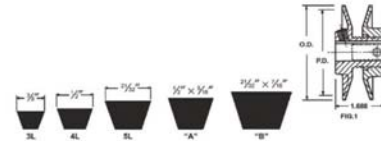

SOURCE 1 PART NO.	INDUSTRY STANDARD SHEAVE NO.	DIAMETERS		FIG	WT. LBS.	MLP \$
		O.D.	BORE DIA			
S1-02804764700	1VL44X7/8	4.15	.875	1	1.9	58.40
S1-02804807700	1VM50X7/8	4.75	.875	1	1.9	79.25
S1-02806564700	1VL44X5/8	4.15	.625	1	1.9	70.48
S1-02812361700	1VL40X5/8	3.75	.625	1	1.7	135.10
S1-02812385700	1VL40X7/8	3.75	.875	1	1.7	33.26
S1-02812781700	1VL34X1/2	3.15	.500	1	1.2	86.47

SOURCE 1 PART NO.	DIAMETERS PITCH (P.D.)											
	"3L" BELTS				"4L" OR "A" BELTS				"5L" OR "B" BELTS			
	MIN PITCH	TURNS OPEN	MAX PITCH	TURNS OPEN	MIN PITCH	TURNS OPEN	MAX PITCH	TURNS OPEN	MIN PITCH	TURNS OPEN	MAX PITCH	TURNS OPEN
S1-02812781700	1.7	4	2.5	0	1.9	5	2.9	0	2.4	5	3.2	1
S1-02812361700	2.3	4	3.1	0	2.4	5	3.4	0	2.7	6	3.7	1
S1-02812385700	2.3	4	3.1	0	2.4	5	3.8	0	2.7	6	3.7	1
S1-02806564700	2.7	4	3.5	0	2.8	5	3.8	0	3.1	6	4.1	1
S1-02804764700	2.7	4	3.5	0	2.8	5	4.4	0	3.1	6	4.1	1
S1-02804807700	3.3	4	4.1	0	3.4	5	5.0	0	3.7	6	4.7	1

Bushings

SPLIT TAPER BUSHINGS



Features:

- Malleable iron, furnished with standard keyseat and hollow head set screw

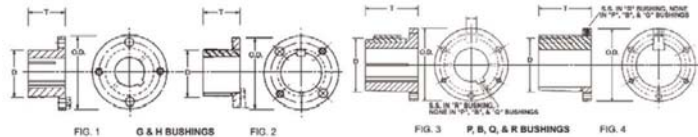

SOURCE 1 PART NO.	INDUSTRY STANDARD SHEAVE NO.	DIAMETERS					KEYSEAT	NO OF CAPSCREWS	CAPSCREWS SIZE	WRENCH TORQUE IN LBS	FIG	WEIGHT LBS	MLP \$
		BORE	O.D.	T	"D" LG. END	"D" SM. END							
S1-02808617700	H X 1-3/16	1.188	2.500	1.250	1.625	1.570	1/4 x 1/8	2	1/4 x 3/4	95	1	0.8	61.12
S1-02812064700	P1 X 1-5/8	1.625	3.000	1.937	1.937	1.855	3/8 x 3/16	3	5/16 x 1	192	4	1.3	50.75
S1-02812082700	B X 1-5/8	1.625	3.687	1.937	2.625	2.557	3/8 x 3/16	3	5/16 x 1-1/4	192	3	1.8	61.35
S1-02812306700	B X 2-7/16	2.438	3.687	1.937	2.625	2.557	5/8 x 5/16	3	5/16 x 1-1/4	192	4	1.8	56.80
S1-02812338700	B X 2-3/16	2.188	3.687	1.937	2.625	2.557	1/2 x 1/4	3	5/16 x 1-1/4	192	4	1.8	62.82
S1-02812374700	H X 1-7/16	1.438	2.500	1.250	1.625	1.570	3/8 x 3/16	2	1/4 x 3/4	95	2	0.8	28.10
S1-02812785700	P1 X 1-1/8	1.125	3.000	1.937	1.937	1.855	1/4 x 1/8	3	5/16 x 1	192	3	1.3	87.92
S1-02814752000	H X 1-3/8	1.375	2.500	1.250	1.625	1.570	5/16 x 5/32	2	1/4 x 3/4	95	1	0.8	32.00

Source 1 V-Belts

ACCU-LINK ADJUSTABLE V-BELTS



SOURCE 1 PART NO.	DESCRIPTION	MLP \$
S1-3L-LINK-5	BELT,DRIVE,3L,ACCU-LINK,5 FOOT	87.61
S1-A-LINK-25	BELT,DRIVE,A,ACCU-LINK,25 FOOT	365.39
S1-A-LINK-5	BELT,DRIVE,A,ACCU-LINK,5 FOOT	76.35
S1-B-LINK-5	BELT,DRIVE,B,ACCU-LINK,5 FOOT	106.67
S1-B-LINK-6	BELT,DRIVE,B,ACCU-LINK,6 FOOT	106.67

MULTI-PLUS V-BELTS



New dual belt brand on MULTI-PLUS belts clearly identifies both RMA classical part number and dimensionally equivalent FHP number. MULTI-PLUS allows consolidation of existing classical and FHP belt sizes into a single line that will handle both drive applications thus reducing inventory.

Dimensions: width x thickness.

Optimum blends of synthetic rubbers combined with a unique cord treating process results in a belt able to serve a dual purpose while offering more versatility and value.

SOURCE 1 PART NO.	INDUSTRY STANDARD BELT NO	OUTSIDE LENGTH (INCHES)	MLP \$
S1-A15	A15/4L170	17	6.04
S1-A16	A16/4L180	18	5.97
S1-A17	A17/4L190	19	6.04
S1-A18	A18/4L200	20	6.04
S1-A19	A19/4L210	21	6.07
S1-A20	A20/4L220	22	6.07
S1-A21	A21/4L230	23	6.14
S1-A22	A22/4L240	24	6.14
S1-A23	A23/4L250	25	6.22
S1-A24	A24/4L260	26	6.25
S1-A25	A25/4L270	27	6.29
S1-A26	A26/4L280	28	6.29
S1-A27	A27/4L290	29	6.40
S1-A28	A28/4L300	30	7.03
S1-A29	A29/4L310	31	7.14
S1-A30	A30/4L320	32	6.77
S1-A31	A31/4L330	33	6.77
S1-A32	A32/4L340	34	6.84
S1-A33	A33/4L350	35	7.00
S1-A34	A34/4L360	36	7.07
S1-A35	A35/4L370	37	7.81
S1-A36	A36/4L380	38	7.73
S1-A37	A37/4L390	39	7.81
S1-A38	A38/4L400	40	7.73
S1-A39	A39/4L410	41	8.69
S1-A40	A40/4L420	42	8.10
S1-A41	A41/4L430	43	8.79
S1-A42	A42/4L440	44	8.24
S1-A43	A43/4L450	45	9.13
S1-A44	A44/4L460	46	8.50
S1-A45	A45/4L470	47	8.61
S1-A46	A46/4L480	48	9.37
S1-A47	A47/4L490	49	8.83
S1-A48	A48/4L500	50	8.90
S1-A49	A49/4L510	51	9.19
S1-A50	A50/4L520	52	9.34
S1-A51	A51/4L530	53	9.90
S1-A52	A52/4L540	54	9.51
S1-A53	A53/4L550	55	9.38
S1-A54	A54/4L560	56	10.37
S1-A55	A55/4L570	57	9.60
S1-A56	A56/4L580	58	9.83
S1-A57	A57/4L590	59	9.93
S1-A58	A58/4L600	60	9.98
S1-A59	A59/4L610	61	10.01
S1-A60	A60/4L620	62	10.52
S1-A61	A61/4L630	63	11.13
S1-A62	A62/4L640	64	10.34
S1-A63	A63/4L650	65	10.63
S1-A64	A64/4L660	66	10.74
S1-A65	A65/4L670	67	10.86
S1-A66	A66/4L680	68	10.86
S1-A67	A67/4L690	69	11.01
S1-A68	A68/4L700	70	11.08
S1-A69	A69/4L710	71	11.55

Source 1 V-Belts

MULTI-PLUS V-BELTS

SOURCE 1 PART NO.	INDUSTRY STANDARD BELT NO	OUTSIDE LENGTH (INCHES)	MLP \$
S1-A70	A70/4L720	72	11.55
S1-A71	A71/4L730	73	11.59
S1-A72	A72/4L740	74	11.66
S1-A73	A73/4L750	75	11.77
S1-A74	A74/4L760	76	12.82
S1-A75	A75/4L770	77	12.04
S1-A76	A76/4L780	78	12.22
S1-A77	A77/4L790	79	12.29
S1-A78	A78/4L800	80	12.51
S1-A79	A79/4L810	81	12.69
S1-A80	A80/4L820	82	12.95
S1-A81	A81/4L830	83	13.21
S1-A82	A82/4L840	84	13.32
S1-A83	A83/4L850	85	13.58
S1-A84	A84/4L860	86	13.69
S1-A85	A85/4L870	87	13.95
S1-A86	A86/4L880	88	14.13
S1-A87	A87/4L890	89	14.31
S1-A88	A88/4L900	90	14.49
S1-A89	A89/4L910	91	14.72
S1-A90	A90/4L920	92	14.89
S1-A91	A91/4L930	93	15.09
S1-A92	A92/4L940	94	15.24
S1-A93	A93/4L950	95	15.34
S1-A94	A94/4L960	96	15.52
S1-A95	A95/4L970	97	15.67
S1-A96	A96/4L980	98	15.82
S1-A97	A97/4L990	99	16.01
S1-A98	A98/4L1000	100	16.19
S1-B21	B21/5L240	24	7.32
S1-B22	B22/5L250	25	8.17
S1-B23	B23/5L260	26	8.46
S1-B24	B24/5L270	27	8.68
S1-B25	B25/5L280	28	8.98
S1-B26	B26/5L290	29	9.06
S1-B27	B27/5L300	30	9.09
S1-B28	B28/5L310	31	9.16
S1-B29	B29/5L320	32	9.23
S1-B30	B30/5L330	33	9.27
S1-B31	B31/5L340	34	9.38
S1-B32	B32/5L350	35	9.41
S1-B33	B33/5L360	36	9.57
S1-B34	B34/5L370	37	9.57
S1-B35	B35/5L380	38	10.38
S1-B36	B36/5L390	39	9.83
S1-B37	B37/5L400	40	10.30
S1-B38	B38/5L410	41	10.63
S1-B39	B39/5L420	42	10.93
S1-B40	B40/5L430	43	11.55
S1-B41	B41/5L440	44	11.08
S1-B42	B42/5L450	45	11.55
S1-B43	B43/5L460	46	11.66
S1-B44	B44/5L470	47	11.66
S1-B45	B45/5L480	48	12.04
S1-B46	B46/5L490	49	12.51
S1-B47	B47/5L500	50	12.58
S1-B48	B48/5L510	51	12.95
S1-B49	B49/5L520	52	14.16
S1-B50	B50/5L530	53	13.21
S1-B51	B51/5L540	54	13.43
S1-B52	B52/5L550	55	13.46
S1-B53	B53/5L560	56	13.69
S1-B54	B54/5L570	57	13.86
S1-B55	B55/5L580	58	13.98
S1-B56	B56/5L590	59	14.06
S1-B57	B57/5L600	60	14.13
S1-B58	B58/5L610	61	14.17
S1-B59	B59/5L620	62	14.38
S1-B60	B60/5L630	63	15.09
S1-B61	B61/5L640	64	14.68
S1-B62	B62/5L650	65	14.89
S1-B63	B63/5L660	66	14.98

Source 1 V-Belts

MULTI-PLUS V-BELTS

SOURCE 1 PART NO.	INDUSTRY STANDARD BELT NO	OUTSIDE LENGTH (INCHES)	MLP \$
S1-B63	B63/5L660	66	14.98
S1-B64	B64/5L670	67	15.09
S1-B65	B65/5L680	68	16.39
S1-B66	B66/5L690	69	15.52
S1-B67	B67/5L700	70	15.67
S1-B68	B68/5L710	71	15.85
S1-B69	B69/5L720	72	16.55
S1-B70	B70/5L730	73	16.81
S1-B71	B71/5L740	74	16.95
S1-B72	B72/5L750	75	17.12
S1-B73	B73/5L760	76	17.19
S1-B74	B74/5L770	77	17.30
S1-B75	B75/5L780	78	17.33
S1-B76	B76/5L790	79	17.70
S1-B77	B77/5L800	80	18.03
S1-B78	B78/5L810	81	18.07
S1-B79	B79/5L820	82	18.29
S1-B80	B80/5L830	83	18.62
S1-B81	B81/5L840	84	18.76
S1-B82	B82/5L850	85	18.98
S1-B83	B83/5L860	86	19.36
S1-B84	B84/5L870	87	19.43
S1-B85	B85/5L880	88	19.72
S1-B86	B86/5L890	89	19.90
S1-B87	B87/5L900	90	20.13
S1-B88	B88/5L910	91	20.31
S1-B89	B89/5L920	92	20.46
S1-B90	B90/5L930	93	20.64
S1-B91	B91/5L940	94	20.86
S1-B92	B92/5L950	95	21.04
S1-B93	B93/5L960	96	21.24
S1-B94	B94/5L970	97	21.45
S1-B95	B95/5L980	98	21.63
S1-B96	B96/5L990	99	21.82
S1-B97	B97/5L1000	100	22.62
S1-B100	B100/5L1030	103	22.62
S1-B101	B101/5L1040	104	22.62
S1-B103	B103/5L1060	106	22.62
S1-B108	B108/5L1110	111	22.62
S1-B116	B116/5L1190	119	22.62
S1-B120	B120/5L1230	123	22.62
S1-B124	B124/5L1270	127	22.62
S1-B133	B133/5L1420	142	22.62
S1-B136	B136/5L1390	139	22.62
S1-B144	B144/5L1470	147	22.62
S1-B150	B150/5L1530	153	22.62
S1-B158	B158/5L1610	161	22.62
S1-B162	B162/5L1650	165	22.62

MOTORS & MOTOR ACCESSORIES

NARROW, COGGED, RAW EDGE, DEEP WEDGE V-BELTS

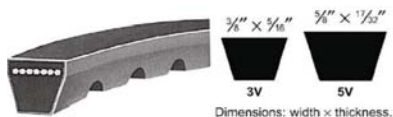

Features:

- Raw edge, cogged construction increases power transmission
- Oil & heat resistant
- Dissipates static

SOURCE 1 PART NO.	INDUSTRY STANDARD BELT NO	OUTSIDE LENGTH (INCHES)	MLP \$
S1-3VX900	3VX900	90	27.77
S1-5VX1000	5VX1000	100	71.16
S1-5VX670	5VX670	67	46.83
S1-5VX680	5VX680	68	49.78
S1-5VX710	5VX710	71	49.78
S1-5VX780	5VX780	78	56.10
S1-5VX800	5VX800	80	56.10
S1-5VX840	5VX840	84	60.46
S1-5VX850	5VX850	85	60.46
S1-5VX860	5VX860	86	62.77
S1-5VX950	5VX950	95	67.40

Source 1 V-Belts

FRACTIONAL HORSEPOWER V-BELTS

3L Series

SOURCE 1 PART NO.	INDUSTRY STANDARD BELT NO	OUTSIDE LENGTH (INCHES)	MLP \$
S1-3L180	3L180	18	5.67
S1-3L200	3L200	20	5.67
S1-3L210	3L210	21	5.67
S1-3L220	3L220	22	5.67
S1-3L230	3L230	23	5.67
S1-3L250	3L250	25	5.67

MULTI-COGGED V-BELTS



Features:

- Raw edge, cogged construction
- More horsepower in less space
- Notches are molded extra deep
- Oil and heat resistant

SOURCE 1 PART NO.	INDUSTRY BELT NO	MLP \$
S1-AX22	AX22	11.59
S1-AX23	AX23	11.59
S1-AX24	AX24	11.59
S1-AX25	AX25	11.59
S1-AX26	AX26	11.59
S1-AX27	AX27	11.96
S1-AX28	AX28	11.59
S1-AX29	AX29	11.59
S1-AX30	AX30	12.36
S1-AX31	AX31	12.51
S1-AX32	AX32	13.13
S1-AX33	AX33	12.95
S1-AX34	AX34	13.21
S1-AX35	AX35	13.39
S1-AX36	AX36	13.65
S1-AX37	AX37	14.03
S1-AX38	AX38	14.31
S1-AX39	AX39	14.79
S1-AX40	AX40	14.79
S1-AX41	AX41	15.09
S1-AX42	AX42	15.34
S1-AX43	AX43	15.60
S1-AX44	AX44	15.85
S1-AX45	AX45	15.89
S1-AX46	AX46	16.09
S1-AX47	AX47	16.41
S1-AX48	AX48	16.41
S1-AX49	AX49	16.78
S1-AX50	AX50	16.78
S1-AX51	AX51	17.00
S1-AX52	AX52	17.15
S1-AX53	AX53	17.33
S1-AX54	AX54	17.58
S1-AX55	AX55	17.84
S1-AX56	AX56	17.95
S1-AX57	AX57	18.25
S1-AX58	AX58	18.29
S1-AX59	AX59	18.47
S1-AX60	AX60	18.76
S1-AX61	AX61	19.21
S1-AX62	AX62	19.21
S1-AX63	AX63	19.36
S1-AX64	AX64	19.61
S1-AX65	AX65	20.13
S1-AX66	AX66	20.13
S1-AX67	AX67	20.31
S1-AX68	AX68	20.53
S1-AX69	AX69	21.38
S1-AX70	AX70	21.42
S1-AX71	AX71	21.59
S1-AX72	AX72	21.89

Source 1 V-Belts

MULTI-COGGED V-BELTS

SOURCE 1 PART NO.	INDUSTRY BELT NO	MLP \$
S1-AX73	AX73	21.93
S1-AX75	AX75	22.34
S1-AX76	AX76	22.55
S1-AX78	AX78	23.40
S1-AX80	AX80	24.13
S1-AX84	AX84	25.64
S1-AX85	AX85	25.87
S1-AX86	AX86	26.15
S1-AX90	AX90	27.63
S1-AX92	AX92	28.25
S1-AX96	AX96	29.48
S1-BX30	BX30	15.31
S1-BX31	BX31	15.82
S1-BX32	BX32	17.91
S1-BX33	BX33	17.91
S1-BX34	BX34	17.91
S1-BX35	BX35	17.91
S1-BX36	BX36	18.43
S1-BX37	BX37	19.18
S1-BX38	BX38	19.61
S1-BX39	BX39	19.61
S1-BX40	BX40	20.53
S1-BX41	BX41	21.00
S1-BX42	BX42	21.42
S1-BX43	BX43	21.93
S1-BX44	BX44	22.27
S1-BX45	BX45	23.23
S1-BX46	BX46	23.23
S1-BX47	BX47	23.40
S1-BX48	BX48	23.95
S1-BX49	BX49	24.65
S1-BX50	BX50	24.65
S1-BX51	BX51	25.02
S1-BX52	BX52	25.25
S1-BX53	BX53	25.43
S1-BX54	BX54	27.80
S1-BX55	BX55	25.94
S1-BX56	BX56	26.05
S1-BX57	BX57	26.42
S1-BX58	BX58	26.42
S1-BX59	BX59	26.60
S1-BX60	BX60	26.74
S1-BX61	BX61	27.11
S1-BX62	BX62	27.49
S1-BX63	BX63	27.82
S1-BX64	BX64	28.25
S1-BX65	BX65	28.59
S1-BX66	BX66	28.96
S1-BX67	BX67	29.17
S1-BX68	BX68	29.48
S1-BX69	BX69	30.27
S1-BX70	BX70	30.27
S1-BX71	BX71	30.65
S1-BX72	BX72	30.65
S1-BX73	BX73	34.69
S1-BX74	BX74	32.15
S1-BX75	BX75	32.15
S1-BX76	BX76	33.04
S1-BX77	BX77	33.04
S1-BX78	BX78	36.11
S1-BX79	BX79	33.88
S1-BX80	BX80	34.36
S1-BX81	BX81	34.81
S1-BX82	BX82	35.66
S1-BX83	BX83	35.99
S1-BX84	BX84	36.58
S1-BX85	BX85	36.58
S1-BX86	BX86	38.37
S1-BX87	BX87	37.45

MOTORS &
MOTOR ACCESSORIES

Source 1 V-Belts

MULTI-COGGED V-BELTS

SOURCE 1 PART NO.	INDUSTRY BELT NO	MLP \$
S1-BX88	BX88	37.49
S1-BX89	BX89	37.93
S1-BX90	BX90	38.33
S1-BX91	BX91	39.26
S1-BX92	BX92	39.62
S1-BX93	BX93	40.22
S1-BX94	BX94	40.62
S1-BX95	BX95	41.02
S1-BX96	BX96	41.53
S1-BX97	BX97	41.94
S1-BX98	BX98	42.10
S1-BX99	BX99	42.61
S1-BX100	BX100	42.83
S1-BX103	BX103	43.74
S1-BX105	BX105	44.63
S1-BX108	BX108	46.32
S1-BX112	BX112	48.16
S1-BX113	BX113	48.53
S1-BX115	BX115	49.19
S1-BX116	BX116	49.49
S1-BX120	BX120	50.88
S1-BX124	BX124	52.65

Installation Accessories

GAS ACCESSORIES

Polypropylene Venting System



Polyflue is a simple and complete venting system providing the ultimate installation flexibility. Polyflue is made of flame retardant polypropylene (PPs), a credible and superior material for condensing gas fired heating appliances when compared to PVC/CPVC. It is a safe and economical approach to high efficiency heating appliance venting.



Single Wall, Rigid Pipe

SOURCE 1 PART NO.	DESCRIPTION	ORDER MULTIPLE	MLP \$
S1-PF-832001	2PF-10, 10"L PIPE	20	17.15
S1-PF-832012	2PF-20, 20"L PIPE	10	20.56
S1-PF-832002	2PF-39, 39"L PIPE	10	26.12
S1-PF-832004	2PF-79, 79"L PIPE	10	48.46
S1-PF-832010	2PF-10UV, 10"L PIPE UV-WHT	20	21.00
S1-PF-832003	2PF-39UV, 39"L PIPE UV-WHT	10	26.12
S1-PF-833001	3PF-10, 10"L PIPE	20	23.84
S1-PF-833022	3PF-20, 20"L PIPE	10	28.41
S1-PF-833002	3PF-39, 39"L PIPE	10	38.01
S1-PF-833004	3PF-79, 79"L PIPE	6	67.18
S1-PF-833012	3PF-10UV, 10"L PIPE UV-WHT	20	23.84
S1-PF-833003	3PF-39UV, 39"L PIPE UV-WHT	10	38.01
S1-PF-834001	4PF-10, 10"L PIPE	30	33.74
S1-PF-834026	4PF-20, 20"L PIPE	30	38.16
S1-PF-834002	4PF-39, 39"L PIPE	35	49.85
S1-PF-834004	4PF-79, 79"L PIPE	3	101.69
S1-PF-834012	4PF-10UV, 10"L PIPE UV-WHT	30	33.74
S1-PF-834003	4PF-39UV, 39"L PIPE UV-WHT	35	63.94

90° Elbow

SOURCE 1 PART NO.	DESCRIPTION	ORDER MULTIPLE	MLP \$
S1-PF-832008	2PF-90, 90 ELBOW	10	17.63
S1-PF-833008	3PF-90, 90 ELBOW	10	24.65
S1-PF-834008	4PF-90, 90 ELBOW	6	35.03
S1-PF-832009	2PF-90UV, 90 ELB UV-WHT	10	18.25
S1-PF-833009	3PF-90UV, 90 ELB UV-WHT	10	24.65
S1-PF-834009	4PF-90UV, 90 ELB UV-WHT	6	35.03

INSTALLATION
SUPPLIES

Installation Accessories

GAS ACCESSORIES

Polypropylene Venting System

45° Elbow

SOURCE 1 PART NO.	DESCRIPTION	ORDER MULTIPLE	MLP \$
S1-PF-832006	2PF-45, 45 ELBOW	10	18.94
S1-PF-833006	3PF-45, 45 ELBOW	10	24.65
S1-PF-834006	4PF-45, 45 ELBOW	6	32.50
S1-PF-832007	2PF-45UV, 45 ELB UV-WHT	10	19.69
S1-PF-833007	3PF-45UV, 45 ELB UV-WHT	10	24.65
S1-PF-834007	4PF-45UV, 45 ELB UV-WHT	6	32.50

Tee

SOURCE 1 PART NO.	DESCRIPTION	ORDER MULTIPLE	MLP \$
S1-PF-832011	2PF-T, TEE	1	33.60
S1-PF-833011	3PF-T, TEE	10	27.70
S1-PF-834011	4PF-T, TEE	1	41.84

Tee Cap

SOURCE 1 PART NO.	DESCRIPTION	ORDER MULTIPLE	MLP \$
S1-PF-832013	2PF-TC, T-CAP	1	58.68
S1-PF-833013	3PF-TC, T-CAP	1	48.16
S1-PF-834013	4PF-TC, T-CAP	1	55.59

Tee Cap with Drain

SOURCE 1 PART NO.	DESCRIPTION	ORDER MULTIPLE	MLP \$
S1-PF-832014	2PF-TCD, T-CAP DRAIN	1	51.47
S1-PF-833014	3PF-TCD, T-CAP DRAIN	1	64.20
S1-PF-834014	4PF-TCD, T-CAP DRAIN	1	71.48

Condensate Drain Tube

SOURCE 1 PART NO.	DESCRIPTION	ORDER MULTIPLE	MLP \$
S1-PF-833100	PF-CDT, COND DRN TUBE, 3/4"X10FT	1	119.11

Inline Condensate Drain

SOURCE 1 PART NO.	DESCRIPTION	ORDER MULTIPLE	MLP \$
S1-PF-833010	3PF-CD, INLINE COND DRAIN	1	194.34
S1-PF-834010	4PF-CD, INLINE COND DRAIN	1	111.01

Test Port

SOURCE 1 PART NO.	DESCRIPTION	ORDER MULTIPLE	MLP \$
S1-PF-832005	2PF-TP, TEST PORT	1	33.22
S1-PF-833005	3PF-TP, TEST PORT	1	45.47
S1-PF-834005	4PF-TP, TEST PORT	1	72.04

Increaser

SOURCE 1 PART NO.	DESCRIPTION	ORDER MULTIPLE	MLP \$
S1-PF-832015	2PF-2I3, 2"-3" INCREASER	6	22.20
S1-PF-833015	3PF-3I4, 3"-4" INCREASER	10	32.60

Reducer

SOURCE 1 PART NO.	DESCRIPTION	ORDER MULTIPLE	MLP \$
S1-PF-833016	3PF-3R2, 3"-2" REDUCER	1	30.98
S1-PF-834015	4PF-4R3, 4"-3" REDUCER	1	59.46

Vertical Concentric Termination

SOURCE 1 PART NO.	DESCRIPTION	ORDER MULTIPLE	MLP \$
S1-PF-832022	2PF-VCT, VERT CONC TERM BLACK	1	127.15
S1-PF-833023	3PF-VCT, VERT CONC TERM BLACK	1	165.16

Horizontal Concentric Termination

SOURCE 1 PART NO.	DESCRIPTION	ORDER MULTIPLE	MLP \$
S1-PF-832023	2PF-HCT, HORIZ CONC TERM WHT	1	60.49
S1-PF-833024	3PF-HCT, HORIZ CONC TERM WHT	1	80.75
S1-PF-834021	4PF-HCT, HORIZ CONC TERM WHT	1	332.19

Installation Accessories

GAS ACCESSORIES

Polypropylene Venting System

Twin Pipe to Concentric Adapter

SOURCE 1 PART NO.	DESCRIPTION	ORDER MULTIPLE	MLP \$
S1-PF-832024	2PF-CTA, TWIN PIPE TO CONC TERM ADPTR	1	79.79
S1-PF-833025	3PF-CTA, TWIN PIPE TO CONC TERM ADPTR	1	83.30
S1-PF-834022	4PF-CTA, TWIN PIPE TO CONC TERM ADPTR	1	131.54

Flex Pipe Roll

SOURCE 1 PART NO.	DESCRIPTION	ORDER MULTIPLE	MLP \$
S1-PF-832039	2PF-FLEX, FLEXIBLE PIPE ROLL, 66 FT	1	571.10
S1-PF-833039	3PF-FLEX, FLEXIBLE PIPE ROLL, 66 FT	1	800.03
S1-PF-834039	4PF-FLEX, FLEXIBLE PIPE ROLL, 66FT	1	1018.65

Flex Kit

SOURCE 1 PART NO.	DESCRIPTION	ORDER MULTIPLE	MLP \$
S1-PF-832051	2PF-FLEX-KIT, MASONRY RE-LINER KIT	1	346.59
S1-PF-833051	3PF-FLEX-KIT, MASONRY RE-LINER KIT	1	361.49
S1-PF-834051	4PF-FLEX-KIT, MASONRY RE-LINER KIT	1	419.62

Flex Spacer

SOURCE 1 PART NO.	DESCRIPTION	ORDER MULTIPLE	MLP \$
S1-PF-832026	2PF-FLEX-SP, FLEX PIPE SPACER	5	10.60
S1-PF-833027	3PF-FLEX-SP, FLEX PIPE SPACER	5	9.67
S1-PF-834024	4PF-FLEX-SP, FLEX PIPE SPACER	5	16.16

Firestop, Wall Plate

SOURCE 1 PART NO.	DESCRIPTION	ORDER MULTIPLE	MLP \$
S1-PF-832044	2PF-FS, FIRESTOP	10	12.18
S1-PF-833044	3PF-FS, FIRESTOP	10	12.32
S1-PF-834044	4PF-FS, FIRESTOP	10	12.66
S1-PF-832047	2PF-WP, WALL PLATE	4	20.28
S1-PF-833047	3PF-WP, WALL PLATE	4	13.61
S1-PF-834047	4PF-WP, WALL PLATE	4	13.61
S1-PF-833045	3PF-WPC, WALL PLATE CONC	4	20.42
S1-PF-833046	4PF-WPC, WALL PLATE CONC	4	20.42

Bird Screen

SOURCE 1 PART NO.	DESCRIPTION	ORDER MULTIPLE	MLP \$
S1-PF-832050	2PF-HVST, SCRNM TERM, HORIZ/VERT	4	10.60
S1-PF-833050	3PF-HVST, SCRNM TERM, HORIZ/VERT	4	13.95
S1-PF-834050	4PF-HVST, SCRNM TERM, HORIZ/VERT	4	17.33

B-Vent Re-line Storm Collar

SOURCE 1 PART NO.	DESCRIPTION	ORDER MULTIPLE	MLP \$
S1-PF-832052	2PF-BVSC, FLEX BVNT RELN SUPPT COLL	4	30.87
S1-PF-833052	3PF-BVSC, FLEX BVNT RELN SUPPT COLL	4	32.23
S1-PF-834052	4PF-BVSC, FLEX BVNT RELN SUPPT COLL	4	35.76

PVC to Poly Adapter

SOURCE 1 PART NO.	DESCRIPTION	ORDER MULTIPLE	MLP \$
S1-PF-833040	3PF-PVC-PF, ADPTR PVC TO PF	4	95.03
S1-PF-834040	4PF-PVC-PF, ADPTR PVC TO PF	4	95.03

Nominal to Poly Adapter

SOURCE 1 PART NO.	DESCRIPTION	ORDER MULTIPLE	MLP \$
S1-PF-833041	3PF-NOM-PF, ADPTR NOM TO PF	4	48.53
S1-PF-834041	4PF-NOM-PF, ADPTR NOM TO PF	4	48.53

EZ Seal to Poly Adapter

SOURCE 1 PART NO.	DESCRIPTION	ORDER MULTIPLE	MLP \$
S1-PF-833042	3PF-EZ-PF, ADPTR EZ SEAL TO PF	4	55.04
S1-PF-834042	4PF-EZ-PF, ADPTR EZ SEAL TO PF	4	59.82

Installation Accessories

GAS ACCESSORIES

Polypropylene Venting System

Poly to EZ Seal Adapter

SOURCE 1 PART NO.	DESCRIPTION	ORDER MULTIPLE	MLP \$
S1-PF-833043	3PF-EZ, ADPTR PF TO EZ SEAL	4	50.18
S1-PF-834043	4PF-EZ, ADPTR PF TO EZ SEAL	4	58.94

Gaskets - Straight Pipe / Flex Pipe

SOURCE 1 PART NO.	DESCRIPTION	ORDER MULTIPLE	MLP \$
S1-PF-832019	2PF-GKV, 2" REPL PIPE/FLEX GSKT	10	13.10
S1-PF-833056	3PF-GKVS, 3" REPL PIPE GSKT	10	13.95
S1-PF-833020	3PF-GKV, 3" REPL FLEX GSKT	10	13.95
S1-PF-834018	4PF-GKV, 4" REPL PIPE/FLEX GSKT	10	20.90

Gaskets - Elbows & Tees

SOURCE 1 PART NO.	DESCRIPTION	ORDER MULTIPLE	MLP \$
S1-PF-832020	2PF-GKETV, 2" REPL ELB GSKT	10	13.10
S1-PF-833021	3PF-GKETV, 3" REPL ELB GSKT	10	13.95
S1-PF-834019	4PF-GKETV, 4" REPL ELB GSKT	10	20.90

Horizontal Support

SOURCE 1 PART NO.	DESCRIPTION	ORDER MULTIPLE	MLP \$
S1-PF-832045	PF-HS, 2"-3" HORIZ SUPPT	8	9.13
S1-PF-834045	4PF-HS, 3"-4" HORIZ SUPPT	8	9.46
S1-PF-833054	3PF-HCTHS, HORIZ CONC SUPPT	4	10.86
S1-PF-834054	4PF-HCTHS, HORIZ CONC SUPPT	4	11.19

Wall Strap

SOURCE 1 PART NO.	DESCRIPTION	ORDER MULTIPLE	MLP \$
S1-PF-832046	PF-WS, 2"-3" WALL STRAP	8	28.14
S1-PF-834046	4PF-WS, 3"-4" WALL STRAP	8	29.17
S1-PF-833053	3PF-VCTWB, VERT CONC WALL STRAP	4	31.57

Locking Band

SOURCE 1 PART NO.	DESCRIPTION	ORDER MULTIPLE	MLP \$
S1-PF-832040	PF-LB, 2"- 3", JOINT LOCK BND*	12	6.04
S1-PF-834049	4PF-LB, 3"-4", JOINT LOCK BND*	12	6.25

Roof Flashings - Aluminum

SOURCE 1 PART NO.	DESCRIPTION	ORDER MULTIPLE	MLP \$
S1-PF-852190	2" SHINGLE FLASHING ALUMINUM	12	12.40
S1-PF-852290	3" SHINGLE FLASHING ALUMINUM	12	13.65
S1-PF-852390	4" SHINGLE FLASHING ALUMINUM	12	16.60

Roof Flashings - Thermoplastic

SOURCE 1 PART NO.	DESCRIPTION	ORDER MULTIPLE	MLP \$
S1-PF-853190	2" SHINGLE FLASHING THERMOPLASTIC	12	11.15
S1-PF-853290	3" SHINGLE FLASHING THERMOPLASTIC	12	12.11
S1-PF-853390	4" SHINGLE FLASHING THERMOPLASTIC	12	14.54

Roof Flashings - Galvalume® Flashing

SOURCE 1 PART NO.	DESCRIPTION	ORDER MULTIPLE	MLP \$
S1-PF-BV4ARF	4" B-VENT ADJ. ROOF FLASHING	1	72.23
S1-PF-BV4SRF	4" B-VENT STEEP ROOF FLASHING	1	78.00
S1-PF-BV4SC	4" B-VENT STORM COLLAR	8	76.18

Sealant

SOURCE 1 PART NO.	DESCRIPTION	ORDER MULTIPLE	MLP \$
S1-PF-7000RTV	SEALANT, HITEMP SILICONE RTV, 2.8 OZ	1	59.61

Condensing Furnace Concentric Vent Terminal Kits



The S1-1CT0302 and S1-1CT-0303 concentric vent cap accessories are approved for application with UPG condensing furnaces. Each kit consists of a top cap, inner and outer flues, and a 45-degree mating connector. Kits with part numbers ending in "-636" are ULC-S636 certified, to comply with Canadian regulatory requirements.

SOURCE 1 PART NO.	DESCRIPTION	MLP \$
S1-1CT0302	2-INCH CONCENTRIC VENT TERMINAL KIT	59.84
S1-1CT0302-636	2-INCH CONCENTRIC VENT TERMINAL KIT, ULC-S636	101.33
S1-1CT0303	3-INCH CONCENTRIC VENT TERMINAL KIT	93.62
S1-1CT0303-636	3-INCH CONCENTRIC VENT TERMINAL KIT, ULC-S636	128.87

Installation Accessories

GAS ACCESSORIES

Condensing Furnace Horizontal Vent Terminal Kits



Approved for use with UPG condensing furnaces. Each kit contains a vent base, vent cap, and four 2" screws. These kits are only for use with sidewall venting for condensing furnaces. Kits with part numbers ending in "-636" are ULS-S636 certified, to comply with Canadian regulatory requirements.

SOURCE 1 PART NO.	DESCRIPTION	MLP \$
S1-1HT0901	3" HORIZONTAL VENT KIT	35.76
S1-1HT0901-636	3" HORIZONTAL VENT KIT, ULS-S636	50.54
S1-1HT0902	2" HORIZONTAL VENT KIT	36.62
S1-1HT0902-636	2" HORIZONTAL VENT KIT, ULS-S636	44.38

MOUNTING ACCESSORIES

SOURCE 1® Innerflow™ Condenser Covers

Branded as "Tag in the Bag" for SOURCE 1, York, Coleman, Luxaire, & Champion Brands



The Patented Innerflow™ Air Conditioner Cover was engineered and designed through necessity. Prior to the existence of the Innerflow™ Air Conditioner Cover, other conventional air conditioner covers on the market caused more damage than good. These conventional air conditioner covers had little or no ventilation, which in turn traps warm moist condensing air causing premature rusting of the cabinet and interior components of the covered air conditioner. Another type of cover on the market covered just the top of the air conditioner, providing plenty of ventilation but no protection from the elements or flying debris. By incorporating the Patented Innerflow™ System on our air conditioner covers you can now have a cover that completely protects your air conditioner from top to bottom without fear of damaging condensation.

The Innerflow™ System has been tested and approved by most major HVAC manufacturers and along with independent laboratories has proven that when you cover your air conditioner with the Innerflow™ Air Conditioner Cover, your air conditioner is fully protected from harsh weather, flying debris, moisture build up and damaging condensation.

Finally an air conditioner cover that does exactly what it is designed to do ... protect the consumer's investment.

SOURCE 1 PART NO.	DESCRIPTION	BASE	FITS UNIT DIMENSIONS (IN)			MLP \$
			L	W	H	
S1-CCVREA23	CVR,COND,VENTED,E-CHASSIS,A BASE,23 H	A	24	24	23.45	115.42
S1-CCVREA26	CVR,COND,VENTED,E-CHASSIS,A BASE,26 H	A	24	24	26.65	115.42
S1-CCVREA29	CVR,COND,VENTED,E-CHASSIS,A BASE,29 H	A	24	24	29.85	120.09
S1-CCVREA33	CVR,COND,VENTED,E-CHASSIS,A BASE,33 H	A	24	24	33.05	124.84
S1-CCVREA36	CVR,COND,VENTED,E-CHASSIS,A BASE,36 H	A	24	24	36.25	124.84
S1-CCVREB23	CVR,COND,VENTED,E-CHASSIS,B BASE,23 H	B	29	29	23.5	134.22
S1-CCVREB26	CVR,COND,VENTED,E-CHASSIS,B BASE,26 H	B	29.25	29.25	26.65	134.22
S1-CCVREB29	CVR,COND,VENTED,E-CHASSIS,B BASE,29 H	B	29.25	29.25	29.85	134.22
S1-CCVREB33	CVR,COND,VENTED,E-CHASSIS,B BASE,33 H	B	29.25	29.25	30.5	134.22
S1-CCVREB36	CVR,COND,VENTED,E-CHASSIS,B BASE,36 H	B	29.25	29.25	36.25	138.96
S1-CCVREC33	CVR,COND,VENTED,E-CHASSIS,C BASE,33 H	C	31.75	35.25	33.05	138.96
S1-CCVREC36	CVR,COND,VENTED,E-CHASSIS,C BASE,36 H	C	35	31.5	36.25	140.95
S1-CCVREC39	CVR,COND,VENTED,E-CHASSIS,C BASE,39 H	C	31.75	35.25	39.45	143.64
S1-CCVRED36	CVR,COND,VENTED,E-CHASSIS,D BASE,36 H	D	34.25	38	36.25	143.64
S1-CCVRED39	CVR,COND,VENTED,E-CHASSIS,D BASE,39 H	D	34.25	38	39.45	143.64
S1-CCVRED42	CVR,COND,VENTED,E-CHASSIS,D BASE,42 H	D	37.75	34	42.75	143.64

Installation Accessories

BOSS 125 MULTI SEAL BUILDING CONSTRUCTION SEALANT



BOSS® 125 Multi-Seal Building/Construction Sealant is a multipurpose, one part sealant, formulated from a hybrid polymer. This unique sealant is free from solvents, silicone, isocyanates and other hazardous raw materials. It cures on exposure to atmospheric moisture to form a highly durable flexible sealant. Multi-Seal has been formulated to offer outstanding primerless adhesion to most common building materials including vinyl, aluminum, steel, concrete, wood and glass. It can be applied and tooled under most weather conditions. This sealant is paintable with most latex base paints.



Approved as roof jack sealant in manufactured housing.

Features:

- VOC Compliant in all 50 states
- Ease of use, one-part sealant, no mixing required
- Good weatherability - virtually unaffected by sunlight, rain, snow, ozone, and temperature extremes
- Good UV resistance and color stability
- Long life reliability; cured sealant stays flexible without tearing, cracking, drying out, or becoming brittle.
- With its non slump properties, can be used in vertical, horizontal and overhead joints
- Wide temperature gunnability; can be applied in any season
- Non-yellowing and non-staining
- Non-streaking
- Paintable with most latex base paints*
- Free from solvents and isocyanates
- Bonds to Kynar 500®

SOURCE 1 PART NO.	DESCRIPTION	BOSS PART NO	MLP \$
S1-BOSS12503	SEALANT, CONSTRUCTION, MULTI-PURPOSE, 10.1 OZ, GREY	03970GY10	15.41

TOUCH UP PAINTS

SOURCE 1 PART NO.	COLOR	CAN SIZE	MLP \$
S1-51301503000	TITANIUM (SILVER)	16 OZ	79.20
S1-51301505000	CHAMPAGNE (NON-METALLIC)	16 OZ	42.79
S1-51301530000	CHAMPAGNE 2	16 OZ	52.17
S1-51301531000	TITANIUM 2	16 OZ	51.07
S1-51302881700	DESERT SAND (TAN)	16 OZ	44.13
S1-51302934000	CHAMPAGNE (METALLIC)	16 OZ	56.51

Slip-On Terminals

SLIP-ONS - COMBINATION PACK



SOURCE 1 PART NO.	DESCRIPTION	WIRE RANGE	TAB SIZE	STD PACK	MLP \$
S1-61233LX	SET OF FULLY INSULATED M/F SLIP-ONS	16-14	.250	25 PAIRS	28.45

*MLP per Standard Pack

SLIP-ONS - INSULATED FEMALE



The insulation on fully insulated slip-ons is vinyl or nylon.

SOURCE 1 PART NO.	DESCRIPTION	WIRE RANGE	TAB SIZE	STD PACK	MLP \$
S1-6218	INSULATED FEMALE SLIP-ON	16-14	.250	22	7.51
S1-6218CX	INSULATED FEMALE SLIP-ON	16-14	.250	100	27.70
S1-6218LX	INSULATED FEMALE SLIP-ON	16-14	.250	50	14.79
S1-6235CX	INSULATED FEMALE SLIP-ON	22-18	.250	100	28.03
S1-6251	INSULATED FEMALE SLIP-ON	12-10	.250	17	7.51
S1-6251LX	INSULATED FEMALE SLIP-ON	12-10	.187	50	19.83

*MLP per Standard Pack

SLIP-ONS - FULLY INSULATED FEMALE



The insulation on fully insulated slip-ons is vinyl or nylon.

SOURCE 1 PART NO.	DESCRIPTION	WIRE RANGE	TAB SIZE	STD PACK	MLP \$
S1-6229LX	FULLY INSULATED FEMALE SLIP-ON ††	22-18	.250	50	39.11
S1-6233	FULLY INSULATED FEMALE SLIP-ON	16-14	.187	14	7.51
S1-6233CX	FULLY INSULATED FEMALE SLIP-ON	16-14	.250	100	46.50

*MLP per Standard Pack

††This terminal is usually supplied vinyl and has an insulation grip.

SPADES - INSULATED



SOURCE 1 PART NO.	DESCRIPTION	WIRE RANGE	STUD	STD PACK	MLP \$
S1-60254LX	INSULATED SPADES	12-10	#8	50	17.12
S1-6227LX	INSULATED SPADES	16-14	#8	50	15.38

*MLP per Standard Pack

TAB ADAPTERS - PIGGY BACK SLIP-ONS



SOURCE 1 PART NO.	DESCRIPTION	WIRE RANGE	STD PACK	MLP \$
S1-60210CX	INSULATED PIGGY BLACK SLIP-ONS	16-14	100	57.25

*MLP per Standard Pack

Tab Adapter Terminals

TAB ADAPTERS - SINGLE FEMALE DOUBLE MALE TABS

.250 male, .250 female.



SOURCE 1 PART NO.	DESCRIPTION	TAB SIZE	STD PACK	MLP \$
S1-6211	TAB ADAPTER; 1 FEMALE, 1 MALE; WYE	.250	27	8.28
S1-6211CX	TAB ADAPTER; 1 FEMALE, 1 MALE; WYE	.250	100	27.77
S1-6212	TAB ADAPTER; 1 FEMALE, 1 MALE; STACKED	.250	16	7.51

*MLP per Standard Pack

Disconnects

DISCONNECT - FEMALE INSULATED



SOURCE 1 PART NO.	DESCRIPTION	STD PACK	MLP \$
S1-DA22	ASSORTED FEMALE DISCONNECTS	18	5.15
S1-D222	FEMALE DISCONNECT - 16-14W 0.250 (1/4")	16	5.15
S1-D222C	FEMALE DISCONNECT - 16-14W 0.250 (1/4")	100	26.19
S1-D232C	FEMALE DISCONNECT - 12-10 0.250 (1/4")	100	33.11

*MLP per Standard Pack

DISCONNECT - FEMALE FULLY INSULATED



SOURCE 1 PART NO.	DESCRIPTION	STD PACK	MLP \$
S1-DXF1C	FULL INSULATED FEMALE DISCONNECT - 22.18 W 250	100	55.19
S1-DXF2	FULL INSULATED FEMALE DISCONNECT - 16-14 W 250	10	5.11

*MLP per Standard Pack

Disconnect Terminals

DISCONNECT - SPECIAL PURPOSE



SOURCE 1 PART NO.	DESCRIPTION	STD PACK	MLP \$
S1-DS23	F/M PIGGYBACK - .250 (VOLKSWAGON)	20	5.11

*MLP per Standard Pack

Wire Connectors

CONNECTOR - FULLY INSULATED DEAD END



SOURCE 1 PART NO.	DESCRIPTION	WIRE RANGE	STD PACK	MLP \$
S1-6222LX	FULLY INSULATED DEAD END CONNECTORS	22-14	50	12.99
S1-6223LX	FULLY INSULATED DEAD END CONNECTORS	18-10	50	15.20

*MLP per Standard Pack

CONNECTOR - BX SET SCREW



BX cable range = .445 to .630 diameter. U.L. Listed. CSA Approved.

SOURCE 1 PART NO.	DESCRIPTION	STD PACK	MLP \$
S1-640-845	TRADE SIZE - 3/8"	100	1.07

*Sold by Standard Package/MLP Per Each

Circuit Breakers

CIRCUIT BREAKERS - SQUARE D

Circuit Breakers Double Pole, Homeline®, 120/240 VAC



QO Style Breakers with VISI-TRIP® (Visual Red Indicator in Window). UL & CSA Listed.

SOURCE 1 PART NO.	DESCRIPTION	STD PACK	MLP \$
S1-HOM220	20 AMP	5	29.84
S1-HOM230	30 AMP	5	29.84
S1-HOM235	35 AMP	5	29.84
S1-HOM240	40 AMP	5	29.84
S1-HOM245	45 AMP	5	29.84
S1-HOM250	50 AMP	5	29.84
S1-HOM260	60 AMP	5	29.84

*Sold by Standard Package/MLP Per Each

Circuit Breakers Single Pole, Homeline®, 120/240 VAC



SOURCE 1 PART NO.	DESCRIPTION	STD PACK	MLP \$
S1-HOM120	20 AMP	10	13.10

Breakers Double Pole, QO Style, 120/240 VAC



SOURCE 1 PART NO.	DESCRIPTION	STD PACK	MLP \$
S1-QO225	25 AMP	5	32.12
S1-QO235	35 AMP	5	32.12
S1-QO245	45 AMP	5	32.12

*Sold by Standard Package/MLP Per Each

Fuses

FUSES - BUSS

Dual Element Time Delay 250 Volt, Class RK5



SOURCE 1 PART NO.	AMP	STD PACK	MLP \$
S1-FRNR10	10	10	5.41
S1-FRNR100	100	5	17.22
S1-FRNR15	15	10	5.04
S1-FRNR20	20	10	4.08
S1-FRNR25	25	10	4.19
S1-FRNR30	30	10	4.08
S1-FRNR35	35	10	7.51
S1-FRNR40	40	10	7.65
S1-FRNR45	45	10	7.65
S1-FRNR50	50	10	7.65
S1-FRNR60	60	10	7.51
S1-FRNR70	70	5	17.51

*Sold by Standard Pack/MLP per each

Dual Element Time Delay 600 Volt, Class RK5



SOURCE 1 PART NO.	AMP	STD PACK	MLP \$
S1-FRSR10	10	10	10.52
S1-FRSR100	100	5	33.36
S1-FRSR12	12	10	10.52
S1-FRSR15	15	10	9.06
S1-FRSR25	25	10	9.31
S1-FRSR30	30	10	9.06
S1-FRSR35	35	10	15.97
S1-FRSR40	40	10	15.92
S1-FRSR45	45	10	15.97
S1-FRSR50	50	10	15.71
S1-FRSR60	60	10	15.71
S1-FRSR70	70	5	33.36

*Sold by Standard Pack/MLP per each

Fuse - Supplemental



SOURCE 1 PART NO.	DESCRIPTION	VOLT	AMPS	STD PACK	MLP \$
S1-GMQ-3-2/10	FUSE, TIME DELAY, REJECTION, 300V, 3.2A	300	3.2	5	18.69

FUSES - BLADE (AUTO)



SOURCE 1 PART NO.	DESCRIPTION	STD PACK	MLP \$
S1-626-AT0003	BLADE FUSE - 3 AMP - PURPLE	100	1.40
S1-626-AT0005	BLADE FUSE - 5 AMP - TAN	100	1.40

*Sold by Standard Pack/MLP per each

Fuses

FUSES - CARTRIDGE



SOURCE 1 PART NO.	DESCRIPTION	VOLT	AMPS	STD PACK	MLP \$
S1-FNQR1	CARTRIDGE FUSE; CLASS CC; TIME DELAY	600	1	10	16.34
S1-FNQR3	CARTRIDGE FUSE; CLASS CC; TIME DELAY	600	3	10	16.48
S1-FNQR5	CARTRIDGE FUSE; CLASS CC; TIME DELAY	600	5	10	16.63
S1-KTKR1	CARTRIDGE FUSE; FAST ACTING; CC REJECTION	600	1	10	13.32
S1-KTKR10	CARTRIDGE FUSE; FAST ACTING; CC REJECTION	600	10	10	13.32
S1-KTKR15	CARTRIDGE FUSE; FAST ACTING; CC REJECTION	600	15	10	13.32
S1-KTKR20	CARTRIDGE FUSE; FAST ACTING; CC REJECTION	600	20	10	13.32
S1-KTKR3	CARTRIDGE FUSE; FAST ACTING; CC REJECTION	600	3	10	13.32
S1-KTKR5	CARTRIDGE FUSE; FAST ACTING; CC REJECTION	600	5	10	16.60

*MLP per each/ Sold per standard package of 10

FUSES - NON-RENEWABLE CARTRIDGE



SOURCE 1 PART NO.	AMP	STD PACK	MLP \$
S1-NON30	30	10	6.96
S1-NON40	40	10	10.86
S1-NON50	50	10	10.77
S1-NON60	60	10	10.77

*Sold by Standard Pack/MLP per each

FUSE - ADAPTERS



SOURCE 1 PART NO.	DESCRIPTION	MLP \$
S1-626-38632	FUSE ADAPTER - 60 TO 30 REDUCER FOR CLASS H, 250V	16.85

FUSES - CLASS G TIME DELAY

Time Delay, 480V, UL Listed, CSA Certified



SOURCE 1 PART NO.	AMPS	MLP \$
S1-SC10	10	8.13
S1-SC15	15	5.37
S1-SC20	20	5.67
S1-SC30	30	10.52

Test Instruments

TEMPERATURE AND PRESSURE SENSORS

Sporlan Smart Service Tool Kit Wireless Temperature and Pressure Sensors



Features:

The Sporlan SMART Service Tool Kit was developed to make HVAC/R diagnostic readings faster, easier, and more accurate. The app automatically calculates and displays superheat and sub-cooling eliminating manual calculations. All of this data can be easily recorded, saved and emailed from the app, allowing technicians to diagnose issues faster, look at trends over time, and provide proof of work.

The Kit includes:

- Low Pressure Sensor (1)
- High Pressure Sensor (1)
- Temperature Sensors (2)
- Batteries (1 in each sensor and 4 spare)
- 1/8" MPT X 1/4" SAE adapters (2)
- Instructions

SOURCE 1 PART NO.	DESCRIPTION	MLP \$
S1-SV-953595	KIT,DIAGNOSTIC,SMART SERVICE TOOL	2003.23

DIAGNOSTIC DEVICES

GE TecMate Pro™

ECM Motor Module Diagnostic Tool



SOURCE 1 PART NO.	DESCRIPTION	MLP \$
S1-02642203000	MOTOR TESTER, GE TECAMATE PRO	401.43

AMP EXTRACTION TOOLS

Model - S1-52118452000



Features:

- Designed to remove Amp COMMERCIAL Mate-N-Lok contacts from their housings
- For pin or socket
- Instruction sheet included
- For use with 25, 30, 48 ton DSC, DSV units and 50 thru 100 ton YIC & YIV units

SOURCE 1 PART NO.	AMP CATALOG NO.	MLP \$
S1-52118452000	465644-1	66.37

Model - S1-52118453000



Features:

- Designed to remove Amp UNIVERSAL Mate-N-Lok pin & socket contacts from the connectors
- Approx. 4.50" long x 3/4 diameter
- Clips on pocket for easy carrying
- Instruction sheet included
- For use with commercial products 3 ton thru 25 ton

SOURCE 1 PART NO.	AMP CATALOG NO.	MLP \$
S1-52118453000	458994-2	144.55

Model - S1-52118454000



Features:

- Designed to remove Amp Mini-Universal Mate-N-Lok contacts from housing cavities
- Push rod inserts into the contact housing for easy removal of contact
- Instruction sheet included
- For use on Triathlon products

SOURCE 1 PART NO.	AMP CATALOG NO.	MLP \$
S1-52118454000	189727-1	82.31

Model - S1-52118456000



Features:

- Designed to remove Amp bifurcated leaf contacts from their housings
- Extraction tip inserts into housing for easy removal of contact
- Instruction sheet included
- For use with commercial products 3 ton thru 25 ton

SOURCE 1 PART NO.	AMP CATALOG NO.	MLP \$
S1-52118456000	90471-1	66.79

TEST ALL ACID TEST KIT



SOURCE 1 PART NO.	DESCRIPTION	MLP \$
S1-780042	KIT, TEST, ACID, TA-1	30.05

Cross Reference

REPLACEMENT COMPRESSORS

Danfoss Compressors SM Series Replacement for Trane COM Series

SOURCE 1 PART #	DANFOSS PART #	REPLACES TRANE	CAP BTUH	V-PH-Z	WEIGHT (LBS)	CONNECTION HEIGHT	NOMINAL TONNAGE	MLP \$
S1-SM115-3QAI	SM115-3QAI	COM06425	115,215	230/3/60	172	1-3/8 x 7/8	9.3	5346.14
S1-SM115-4QAI	SM115-4QAI	COM06426	115,215	460/3/60	172	1-3/8 x 7/8	9.3	4005.68
S1-SM125-3QAI	SM125-3QAI	COM06429	126,423	230/3/60	172	1-3/8 x 7/8	10	4199.07
S1-SM125-4QAI	SM125-4QAI	COM06430	126,423	460/3/60	172	1-3/8 x 7/8	10	4659.75
S1-SM175-3QAI	SM175-3QAI	COM06433	174,355	230/3/60	220	1-5/8 x 1-1/8	14	5110.64
S1-SM175-4QAI	SM175-4QAI	COM06434	174,355	460/3/60	220	1-5/8 x 1-1/8	14	4832.71
S1-SM185-3QAI	SM185-3QAI	COM06437	185,474	230/3/60	220	1-5/8 x 1-1/8	15	6442.79
S1-SM185-4QAI	SM185-4QAI	COM06438	185,474	460/3/60	220	1-5/8 x 1-1/8	15	6442.79

LG Scroll Compressors "Like for Like" Replacement for Copeland ZR Series

SOURCE 1 PART #	LG PART #	REPLACES COPELAND	CAP BTUH	V-PH-Z	RLA	LRA	EER	SUCT ID (IN.)	DISC ID (IN.)	SUCT HT (IN.)	DISC HT (IN.)	OVA HT (IN.)	MLP \$
S1-SQA022KAZ	SQA022KAZ	ZR21K5-PFV ZR21K5E-PFV	21500	230/208-1-60	10.4	53.5	11.0	3/4	1/2	11.12	15.41	16.90	887.43
S1-SQA026KAZ	SQA026KAZ	ZR25K5-PFV ZR25K5E-PFV	26100	230/208-1-60	11.5	60.0	11.0	3/4	1/2	11.12	15.41	16.90	924.86
S1-SQA032KAZ	SQA032KAZ	ZR32K5-PFV ZR32K5E-PFV	32300	230/208-1-60	14.4	72.0	11.1	3/4	1/2	11.12	15.41	16.90	962.82
S1-SQA038KAZ	SQA038KAZ	ZR38K5-PFV ZR38K5E-PFV	37000	230/208-1-60	16.5	81.1	11.1	3/4	1/2	11.12	15.41	16.90	1016.89
S1-SQA042KAZ	SQA042KAZ	ZR42K5-PFV ZR42K5E-PFV	41200	230/208-1-60	17.2	95.6	11.1	3/4	1/2	11.12	15.41	16.90	1075.04
S1-SR047KBZ	SR047KBZ	ZR48K5-PFV ZR48K5E-PFV	47600	230/208-1-60	20.1	109.0	11.0	7/8	1/2	12.79	17.24	18.94	1198.93
S1-SRA053KAZ	SRA053KAZ	ZR54K5-PFV ZR54K5E-PFV	53500	230/208-1-60	23.1	157.0	11.3	7/8	1/2	12.79	17.24	18.94	1268.82
S1-SR057KCZ	SR057KCZ	ZR57K3-PFV	58000	230/208-1-60	26.3	159.0	10.8	7/8	1/2	12.79	17.24	18.94	1302.75

	LG	COPELAND		LG	COPELAND	
PART NUMBER	SQA022KAZ	ZR21K5-PFV	ZR21K5E-PFV	SQA026KAZ	ZR25K5-PFV	ZR25K5E-PFV
CAPACITY BTUH	21500	21000	20200	26100	25300	24300
V-PH-Z	230/208-1-60	230/208-1-60	230/208-1-60	230/208-1-60	230/208-1-60	230/208-1-60
RLA	10.4	12.0	12.0	11.5	15.0	15.0
LRA	53.5	56.0	56.0	60.0	68.0	68.0
EER	11.0	10.6	9.9	11.0	10.9	10.3
SUCT ID (IN.)	3/4	3/4	3/4	3/4	3/4	3/4
DISC ID (IN.)	1/2	1/2	1/2	1/2	1/2	1/2
SUCT HT (IN.)	11.12	10.20	10.20	11.12	10.20	10.20
DISC HT (IN.)	15.41	14.35	14.35	15.41	14.35	14.35
OVERALL HT (IN.)	16.90	15.86	15.86	16.90	15.86	15.86

	LG	COPELAND		LG	COPELAND	
PART NUMBER	SQA032KAZ	ZR32K5-PFV	ZR32K5E-PFV	SQA038KAZ	ZR38K5-PFV	ZR38K5E-PFV
CAPACITY BTUH	32300	32600	31300	37000	38000	36600
V-PH-Z	230/208-1-60	230/208-1-60	230/208-1-60	230/208-1-60	230/208-1-60	230/208-1-60
RLA	14.4	17.1	17.1	16.5	21.4	21.4
LRA	72.0	87.0	87.0	81.1	112.0	112.0
EER	11.1	11.2	10.5	11.1	11.2	10.5
SUCT ID (IN.)	3/4	3/4	3/4	3/4	7/8	7/8
DISC ID (IN.)	1/2	1/2	1/2	1/2	1/2	1/2
SUCT HT (IN.)	11.12	10.20	10.20	11.12	11.27	11.27
DISC HT (IN.)	15.41	14.35	14.35	15.41	15.53	15.53
OVERALL HT (IN.)	16.90	15.86	15.86	16.90	16.94	16.94

	LG	COPELAND		LG	COPELAND	
PART NUMBER	SQA042KAZ	ZR42K5-PFV	ZR42K5E-PFV	SR047KBZ	ZR48K5-PFV	ZR48K5E-PFV
CAPACITY BTUH	41200	42200	40800	47600	48200	46200
V-PH-Z	230/208-1-60	230/208-1-60	230/208-1-60	230/208-1-60	230/208-1-60	230/208-1-60
RLA	17.2	22.1	22.1	20.1	24.3	24.3
LRA	95.6	104.0	104.0	109.0	137.0	137.0
EER	11.1	11.3	10.8	11.0	11.4	10.9
SUCT ID (IN.)	3/4	7/8	7/8	7/8	7/8	7/8
DISC ID (IN.)	1/2	1/2	1/2	1/2	1/2	1/2
SUCT HT (IN.)	11.12	11.27	11.27	12.79	11.27	11.27
DISC HT (IN.)	15.41	15.53	15.53	17.24	15.53	15.53
OVERALL HT (IN.)	16.90	19.94	19.94	18.94	16.94	16.94

Cross Reference

REPLACEMENT COMPRESSORS

LG Scroll Compressors “Like for Like” Replacement for Copeland ZR Series

	LG	COPELAND		LG	COPELAND	
PART NUMBER	SRA053KAZ	ZR54K5-PFV	ZR54K5E-PFV	SR057KCZ	ZR57K3-PFV	ZR57K3E-PFV
CAPACITY BTUH	53500	53500	50100	58000	58000	55500
V-PH-Z	230/208-1-60	230/208-1-60	230/208-1-60	230/208-1-60	230/208-1-60	230/208-1-60
RLA	23.1	28.2	28.2	26.3	32.1	32.1
LRA	157.0	146.0	146.0	159.0	148.0	148.0
EER	11.3	11.3	10.3	10.8	11.5	10.6
SUCT ID (IN.)	7/8	7/8	7/8	7/8	7/8	7/8
DISC ID (IN.)	1/2	1/2	1/2	1/2	1/2	1/2
SUCT HT (IN.)	12.79	11.27	11.27	12.79	11.86	11.86
DISC HT (IN.)	17.24	15.53	15.53	17.24	16.13	16.13
OVERALL HT (IN.)	18.94	16.94	16.94	18.94	17.75	17.75

ICM HVACR CONTROLS

Condensation Control/Alarm

REPLACEMENT MODEL	SOURCE 1 PART #
WATER GUARD: 401475	S1-ICM340

Delay on Make Timers

REPLACEMENT MODEL	SOURCE 1 PART #
A-1: 7061	S1-ICM103
A-1: EAC-701-ADJ	S1-ICM102
A-1: EAC-710-180, EAC-701010-W, EAC-700-A	S1-ICM100
A-1: EAC-710-300, EAC-701-300-W	S1-ICM101
DIVERSIFIED: ASC-200	S1-ICM150
DIVERSIFIED: AC-800	S1-ICM102, S1-ICM105
DIVERSIFIED: ASC-600, ASC-601	S1-ICM105
DIVERSIFIED: ASC-600-3, ASC-601-3	S1-ICM100
GEMLINE: 1C213	S1-ICM102, S1-ICM103, S1-ICM105
GEMLINE: 1C310	S1-ICM102, S1-ICM105
ICE-O-MATIC: TD3001A	S1-ICM103
MARS: 32019, 32391, 32367	S1-ICM102
MARS: 32394, 32396	S1-ICM103
MARS: 32091	S1-ICM105
MARS: 32395	S1-ICM175
ROBERTSHAW: 3310-068	S1-ICM103
SUPCO: TD32	S1-ICM175
SUPCO: TD68	S1-ICM105
SUPCO: TD69	S1-ICM102
SUPCO:TD693 (18-30V)	S1-ICM100
SUPCO: TD693W (18-30V)	S1-ICM100F
SUPCO: TD695 (18-30V)	S1-ICM101
SUPCO: TD695W (18-30V)	S1-ICM101F
SUPCO: TD69W	S1-ICM102F
SUPCO: TMF-19, TMF-80	S1-ICM103
WAGNER/DIVERSITECH: ADM-1	S1-ICM102
WAGNER/DIVERSITECH: ADM-2	S1-ICM102F

Delay on Break Timers

REPLACEMENT MODEL	SOURCE 1 PART #
A-1: EAC-426-180	S1-ICM204, S1-ICM207
A-1: EAC-426-300	S1-ICM205, S1-ICM208
A-1: EAC-426-ADJ	S1-ICM206, S1-ICM209
A-1: EAC-500	S1-ICM200F, S1-ICM201, S1-ICM201F
A-1: EAC-501-300-W	S1-ICM201, S1-ICM201F
A-1: EAC-501-180-W	S1-ICM200
A-1: EAC-501-ADJ	S1-ICM203
A-1: EAC650	S1-ICM210, S1-ICM212
DIVERSIFIED: AC-100-3	S1-ICM200, S1-ICM204, S1-ICM207
DIVERSIFIED: AC-100-5	S1-ICM205, S1-ICM208
DIVERSIFIED: AC-503	S1-ICM203
DIVERSIFIED: AC-505-5	S1-ICM201F
DIVERSIFIED: ASC-500-5	S1-ICM201
MARS: 32390	S1-ICM201
MARS: 32005, 32505	S1-ICM201F
MARS: 32001, 32387, 32392	S1-ICM203
MARS: 32381	S1-ICM204, S1-ICM207
MARS: 32382	S1-ICM205, S1-ICM208
MARS: 32565	S1-ICM209
ROBERTSHAW: 3310-072	S1-ICM203
ROBERTSHAW: 3310-183	S1-ICM204, S1-ICM207
ROBERTSHAW: 3310-305	S1-ICM205, S1-ICM208
SUPCO: TD72, TD73	S1-ICM203
SUPCO: TD733 (18-30V)	S1-ICM200
SUPCO: TD733W (18-30V)	S1-ICM200F
SUPCO: TD735 (18-30V)	S1-ICM201
SUPCO: TD735W (18-30V)	S1-ICM201F
SUPCO: TD73W	S1-ICM203F
SUPCO: TD74	S1-ICM206
SUPCO: TD74H	S1-ICM209
SUPCO: TL243	S1-ICM204, S1-ICM207
SUPCO: TL245	S1-ICM205, S1-ICM208
WAGNER/DIVERSITECH: ADB-1	S1-ICM203
WAGNER/DIVERSITECH: ADB-2	S1-ICM203F

Cross Reference

ICM HVACR CONTROLS

Delay on Break Timers

REPLACEMENT MODEL	SOURCE 1 PART #
AMANA: C64301-1, C64310-1	S1-ICM300
ARCOAIRE: 32312-00, 3232140	S1-ICM300
ARTESIAN: 10321-00	S1-ICM300
AVION: DFT100	S1-ICM315
CARRIER: CES0110063-00, -01, -02, -02A	S1-ICM321
CARRIER: CES0130024-00	S1-ICM322
CARRIER: HK25S2359/9A	S1-ICM320
CARRIER: HK32FA006	S1-ICM320
ESSEX: 621-1 TO 621-10, 621-110, 621-111, 621-310-110	S1-ICM300
FAST: 1093410	S1-ICM307
GOETTL: 305007	S1-ICM301
GOODMAN: B12260-06	S1-ICM300
GOODMAN: B1226008	S1-ICM318
HEIL QUAKER: HQ1052757	S1-ICM300
HONEYWELL: ST74A1004/20/38	S1-ICM300
ICM: DFORB24A2I300	S1-ICM319
ICM: DFORB-AB1004	S1-ICM302
ICM: DFORF	S1-ICM303C
ICM: DFOSP24A2	S1-ICM301
ICM: W1001-4	S1-ICM318
ICP: 1052757	S1-ICM300
ICP: 1069364	S1-ICM304

Duty Cycle Controls

REPLACEMENT MODEL	SOURCE 1 PART #
CARRIER: HH84AA017, HH84AA018	S1-ICM278
CARRIER: HN67ZA012A	S1-ICM305
SSAC: ESDR, TSDR SERIES	S1-ICM305
SSAC: ESDR, TSDR SERIES	S1-ICM305

Fan Blower Controls

REPLACEMENT MODEL	SOURCE 1 PART #
A-1: 5893	S1-ICM255
BARD: 8201-056	S1-ICM255
CARRIER: 302075-3, CES0110017, CES0110018	S1-ICM271
CARRIER: CES0110019	S1-ICM275
CARRIER: HH84AA001/003/005/009/014/015/021	S1-ICM275
CARRIER: HH84AA010/011/012/013/020, P771-7002	S1-ICM271
CARRIER: HK61GA001/03	S1-ICM272
EMI: 240000-969	S1-ICM273
EMI: 240-1764	S1-ICM274
EVCON: 2702-300	S1-ICM270
FIELD CONTROLS: 46144700	S1-ICM253
GEMLINE: 1C216	S1-ICM253
GOODMAN: B1370735S, PCBFM131S	S1-ICM277
HONEYWELL: S876AA1016	S1-ICM254
MARS: 32377, 32378, 32379	S1-ICM251
MARS: 32393	S1-ICM253
MARS: 32574	S1-ICM255
RHEEM: 42-22515-01/02/03	S1-ICM255
RHEEM: 47-22827-01	S1-ICM270
RHEEM: 47-22827-81/82/83	S1-ICM270
RHEEM: 47-22828-01/02	S1-ICM270
ROBERTSHAW: 695-003	S1-ICM270
ROBERTSHAW: 695-100	S1-ICM271
ROBERTSHAW: 695-101	S1-ICM275
SNYDER GENERAL/ICP: 1395336	S1-ICM255
TEXAS INSTRUMENTS: 2FD-1	S1-ICM272
WATSCO: PSTD-000-005W, PSTD-000-060W	S1-ICM254

Fan Coil Relay Control Boards

REPLACEMENT MODEL	SOURCE 1 PART #
BSR/XACTONE: FC/H-1	S1-ICM6201
BSR/XACTONE: FC/H-2	S1-ICM6201
HONEYWELL: W6380B	S1-ICM6200

REPLACEMENT MODEL	SOURCE 1 PART #
ICP: HEAT ACTIVE (B) RV	S1-ICM323
INTERTHERM: 6208800	S1-ICM300
LENNOX: 33G9501	S1-ICM300
LENNOX: 86G16	S1-ICM307
MARS: 32572	S1-ICM300
NORDYNE: 621301A	S1-ICM302
NORDYNE: 621579B, 621579C	S1-ICM302
NORDYNE: 917178	S1-ICM302
NORDYNE: 624519A	S1-ICM319
RANCO: DT2	S1-ICM307
RHEEM: 47-21776-01	S1-ICM300
RHEEM: 47-21776-06	S1-ICM301
ROBERTSHAW/UNI-LINE: TD-10, DT2-1000	S1-ICM300
SNYDER GENERAL: 1395-329	S1-ICM300
STEVECO: 90-621	S1-ICM300
THERM-O-DISC: 26E-10	S1-ICM300
TRANE: 21C142827G01	S1-ICM316
TRANE: CNT1152, CNT1642	S1-ICM316
WEATHERKING (ADDISON): 840-4-5548	S1-ICM300
WHITE-RODGERS: 90-621	S1-ICM300

Head Pressure Controls

REPLACEMENT MODEL	SOURCE 1 PART #
ACT: FM2000	S1-ICM325HN
ACT: FM4000	S1-ICM327HN
ACT: FM4000	S1-ICM326HN
HOFFMAN: 800, 800AA, 814-50, 816-10	S1-ICM325HN, 326HN, 327HN
MITSUBISHI: MU09NW, MUH09NW, MU12NN, MU15NN, MU17NN, MUM18NW, MUM30NN, MUM30NN2	S1-ICM326HM2
RANCO: E31	S1-ICM325HN, S1-ICM326HN, S1-ICM327HN

Impedance/Lockout Relay

REPLACEMENT MODEL	SOURCE 1 PART #
ESSEX: RELAY SERIES 84.93	S1-ICM220

Line Monitors

REPLACEMENT MODEL	SOURCE 1 PART #
A-1: EAC-401, 402, 403, 404	S1-ICM491, S1-ICM492, S1-ICM493
A-1: EAC-800, EAC-8000, EAC-8002	S1-ICM400, S1-ICM450, S1-ICM450S
BRISTOL: 241680	S1-ICM441
COPELAND: 071-0376-01 & -02, 071-0397-00 & -01, 071-0424-00 & -01, 071-9800-01 & -02	S1-ICM441
COPELAND: 085-0160-00	S1-ICM450, S1-ICM450S
DIVERSIFIED: AC-2020, AC-301, AC-302	S1-ICM400, S1-ICM450, S1-ICM450S
DIVERSIFIED: CV-100-RS, CV-200-RS15, CV-200-RS20	S1-ICM491
MARS: 32512, 32515, 32516, 32517	S1-ICM400
MARS: 32536	S1-ICM401, S1-ICM402
MARS: 32532, 32534, 32540, 32541, 32542	S1-ICM408
MARS: 37300, 37302, 37304, 37306, 37322	S1-ICM441
MARS: PFM-2000	S1-ICM450
MOTORSAVER: 455	S1-ICM400, S1-ICM450, S1-ICM450S
SSAC: QLM, QLV	S1-ICM400, S1-ICM450, S1-ICM450S
SUPCO: TPMP2	S1-ICM401, S1-ICM402
TEXAS INSTRUMENTS: 15AA1600B, 15AA1600C, 15AA1603B, 15AA1603C, 31AA1600E, 31AA1606E	S1-ICM441
TIMEMARK: 265	S1-ICM400, S1-ICM450, S1-ICM450S
WAGNER/DIVERSITECH: DSP-1	S1-ICM491, S1-ICM492, S1-ICM493
WAGNER/DIVERSITECH: DTP-3, WPC-800	S1-ICM400, S1-ICM450, S1-ICM450S

Fan Safety Alarm

REPLACEMENT MODEL	SOURCE 1 PART #
FUNCTIONAL DEVICES: RIBMNLB-6	S1-ICM6100

Cross Reference

ICM HVACR CONTROLS

Universal Motor Starting Relays

REPLACEMENT MODEL	SOURCE 1 PART #
SUPCO: SUPR. APR5	S1-UMSR-50

Surge Protection

REPLACEMENT MODEL	SOURCE 1 PART #
INTERMATIC: AG3000	S1-ICM517
SUPCO: SCMPLUS. SCM150	S1-ICM516, ICM517

Furnace Control Boards

REPLACEMENT MODEL	SOURCE 1 PART #
AMANA/GOODMAN: 10207701, 102077-02, 102077-03, 10207704, 102077-04, 10207706, 102077-09, 10207710, 10207710, 10207714, 10207717, 10207718, 10207719, 10207720, 10207720S	S1-50M56U-843
CARRIER: 325878-751	S1-ICM282
CARRIER: CES0110057-00/01/02	S1-ICM281
CARRIER: CES0110020, CES0110048	S1-ICM281
CARRIER: CES0110074-01	S1-ICM2804
CARRIER: HH84AA016	S1-ICM281
CARRIER: LH33WP003/3A	S1-ICM291
CARRIER: 325878-781, HK42F2004, HK42F007, HK42F008, HK42F009, HK42F011, HK42F013, HK42F016, HK42F034	S1-50M56U-751
GOODMAN: PCBFF112S, B1809926S	S1-ICM286
GOODMAN: B18099-04	S1-ICM287
GOODMAN: B18099-06/08/10/13/13S	S1-ICM280, S1-50T35-743
LENNOX: ALL BCC1, BCC2, BCC3 CIRCUIT BOARDS, INCLUDING 48K98	S1-ICM289
LENNOX: 100925-02, 100925-03, 10M93, 10M9301, 12L6901, 12L4201, 32M8801	S1-50M56U-843
RHEEM: 62-24140-04	S1-ICM292
RHEEM: 62-24084-82	S1-ICM288
TEXAS INSTRUMENTS: 41F-5	S1-ICM280, S1-50T35-743
TRANE: CNT03076, CNT03098, CNT03798, CNT05164, CNT05165	S1-50A65-5165
TRANE: CNT04664	S1-50T35-743
UTEC: 1012-933D	S1-ICM280, S1-50T35-743
UTEC: 1012-83-9336AHSC1, 1012-83-9337A, 1012-925A, 1012-925B, 1012-925C, 1012933D, 1012-933D	S1-50M56U-843
WHITE-RODGERS: 50T35-730, 50T35-743	S1-ICM280

Gas Ignition Controls

REPLACEMENT MODEL	SOURCE 1 PART #
LENNOX: 12L4201, 56L8501, 56L84, 56L8401	S1-50A55-843
ROBERTSHAW: H5780	S1-ICM283
ROBERTSHAW: DS845 780-504	S1-50D50-842
ROBERTSHAW: 780-001 (002, 003, 845, 715, 735, 736, 737), SP715, SP715A, SP735, SP735D, SP735L, USI715U	S1-50D50-843
ROBERTSHAW: 780-780 (783, 784, 785, 786, 788, 789, 790, 910)	S1-50E47-843
ROBERTSHAW: 780-701, 710-713, 715, 735-737, SP710, SP715, SP720, SP730, SP735, SP750 SERIES	S1-S8610U3009
ROBERTSHAW: HS780-17NL- (104A, 106A, 108A, 304A, 306A, 308A), HS780-17NR- (104A, 106A, 108A, 304A, 306A, 308A, 312A), HS780-17PL- (106A, 108A, 304A, 306A, 308A), HS780-17PR- (104A, 108A, 306A), HS780-34NL- (106A, 108A, 304A, 306A, 308A, 312A), HS780-34NR- (104A, 106A, 304A, 306A, 308A, 312A), HS780-34PL- (104A, 106A, 108A, 304A, 306A, 308A), HS780-34PR- (106A, 108A, 304A, 306A, 308A)	S1-50E47-843

Gas Ignition Controls (cont.)

REPLACEMENT MODEL	SOURCE 1 PART #
ROBERTSHAW: HS780-17NL-104A, HS780-17NL-108A, HS780-17NL-304A, HS780-17NL-308A, HS780-17NR-104A, HS780-17NR-306A, HS780-34NL-108A, HS780-34NL-304A, HS780-34NL-306A, HS780-34NL-308A, HS780-34NR-104A, HS780-34NR-306A, HS780-34NR-308A, HS780-34NR-312A, HS780-34PL-308A	S1-S8910U3000
THERMO PRODUCTS: 350760	S1-50E47-843
TRANE: CNT03076, CNT03742, CNT03798, CNT05164, CNT05165	S1-50A65-843
TRANE: CNT02789, CNT02891, CNT03799	S1-50A55-3797
TRANE: CNT02789, CNT02891, CNT03799, CNT1684, CNT1686, CNT1687	S1-50A55-843
TRANE: CNT1316, CNT1690, CNT1691	S1-50E47-843
UNITED TECHNOLOGIES: 120-08027	S1-50E47-843
WHITE RODGERS: 50E47, 50F47	S1-ICM283
AMANA/GOODMAN: 102077-02, 102077-03, 10207704, 102077-04, 10207706, 102077-09, 10207710, 10207714, 102077-14, 10207714, PCBFF117	S1-50A55-843
AMANA/GOODMAN: 10207717, 102077-17, PCBFF118S	S1-50A65-843
AMANA/GOODMAN: C6411102	S1-50E47-843
CARRIER: LH33WZ510	S1-ICM295
CARRIER: LH33WZ512A	S1-ICM296
CARRIER: 1001346	S1-50E47-843
FENWAL: 05-203025-005, 05-203026-005	S1-50D50-843
FENWAL: 832-002, 832-005	S1-50E47-843
HONEYWELL: S8610U (AND COMPATIBLE CAMSTAT, FENWAL, HSC, PENN-JOHNSON, ROBERTSHAW AND WHITE RODGERS MODELS)	S1-ICM290A
HONEYWELL: S8680, S87B1008, S87B1016, S87C1006, S87C1014, S87D1004, S87D1012, S87J1026	S1-50D50-842
HONEYWELL: S86A - (1001, 1019, 1027, 1035), S86B - (1009, 1017, 1025), S86C - (1007, 1015, 1031, 1049, 1056), S86D - (1005, 1021), S86E - (1002, 1010, 1028, 1036, 1044, 1051, 1069, 1077, 1101, 1119, 1127), S86F - (1000, 1018, 1026, 1042, 1059, 1067, 1075, 1083, 1091), S86G - (1008, 1016, 1032, 1057, 1073), S86H - (1006, 1022, 1048, 1089, 1097, 1105, 1121, 1147), S90A1005, S90B1003, S90B1011, S8600A1001, S8600B1009, S8600C1015, S8600F1000, S8600F1034, S8600F1042, S8600H1006, S8600H1022, S8600H1048, S8600H1055, S8600H1089, S8600H1105, S8600M1005, S8600M1013, S8610A1009, S8610B1007, S8610B1015, S8610C1005, S8610F1008, S8610F1016, S8610F1024, S8610F1032, S8610H1012, S8610H1038, S8610H1046, S8610H1053, S8610I079, S8610M1003, S8610M1029, S8610U1003, S8610H1002, S8610H1028	S1-50D50-843
HONEYWELL: S890C1007, S890D1006, S890G1003, S890G1011, S890G1029, S890G1037, S890H1002, S890H1010, S890H1028, S8910U, S8910U, S8910U1000, S89C1004, S89C1012, S89C1046, S89C1079, S89C1087, S89C1103, S89D1002, S89G1005, S89G1013, S89G1021, S89G1047, S89H1003, S89H1011, S89H1029, S89J1008	S1-50E47-843
ICP: 1380686, 1380698, 1380699	S1-50A55-843
ICP: 1380694	S1-50E47-843
LENNOX: 10M93, 10M931, 12L69, 12L6901, 32M88, 32M8801	S1-50A65-843
LENNOX: G776 (63K2401, 41K8701, 69J3601)	S1-ICM2902

Oil Burner Primary Control

REPLACEMENT MODEL	SOURCE 1 PART #
CARLIN: 48245	S1-ICM1503
HONEYWELL: R8184G: 4009, 1138, 1427, 4025	S1-ICM1503
HONEYWELL: R818AG: 4066, 1161, 1294	S1-ICM1501
HONEYWELL: R8184G: 4074, 1179, 1302, 4033	S1-ICM1502
WHITE-RODGERS: 668-401	S1-ICM1503

Cross Reference

ICM HVACR CONTROLS

Motor Starter/Rapid Start

REPLACEMENT MODEL	SOURCE 1 PART #
5-2-1: CSR-U1	S1-ICM803, S1-ICM866U
5-2-1: CSR-U2/U3	S1-ICM805, S1-ICM866U
A-1: WSX-5	S1-ICM855
A-1: WSX-6	S1-ICM856
KICKSTART: KS1	S1-ICM805, S1-ICM866U
KICKSTART: T05, KS8	S1-ICM803, S1-ICM866U
MARS: 32701, 35701	S1-ICM855
MARS: 32702, 35702	S1-ICM856
MARS: 32481	S1-ICM857
SUPCO: SPP-5	S1-ICM855
SUPCO: SPP-5E	S1-ICM850, S1-ICM866U
SUPCO: SPP-6	S1-ICM856
SUPCO: SPP-63	S1-ICM860, S1-ICM866U
SUPCO: SPP-8, SPP-8E	S1-ICM803, S1-ICM866U
SUPCO: RC0210	S1-ICM859
SUPCO: RC0410	S1-ICM858
SUPCO: RC0810	S1-ICM857
WAGNER/DIVERSITECH: DST-5	S1-ICM855
WAGNER/DIVERSITECH: DST-6	S1-ICM856

Equipment Paint Guide

PAINT	COLOR	LUSTER	USE
S1-51302934000	CHAMPAGNE	METALLIC W/FLAKE	YMA, YMB, CMA, CMB, YZE,
S1-51301503000	TITANIUM	METALLIC W/FLAKE	AC2, AC3, AL2, AL3
S1-51301505000	CHAMPAGNE	NON-METALLIC	GM8T, GM9T, GM8S, GM9S, GM8V, GM9V, GR8S, GY8S, GY9S, GG8S, GG9S, FC9S, FC9T, FC9V, FL9S, FL9T, FL9V, FL9C, FL9M, FC9C, FC9M, FC8T, FC8V, TM8M, TG8S, TG9S, TM8X, TM9X, TP8C, TPLC, TP9C , TG9S, TM8Y, TM9Y, DGAA, DGAAH, UGA, UGAE, DGAE, DGAF, DGAD, MG9S, UGAD, UGAE, UGAF, LY8S, L8D, LM8S, LF8, G8C, FG8, GF8, YM8M, LM8M, CM8M, YP8C, LP8C, CP8C, YPLC, CP8C, LPLC, TPLC, PS8, PV8, PT8, PS9, PV9, PT9, RGF, YM9M, LM9M, CM9M, TM9M, LP9C, LP9C, CP9C, TP9C, AVG, AHP, AVY, AVL, AVC, SVY, AVC, MA, MV, NVS, NAH, FRP, FRC, FFP, AHX, AVC, AHV, AHE, AHR, RFCX, GCGD, TGCD YCJD, TCHD, TCHD, YCGF, CCGD, GHGD, THGD, YHJD, GHRD, YHJF, THGF, YCJF, PAC, PHP, JP, SJ, NL, NM, UB, UQ, DNZ, DYZ, ACZ, DNQ, DYQ, DNY, DYY, DEQ, DPQ, BHX, BUX, BHQ, BUQ, DHQ, DUQ, BHZ, BUZ, HPZ, DNX, DYX, DEX, DPX
S1-51301532000	TITANIUM	NON-METALLIC	CCJD, LCJD, TCJD, TCGF, CCJF, LCJF, CHJD, LHJD, THJD, THRD, THJF, LHJF, CHJF
S1-51301530000	CHAMPAGNE 2	METALLIC WITHOUT FLAKE	YZE, YZH, CZE, CZF, YZF, CZH
S1-51301531000	TITANIUM 2	METALLIC WITHOUT FLAKE	AC5, AC6, AC8, HC5, HC5, HC6, AL5, AL6, AL8, HL5, HL6, HL8
S1-51301533000	GRANITE GREY	NON-METALLIC	OTC PRODUCTS - RAC*J, RHP*J, RHP*R, RGF, RAC*L, RAW*L, RHP*L, RAC14, RAC17, GAW, RFCX, RAC17. RAC13F
S1-51301535000	CHAMPAGNE	GLOSSY	POST PAINTED PRODUCTS Y AND Z CHASSIS STARTING IN 2014 - YZE, YZH, CZE, CZF, YZF, GCGD, TGCD YCJD, TCHD, TCHD, YCGF, CCGD, GHGD, THGD, YHJD, GHRD, YHJF, THGF, YCJF
S1-51301536000	TITANIUM	GLOSSY	POST PAINTED PRODUCTS Y AND Z CHASSIS STARTING IN 2014 - AC3, AC5, AC6, AC8, HC3, HC5, HC5, HC6, AL3, AL5, AL6, AL8, HL3, HL5, HL6, HL8, CCJD, LCJD, TCJD, TCGF, CCJF, LCJF, CHJD, LHJD, THJD, THRD, THJF, LHJF, CHJF
S1-51301537000	BLACK	GLOSSY	PANELS -AC3, AC5, AC6, AC8, HC3, HC5, HC5, HC6, CC7, CC16, CH16,
S1-51301535000	CHAMPAGNE	GLOSSY	YCE, YCS, YCD, YFE, YHE, YCG, YHM, CM, CF, CU, AP, AE, AVC, MP, ME, MVC, CM, CF, YCS, YFD, ALL FURNACE DOORS STARTING IN 2014
S1-51301536000	TITANIUM	GLOSSY	TC3, TC4, TW4, TF4, TH4, CC7, TC7, CC16, TC16, QW4, QH4, TH16, TF3,
S1-51301535000	CHAMPAGNE	GLOSSY	PCG4, PHE4, PCE4, PHG4, PCG6, PHE6, PCE6

General Information

ALTITUDE PRESSURE TABLE		
MERCURY AT 0°C (32°F.)		
ALTITUDE IN FEET	INCHES OF MERCURY	IN MILLIMETERS OF MERCURY
-1,000	31.02	787.9
0	29.921	760.0
1,000	28.86	732.9
2,000	27.82	706.6
3,000	26.81	681.1
4,000	25.84	656.3
5,000	24.8Y	632.3
6,000	23.98	609.0
7,000	23.09	586.4
8,000	22.22	564.4
9,000	21.38	543.2
10,000	20.58	522.6
15,000	16.88	428.8
20,000	13.75	349.1
25,000	11.10	281.9
30,000	8.88	225.6
35,000	7.04	178.7
40,000	5.54	140.7
45,000	4.36	110.8
50,000	3.436	87.30

SPECIFIC GRAVITIES OF GASES		
(BASED ON 68°F AND 14.7 LBS ABS)		
ALTITUDE IN FEET	INCHES OF MERCURY	IN MILLIMETERS OF MERCURY
ACETYLENE	C2H2	.897
AIR		1.000
AMMONIA	NH3	.587
ARGON	A	1.378
BUTANE-N	C4H40	2.390
BUTANE-ISO	(CH)3)2CH	656.3
CH3	1.990	632.3
CARBON DIOXIDE	CO2	1.517
CARBON MONOXIDE	CO	.966
CHLORINE	CL2	2.452
ETHANE	C2H6	1.035
HELIUM	HE	.138
HYDROGEN	H2	.070
METHANE	CH4	.553
NATURAL GAS		.665 (APPROX. AVG.)
NITRIC OXIDE	NO	1.035
NITROGEN	N2	.966
NITROUS OXIDE	N2O	1.518
OXYGEN	O2	1.103
PROPANE	C3H8	1.550
SULPHUR DIOXIDE	SO2	2.209

VOLUME EQUIVALENTS	
1 CU. FT. =	1728 CU. IN.
	7.481 GAL. (U.S.)
	28.317 LITERS
	28,317 CU. CM.
1 GAL (U.S.) =	231 CU. IN.
	.1337 CU. FT.
	3.785 LITERS
	3785 CU. CM.
1 LITER	.0353 CU. FT.
	.2642 GAL. (U.S.)
	1000 CU. CM.

AREA OF CIRCLES IN FT2			
DIAM. IN INCHES	AREA SQUARE FEET	DIAM. IN INCHES	AREA SQUARE FEET
1	.0054	30	4.909
1-1/2	.0123	31	5.241
2	.0218	32	5.585
2-1/2	.0341	33	5.940
3	.0491	34	6.305
3-1/2	.0668	35	6.611
4	.0873	36	7.069
4-1/2	.1105	37	7.467
5	.1364	38	7.876
5-1/2	.1650	39	8.296
6	.1964	40	8.727
6-1/2	.2305	41	9.168
7	.2673	42	9.621
7-1/2	.3068	43	10.08
8	.3491	44	10.56
8-1/2	.3940	45	11.04
9	.4418	46	11.54
9-1/2	.4923	47	12.05
10	.5454	48	12.57
11	.6600	49	13.10
12	.7854	50	13.64
13	.9218	51	14.19
14	1.069	52	14.75
15	1.227	53	15.32
16	1.396	54	15.90
17	1.576	56	17.10
18	1.767	58	18.35
19	1.969	60	19.63
20	2.182	62	20.97
21	2.405	64	22.34
22	2.640	66	23.76
23	2.885	68	25.22
24	3.142	70	26.73
25	3.409	72	28.27
26	3.687	74	29.87
27	3.976	76	31.50
28	4.276	78	33.18

FLOW EQUIVALENTS							
1 CU. FT./HR.		1 CU. FT./MIN.		1 CC/MIN.		1 CC/HR.	
.0166	CU. FT./MIN.	60	CU. FT./HR.	60	CC/HR.	.0167	CC/MIN.
.4719	LPM	28.316	LPM	.000035	CU. FT./MIN.	.0000005	CU. FT./MIN.
28.316	LPH	1699	LPH	.0021	CU. FT./HR.	.00003	CU. FT./HR.
471.947	CC/MIN.	28317	CC/MIN.	.001	LPM	.000017	LPM
28317	CC/HR.	1,699,011	CC/HR.	.06	LPH	.001	LPH
.1247	GAL/MIN.	7.481	GAL/MIN.	.00026	GAL/MIN.	.000004	GAL/MIN.
7.481	GAL/HR.	448.831	GAL/HR.	.0159	GAL/HR.	.00026	GAL/HR.
1 LPM		1 LPH		1 GAL/MIN.		1 GAL/HR.	
60.	LPH	.0166	LPM	60	GAL/HR.	.0167	GAL/MIN.
.035	CU. FT./MIN.	.00059	CU. FT./MIN.	.1337	CU. FT./MIN.	.002	CU. FT./MIN.
2.1189	CU. FT./HR.	.035	CU. FT./HR.	8.021	CU. FT./HR.	.1337	CU. FT./HR.
1000	CC/MIN.	16.667	CC/MIN.	3.785	LPM	.063	LPM
60,002	CC/HR.	1000	CC/HR.	227.118	LPH	3.785	LPH
.264	GAL/MIN.	.004	GAL/MIN.	3,785.412	CC/MIN.	63.069	CC/MIN.
15.851	GAL/HR.	.264	GAL/HR.	227,125	CC/HR.	3785	CC/HR.

Conversion Factors

MULTIPLY	BY	OBTAIN
Atmospheres	76.0	cms mercury
atm	29.92	ins mercury
atm	33.90	ft water
atm	1.0333	kgs/sq cm
atm	14.70	lbs/sq in
atm	1.058	tons/sq ft
Barrels-Oil	42	gals-oil
BT Units	0.2520	kgs-calories
BTU's	777.5	ft-lbs
BTU's	3.927 X 10-4	hp-hrs
BTU's	107.5	kg-meters
BTU's	2.928 X 10-4	kw-hrs
BTU Min	12.96	ft-lbs/sec
BTU/min	0.2356	hp
BTU/min	0.01757	kw
BTU/min	7.57	watts
Centimeters	0.3937	inches
cm	0.01	meters
cm	10	mm
Cms Mercury	0.01316	atm
cms Mercury	0.4461	ft water
cms Mercury	136.0	kgs/sq meter
cms Mercury	27.85	lbs/sq ft
cms Mercury	0.1934	lbs/sq in
Cms/Second	1.969	ft/min
cms/Second	0.03281	ft/sec
cms/Second	0.036	km/hr
cms/Second	0.6	meters/min
cms/Second	0.02237	miles/hr
cms/Second	3.728 X 10-4	miles/min
Cms/Sec/Sec	0.03281	ft/sec/sec
Cubic Cms	3.531 X 10-5	cu ft
cu cms	6.102 X 10-2	cu in
cu cms	10-6	cu meters
cu cms	1.308 X 10-6	cu yds
cu cms	2.642 X 10-4	gals
cu cms	10-3	liters
cu cms	2.113 X 10-3	pints (liq)
cu cms	1.057 X 10-3	quarts (liq)
Cubic Feet	2.832 X 104	cubic cms
cu ft	1728	cu inches
cu ft	0.02832	cu meters
cu ft	0.03704	cu yds
cu ft	7.48052	gals
cu ft	28.32	liters
cu ft	59.84	pints (liq)
cu ft	29.92	quarts (liq)
Cu Ft/min	472.0	cu cms/sec
cu ft/min	0.1247	gals/sec
cu ft/min	0.4720	liters/sec
cu ft/min	62.43	lbs w/min

MULTIPLY	BY	OBTAIN
Cu Ft/Sec	0.646317	Million gals/day
cu ft/sec	448.831	gals/min
Cu inches	16.39	cc cu
ins	5.787 x 10-4	cu ft
cu ins	1.639 x 10-5	cu meters
cu ins	2.143 x 10-5	cu yds
cu ins	4.329 x 10-3	gals
cu ins	1.639 x 10-2	liters
cu ins	0.03463	pints (liq)
cu ins	0.01732	quarts (liq)
Cu Meters	106	cc
cu M	35.31	cu ft
cu M	61.023	cu ins
cu M	1.308	cu yds
cu M	264.2	gals
cu M	103	liters
cu M	2113	pints (liq)
cu M	1057	quarts (liq)
cu M	7.646 x 105	cu cms
Cu Yards	27	cu ft
cu yds	46.656	cu ins
cu yds	0.7646	cu meters
cu yds	202.0	gals
cu yds	764.6	liters
cu yds	1616	pints (liq)
cu yds	807.9	quarts (liq)
cu yds	0.1	meters
Decimeters	60	minutes
Degs (Angle)	0.01745	radians
degs (angle)	3600	secs
degs (angle)	0.01745	radians/sec
Degrees Sec	0.1667	revs/min
degs/sec	0.002778	revs/sec
degs/sec	6	ft
Fathoms	30.48	cms
Feet	12	ins
ft	0.3048	meters
ft	1/3	yds
ft	0.02950	atms
Ft of Water	0.8876	ins mercury
ft of w	0.08048	kgs/sq cm
ft of w	62.43	lbs/sq ft
ft of w	0.4335	lbs/sq in
ft of w	0.5080	cms/sec
Feet/Min	0.01667	ft/sec
ft/min	0.01829	kms/hrs
ft/min	0.3040	Ms/min
ft/min	0.01136	miles/hr
ft/min	30.48	cms/sec/sec
Ft/Sec/Sec	0.3048	ms/sec/sec

Conversion Factors

MULTIPLY	BY	OBTAIN
Ft Pounds.	1.286 x 10 ⁻³	BTU's
ft lbs	5.050 x 10 ⁻⁷	hp-hrs
ft lbs	3.241 x 10 ⁻⁴	kg-calories
ft lbs.	0.1383	kg-meters
ft lbs.	3.766 x 10 ⁻⁷	kw-hrs
Ft-Lbs/Min.	1.286 x 10 ⁻³	BTUs/min
ft-lbs/min.	0.01667	ft-lbs/sec
ft-lbs/min.	3.030 x 10 ⁻⁵	hp
ft-lbs/min.	3.241 x 10 ⁻⁴	kg-calories/min
ft-lbs/min.	2.260 x 10 ⁻⁵	kws
Ft-Lbs/Sec.	7.717 x 10 ⁻³	BTUs/min
ft-lbs/sec.	1.818 x 10 ⁻³	hp
ft-lbs/sec.	1.945 x 10 ⁻²	kg-calories/min
ft-lbs/sec.	1.356 x 10 ⁻³	kws
Gallons.	3785.	ccs
gals.	0.1337	cu ft
gals.	231	cu ins
gals.	3.784 x 10 ⁻³	cu meters
gals.	3.785.	liters
gals.	8.	pints (liq)
gals.	4.	quarts (liq)
Gallons, Imp.	1.20095.	US gals
Gallons, US.	0.83267.	imp gals
Gallons Water.	8.3453.	lbs water
Gallons/Min.	2.228 x 10 ⁻³	cu ft/sec
gals/min.	0.06308.	liter/sec
gals/min.	8.0208.	cu ft/hr
Gals Water/Min.	6.0086.	tons water/24 hrs
Grams.		dynes
grams.		grains
grams.	10 ⁻³ .	kgs
grams.	103.	milligrams
grams.	0.03527.	ozs
grams.	0.03215.	ozs (troy)
grams.	2.205 x 10 ⁻³ .	lbs
Grams/Cm.	5.600 x 10 ⁻³ .	lbs/in
Grams/Cu Cm.	62.43.	lbs/cu ft
grams/cu cm.	0.03613.	lbs/cu in
Grams/Liter.	58.417.	grains/gal
grams/liter.	8.345.	lbs/1000 gals
grams/liter.	0.062427.	lbs/cu ft
grams/liter.	1000.	parts/million
Horsepower.	42.44.	BTUs/min
hp.	33.000.	ft-lbs/min
hp.	550.	ft-lbs/sec
hp.	1.014.	hp (metric)
hp.	10.70.	kg-calories/min
hp.	0.7457.	kws
hp.	745.7.	watts

MULTIPLY	BY	OBTAIN
Hp-Hours.	2547.	BTU's
hp-hrs.	1.98 x 106.	ft-lbs
hp-hrs.	641.7.	kg-calories
hp-hrs.	2.737 x 105.	kg-meters
hp-hrs.	0.7457.	kw-hrs
Inches.	2.540.	cms
Ins Mercury.	0.03342.	atms
ins mercury.	1.133.	ft water
ins mercury.	0.03453.	kgs/sq cm
ins mercury.	70.73.	lbs/sq ft
Ins of Water.	0.4912.	lbs/sq in
ins of w.	0.002458.	atms
ins of w.	0.07355.	ins mercury
ins of w.	0.002540.	kgs/sq cm
ins of w.	0.5781.	ozs/sq in
ins of w.	5.202.	lbs/sq ft
Kilograms.	0.03613.	lbs/sq in
kgs.	980.665.	dynes
kgs.	2.205.	lbs
kgs.	1.102 x 10 ⁻³ .	tons (short)
Kgs/Sq CM.	103.	grams
kgs/sq cm.	0.968.	atms
kgs/sq cm.	32.81.	ft water
kgs/sq cm.	28.96.	ins mercury
kgs/sq cm.	20.48.	lbs/sq ft
Kiloliters.	14.22.	lbs/sq ft
Kilometers.	103.	Liters
kms.	105.	Cms
kms.	3281.	Ft
kms.	103.	Meters
Kms Hr.	0.6214.	Miles
kms hr.	27.78.	cms/sec
kms hr.	54.68.	ft/min
kms hr.	0.9113.	ft/sec
kms hr.	16.67.	meters/min
Kms/Hr Sec.	0.6214.	miles/hr
kms/hr sec.	27.78.	cms/sec/sec
kms/hr sec.	0.9113.	ft/sec/sec
kms/hr sec.	0.2778.	Ms/sec/sec
Kilowatts.	56.92.	BTUs/min
kws.	4.425 x 104.	ft-lbs/min
kws.	737.6.	ft-lbs/sec
kws.	1.341.	hp
kws.	14.34.	kg-calories/min
kws.	103.	watts
Killowatt-Hrs.	3415.	BTUs
kw-hrs.	2.6655 x 106.	ft-lbs
kw-hrs.	1.341.	hp-hours
kw-hrs.	860.5.	kg-calories
kw-hrs.	3.671 x 105.	kg-meters

Conversion Factors

MULTIPLY	BY	OBTAIN
Liters	103	ccs
liters	0.03531	cu ft
liters	61.02	cu ins
liters	10-2	cu meters
liters	0.2642	gals
liters	1.057	quarts (liq)
Liters/Min.	4.403 x 10-3	gals/sec
Meters	100	cms
meters	3.281	ft
meters	39.37	ins
meters	10-3	kms
meters	103	mms
Meters/Min.	1.667	cms/sec
meters/min.	3.281	ft/min
meters/min.	0.05468	ft/sec
meters/min.	0.06	kms/hr
meters/min.	0.03728	miles/hr
Meters/Sec.	196.8	ft/min
meters/sec.	3.281	ft/sec
meters/sec.	3.6	kms/hr
meters/sec.	0.06	kms/min
meters/sec.	2.237	miles/hr
meters/sec.	0.03728	miles/min
Microns	10-6	meters
Microns	25.400	in
Miles/Hr.	4.70	cms/sec
miles/hr.	88	ft/min
miles/hr.	1.467	ft/sec
miles/hr.	1.609	kms/hr
miles/hr.	0.8684	knots
miles/hr.	26.82	meters/min
Millimeters	0.1	cms
mms.	0.03937	ins
Mins (Ange)	2.909 x 10-4	radians
Ounces	16	drams
ozs.	437.5	grains
ozs.	0.0625	lbs
ozs.	28.349527	grams
ozs.	0.9115	ozs (troy)
ozs.	2790 x 10-5	tons (long)
ozs.	2.835 x 10-5	tons (metric)
Ozs (Fluid)	1.805	cu in
ozs (fluid)	0.02957	liters
Pounds	16	ozs
lbs.	256	drams
lbs.	7000	grains
lbs.	0.0005	tons (short)
lbs.	453.5924	grams
lbs.	1.21528	lbs (troy)
lbs.	14.5833	ozs (troy)

MULTIPLY	BY	OBTAIN
Lbs of Water	0.01602	cu ft
lbs of water	27.68	cu in
lbs of water	0.1198	gals
Lbs of w/Min.	2.679 x 10-4	cu ft/sec
Pounds/Cu ft.	5.787 x 10-4	lbs/cu in
Pounds/Cu In.	1728	lbs/cu ft
Pounds/Sq In.	0.06804	atms
lbs/sq in.	2.307	ft water
lbs/sq in.	2.036	in mercury
lbs/sq in.	0.07031	kgs/sq cm
Radians	57.29578	degrees
Tons (Long)	1016	kgs
tons (long)	2240	lbs
tons (long)	1.12000	tons (short)
Tons (Short)	2000	lbs
tons (short)	907.18486	kgs
tons (short)	2430.56	lbs (troy)
tons (short)	0.89287	tons (long)
tons (short)	29166.66	ozs (troy)
tons (short)	0.90718	tons (metric)
Watts	0.05692	BTUs/min
watts	44.26	ft-lbs/min
watts	0.7376	ft-lbs/sec
watts	1.341 x 10-3	hp
watts	0.01434	kg-calories/min
watts	10-3	kws
Watt-Hours	3.415	BTUs
watt-hrs.	2655	ft-lbs
watt-hrs.	1.341 x 10-3	hp-hrs
watt-hrs.	0.8605	kg-calories
watt-hrs.	367.1	kg-meters
watt-hrs.	10-3	kw-hrs

Tools and Resources

FORMULAS - ELECTRICAL

VOLTS =

$$\frac{\text{Watts}}{\text{Amps}} = \text{Volts}$$

AMPS =

$$\frac{\text{Watts}}{\text{Volts}} = \text{Amps}$$

WATTS =

$$\text{Volts} \times \text{Amps} = \text{Watts}$$

OHMS =

$$\frac{\text{Volts}^2}{\text{Watts}} = \text{Ohms}$$

Power Factor = $\frac{\text{KW}}{\text{KVA}} = \text{Cos } \Theta$

Single Phase

$$\text{KW} = \frac{\text{A} \times \text{V} \times \text{PF}}{1000}$$

$$\text{KVA} = \frac{\text{V} \times \text{A}}{1000}$$

$$\text{Amps} = \frac{\text{KVA} \times 1000}{\text{V}}$$

$3 = 1.73$

Approx. Motor KVA = Motor Horsepower (At Full Load)

Capacitors Connected in Parallel

Capacitors Connected in Series

For Two

$$\frac{C_1 \times C_2}{C_1 + C_2} = \text{C Total}$$

Three Phase

$$\text{KW} = \frac{3 \times \text{V} \times \text{A} \times \text{PF}}{1000}$$

$$\text{KVA} = \frac{3 \times \text{V} \times \text{A}}{1000}$$

$C_1 + C_2 + C_3 = \text{C Total}$

More Than Two

$$1 \frac{1}{C_2 C_2 C_2} = \text{C Total}$$

VOLTAGE UNBALANCE

$$\% \text{ Voltage Unbalance} = \frac{100 \times \text{Max Voltage Deviation from Average Voltage}}{\text{Average Voltage}}$$

BOOST TRANS:

$$\frac{\text{Rating Plate F.L.A.} \times \text{Rating Plate VOLTS} - \text{KVA}}{\text{Rating Plate VOLTS}} = \text{FACTOR}$$

Rating Plate VOLTS - Norm. Line VOLT

$$\text{KVA} = \text{TRANS. KVA RATING} \times \text{FACTOR}$$

$$\frac{V_2}{V_1} = 2 \times \text{Heater Rating} = \text{Rating @ New Voltage}$$

$V_1 =$ Rated Volts

$V_2 =$ Measured Volts

Typical Ampere Wire Ratings* Copper Conductors, in Conduit*			
AWG MCM	TEMP RATING OF CONDUCTOR		
	60°C*	75°C*	90°C*
14	15	15	25°
12	20	20	30°
10	30	30	40°
8	40	45	50
6	55	65	70
4	70	85	90
3	80	100	105
2	95	115	120
1	110	130	140
1/0	125	150	155
2/0	145	175	185
3/0	165	200	210
4/0	195	230	235
250	215	255	270
300	240	285	300
350	260	310	325
400	280	335	360
500	320	380	405
600	355	420	455
700	385	460	490
750	400	475	500
800	410	490	515
900	435	520	555
1000	455	545	585
1250	495	590	645
1500	520	625	700
1750	545	650	735
2000	560	665	775

*Summary only, refer to NEC 310-16, -17, -18, -19 (and others) for limitations.

Typical Electric Wire Size				
MOTOR HP	SINGLE PH.		THREE PH.	
	115 VOLT	230 VOLT	230 VOLT	460 VOLT
1-1/3	14	14		
1/2	14	14	14	14
3/4	12	14	14	14
1	12	14	14	14
1-1/2	10	14	14	14
2		12	14	14
3		10	14	14
5			12	14
7-1/2			10	14
10			8	12

From Standards of the National Board of Fire Underwriters.

Correction Table For Watts - Amperes - Volts				
WATTS	VOLTAGE (C - SINGLE PHASE)			
	120	208	240	277
	AMPERES			
500	4.2	2.4	2.1	1.8
1000	8.3	4.8	4.2	3.6
1500	12.5	7.2	6.3	5.4
2000	16.7	9.6	8.3	7.2
2500	20.9	12.0	10.4	9.0
3000	25.0	14.4	12.5	10.8

ELECTRICAL UNITS

Source: United States Bureau of Standards

The watt is the unit expressing electrical power as horsepower (hp) in mechanics; it is equal to the product of the volts (pressure) times amperes (rate of flow). Thus, 2 volts times 2 amperes would equal 4 watts in a direct current circuit. Electrical energy is sold at so much per watt hour or more generally at a given amount per kilowatt hour - which means 1,000 watt hours. this may represent 1 watt for 1,000 hours or 1,000 watts for one hour. 746 watts are equal to one horsepower or inversely 1 kilowatt (kw) is equal to about 1-1/2 horsepower.

Horsepower represents the power required to lift a weight of 33,000 lbs. 1 foot in 1 minute or 550 lbs. 1 foot in 1 second.

The ohm is the unit of electrical resistance and represents the physical property of a conductor which offers a resistance to the flow of electricity, permitting just 1 ampere to flow at 1 volt of pressure.

ELECTRICAL UNITS CORRECTION FACTOR

HEATING CORRECTION FACTOR

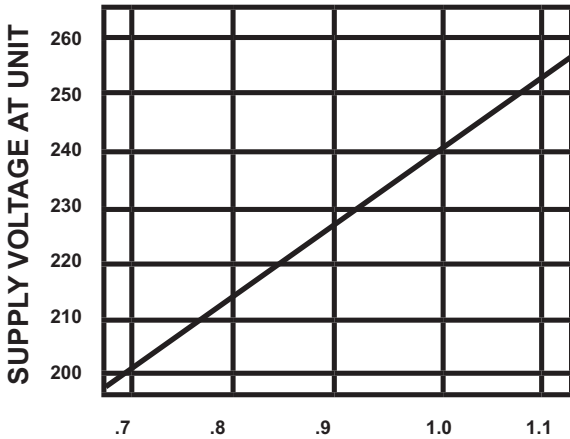

Capacity Correction Factor

For correction of unit output, multiply the correction factor times the KW rating at 240 volts.

$$TR = 3160 \times KW \times VC \quad \text{or} \quad CFM = 3160 \times KW \times VC$$

CFM TR

Where: TR = temp. rise, F°
 3160 = constant
 KW = KW rating above
 CFM = air flow at specified conditions
 VC = heating correction factor

FORMULAS - COOLING CAPACITY*

$$\text{Total BTUH} = CFM \times (THC_1 - TCH_2) \times 4.5$$

TCH = Total Heat Content or Enthalpy (BTU. per lb of air)

$$\text{Sensible BTUH} = CFM (T_1 - T_2) \times 1.08$$

T = Dry Bulb Temp (Degrees Fahrenheit)

$$\text{Latent BTUH} = CFM (W_1 - W_2) \times .683$$

W = Specific Humidity (Grains H₂O per lb. of air)
 (See Psychrometrics chart)

* Based on standard air at 13.3 cubic feet per lb.

FORMULAS - HEATING CAPACITY*

$$\text{BTUH} = CFM \times 1.08 \times \text{Rise}$$

$$\text{CFM} = \frac{\text{BTUH Output}}{1.08 \times \text{Rise}}$$

$$\text{Rise} = \frac{\text{BTUH Output}}{1.08 \times \text{CFM}}$$

$$\text{CFM} = \frac{\text{BTU/Hr. Input}}{1.35 \times \Delta T} \quad \text{Indoor Furnace 80\%}$$

$$\text{CFM} = \frac{\text{BTU/Hr. Input}}{1.44 \times \Delta T} \quad \text{Outdoor Furnace 75\%}$$

$$\text{CFM} = \frac{\text{KW} \times 3415}{1.08 \times \Delta T} \quad \text{Electric Heat 92\%}$$

* Based on standard air at 13.3 cubic feet per lb.

Formulas - General Subjects

Area of Circle = 0.7854 (Dia.)²
 Circumference of Circle = 3.14 x Dia.
 Area of Sphere = 3.14 x (Dia.)²
 Volume of Sphere 0.524 x (Dia.)³

Horsepower Conversion Chart

To convert decimal horsepower to commonly available fractional horsepower motors.

DECIMAL HORSEPOWER																	
0.010	0.014	0.017	0.020	0.025	0.033	0.040	0.050	0.067	0.083	0.100	0.125	0.167	0.250	0.333	0.500	0.750	1.000
FRACTIONAL HORSEPOWER																	
1/100	1/70	1/60	1/50	1/40	1/30	1/25	1/20	1/15	1/12	1/10	1/8	1/6	1/4	1/3	1/2	3/4	1

Typical Motor Ampere Values

NOMINAL HORSEPOWER	SINGLE PHASE				THREE PHASE					
	115V		230V		230V		460V		575V	
	FLA	LRA	FLA	LRA	FLA	LRA	FLA	LRA	FLA	LRA
1/6	4.4		2.2		-	-	-	-	-	-
1/4	5.8		2.9		-	-	-	-	-	-
1/3	7.2		3.6		-	-	-	-	-	-
1/2	9.8	58.8	4.9	29.4	2	12	1	6	0.8	4.8
3/4	13.8	82.8	6.9	41.4	2.8	16.8	1.4	8.4	1.1	6.6
1	16	96	8	48	3.6	21	1.8	10.8	1.4	8.4
1-1/2	20	120	10	60	5.2	30	2.6	15	2.1	12
2	24	144	12	72	6.8	39	3.4	19.8	2.7	15.6
3	34	204	17	102	9.6	54	4.8	27	3.9	24
5	56	336	28	168	15.2	90	7.6	45	6.1	36
7-1/2	80	480	40	240	22	132	11	66	9	54
10	100	600	50	300	28	162	14	84	11	66
15	-	-	-	-	42	240	21	120	17	96
20	-	-	-	-	54	312	27	156	22	126
25	-	-	-	-	68	384	34	192	27	156
30	-	-	-	-	80	468	40	234	32	186
40	-	-	-	-	104	624	52	312	41	246
50	-	-	-	-	130	750	65	378	52	300
60	-	-	-	-	154	900	77	450	62	360
75	-	-	-	-	192	1110	96	558	77	444
100	-	-	-	-	248	1476	124	738	99	588
125	-	-	-	-	312	1860	156	930	125	744
150	-	-	-	-	360	2160	180	1080	144	864
200	-	-	-	-	480	2880	240	1440	192	1152

* Source: 1975 National Electrical Code. Tables 430-148, -150, -151. See applicable notes regarding 200V & 208V. Data presented as a guide only.

Insulation Factors

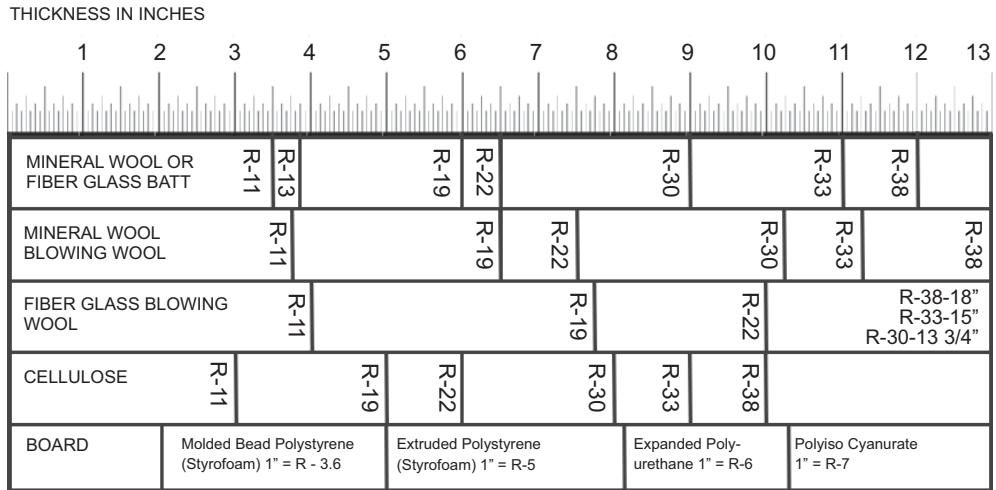

Determine "R" value of walls, ceilings and floors. For walls that have more than one type of insulation, add the "R" values of each to obtain total "R". Example: Frame wall w/ 3" batt and 1" expanded polyurethane.

Residential Duct Sizing Guide

The following duct sizes are based on a fraction drop of .10 inches per 100 feet of lineal duct. This "Equal-Friction" method of duct sizing should be adequate for normal residential furnace heating and air conditioning applications. Larger air volumes or higher static pressures should be dealt with on an individual job basis.

Rectangular and Round Duct

AIR VOLUME	DUCT HEIGHT INCHES					EQUIVALENT ROUND	AIR VOLUME
	4"	6"	8"	10"	12"		
50	6 X 4					5	50
75	6 X 4					6	75
100	8 X 4	6 X 6				6	100
125	10 X 4	6 X 6				7	125
150	10 X 4	8 X 6				7	150
175	12 X 4	8 X 6				8	175
200	14 X 4	8 X 6				8	200
225	16 X 4	10 X 6				8	225
250	16 X 4	10 X 6				9	250
275		12 X 6	8 X 8			9	275
300		12 X 6	8 X 8			9	300
400		14 X 6	10 X 8			10	400
500		18 X 6	12 X 8	10 X 10		11	500
600		20 X 6	14 X 8	12 X 10		12	600
700		24 X 6	16 X 8	12 X 10		12	700
800		26 X 6	18 X 8	14 X 10	12 X 12	13	800
900		30 X 6	20 X 8	16 X 10	12 X 12	14	900
1000			22 X 8	16 X 10	14 X 12	14	1000
1100			24 X 8	18 X 10	16 X 12	15	1100
1200			26 X 8	20 X 10	16 X 12	15	1200
1300			28 X 8	20 X 10	18 X 12	16	1300
1400			30 X 8	22 X 10	18 X 12	16	1400
1500				24 X 10	20 X 12	16	1500
1600				24 X 10	20 X 12	17	1600
1700				26 X 10	22 X 12	17	1700
1800				28 X 10	22 X 12	18	1800
1900				30 X 10	22 X 12	18	1900
2000					24 X 12	18	2000

$$\text{Driven Pulley Diam.} = \frac{\text{Motor Pulley Diam. RPM}}{\text{Driven Pulley RPM}}$$

$$\text{Driven Pulley RPM} = \frac{\text{Motor RPM Motor Pulley Diam.}}{\text{Driven Pulley Diam.}}$$

$$\text{Motor Pulley Diam.} = \frac{\text{Driven Pulley Diam.} \times \text{RPM}}{\text{Motor RPM}}$$

$$\text{Motor RPM} = \frac{\text{Driven Pulley Diam.} \times \text{RPM}}{\text{Motor Pulley Diam.}}$$

$$L = \frac{D + d}{2} \times \pi + 2x$$

Where:
 L = Length of Belt
 D = Diameter of Large Pulley
 d = Diameter of Small Pulley
 x = Center to Center Distance
 $\pi = 3.1416$

Tools and Resources

Useful Data

Nominal Air Flow

Cooling 400 CFM Per Ton
 Heating 12 CFM Per 1000 BTU Input

Approx. Heat Values: BTUs

Fuel oil/gal #1 = 135,800

#2 = 139,400

#3 = 141,800

Gas Pressure

(Inches of water to ounces)

1" W.C. = .58 oz.

1.73" W.C. = 1 oz.

3.5" W.C. = 2 oz.

10.5" W.C. = 6.1 oz.

27.71" W.C. = 1 lb.

Watts of Heat

1 Watt = 3.413 BTU.

BTU = Watts x 3.143

Formula For Figuring Capacity in Gallons - Round Tanks

Multiply Square of the diameter in inches by .7854. Multiply the result by length in inches, which will give you the volume of tank in inches, which will give you the volume of tank in inches. Since there are 231 cubic inches in one gallon you divide the inch volume by 231. The answer is capacity in gallons.

ARI Conditions

(Air entering)

Evaporator 80°F DB / 67°F WB

Condenser 90°F DB

Centrifugal Blower and Pump Laws

Capacity varies directly as speed
 Pressure varies directly as (speed)²
 Power varies directly as (speed)³

$$\text{New CFM} = \frac{\text{Old CFM} \times \text{New RPM}}{\text{Old RPM}} \quad \text{Pump HP} = \frac{\text{GPM} \times \text{Total Head}}{3960 \times \text{Pump Efficiency}}$$

$$\text{New Static Pressure} = \text{Old Static Pressure} \times \left(\frac{\text{New RPM}}{\text{Old RPM}} \right)^2 \quad \text{New RPM} = \text{Present RPM} \times \left(\frac{\text{New CFM}}{\text{Present CFM}} \right)$$

$$\text{New HP} = \text{Old HP} \times \left(\frac{\text{New RPM}}{\text{Old RPM}} \right)^3 \quad \text{New SP} = \text{Present SP} \times \left(\frac{\text{New CFM}}{\text{Present CFM}} \right)^2$$

$$\text{Shaft HP} = \frac{\text{Ft.-Lbs. Torque} \times \text{RPM}}{5250} \quad \text{New HP} = \text{Present HP} \times \left(\frac{\text{New CFM}}{\text{Present CFM}} \right)^3$$

Tank Gauge Charts

275 GALLON 44" X 27" X 60" VERTICAL		275 GALLON 44" X 27" X 60" HORIZONTAL		285 GALLON 38" X 60"		550 GALLON 48" X 72"		1000 GALLON 48" X 128"	
INCHES	GALLONS	INCHES	GALLONS	INCHES	GALLONS	INCHES	GALLONS	INCHES	GALLONS
2	5	2	14	1	3	1	3	1	5
4	14	4	32	2	6	2	8	2	14
6	25	6	51	3	11	3	15	3	26
8	37	8	73	4	17	4	22	4	40
10	50	10	96	5	23	5	31	5	55
12	65	12	118	6	30	6	41	6	72
14	79	14	146	7	37	7	51	7	91
16	93	16	169	8	45	8	62	8	110
18	107	18	191	9	53	9	73	9	130
20	122	20	213	10	62	10	85	10	151
22	136	22	235	11	71	11	97	11	173
24	150	24	253	12	80	12	110	12	196
26	164	26	275	13	89	13	123	13	219
28	178			14	99	14	137	14	243
30	193			15	108	15	151	15	267
32	207			16	118	16	165	16	292
34	221			17	128	17	179	17	317
36	234			18	137	18	193	18	343
38	246			19	147	19	208	19	369
40	258			20	157	20	222	20	395
42	268			21	167	21	237	21	421
44	275			22	177	22	252	22	447
				23	186	23	267	23	474
				24	196	24	282	24	501
				25	206	25	297	25	528
				26	215	26	312	26	555
				27	224	27	327	27	581
				28	233	28	342	28	607
				29	241	29	356	29	633
				30	249	30	371	30	659
				31	257	31	385	31	685
				32	265	32	399	32	710
				33	272	33	413	33	735
				34	278	34	427	34	759
				35	284	35	441	35	783
				36	289	36	454	36	806
				37	292	37	467	37	829
				38	295	38	479	38	851
						39	491	39	872
						40	502	40	892
						41	513	41	911
						42	523	42	930
						43	533	43	947
						44	542	44	962
						45	549	45	976
						46	556	46	988
						47	561	47	997
						48	564	48	1002

Enthalpy vs. Wetbulb

(Total heat content - BTU per lb. of air)

WET BULB F	TENTHS OF DEGREES									
	0	.1	.2	.3	.4	.5	.6	.7	.8	.9
35	13.01	13.05	13.09	13.14	13.18	13.22	13.27	13.31	13.35	13.39
36	13.44	13.48	13.52	13.57	16.61	13.66	13.70	13.74	13.79	13.83
37	13.87	13.92	13.96	14.01	14.05	14.10	14.14	14.19	14.23	14.27
38	14.32	14.36	14.41	14.45	14.50	14.54	14.59	14.63	14.68	14.73
39	14.77	14.82	14.86	14.91	14.95	15.00	15.05	15.09	15.14	15.18
40	15.23	15.28	15.32	15.37	15.42	15.46	15.51	15.56	15.60	15.65
41	15.70	15.74	15.79	15.84	15.89	15.93	15.98	16.03	16.08	16.12
42	16.17	16.22	16.27	16.32	16.37	16.41	16.46	16.51	16.56	16.61
43	16.66	16.71	16.75	16.80	16.85	16.90	16.95	17.00	17.05	17.10
44	17.15	17.20	17.25	17.30	17.35	17.40	17.45	17.50	17.55	17.60
45	17.65	17.70	17.75	17.80	17.85	17.91	17.96	18.01	18.06	18.11
46	18.16	18.21	18.26	18.32	18.37	18.42	18.47	18.52	18.58	18.63
47	18.68	18.73	18.79	18.84	18.89	18.95	19.00	19.05	19.10	19.16
48	19.21	19.26	19.32	19.37	19.43	19.48	19.53	19.59	19.64	19.70
49	19.75	19.81	19.86	19.92	19.97	20.03	20.08	20.14	20.19	20.25
50	20.30	20.36	20.41	20.47	20.52	20.58	20.64	20.69	20.75	20.81
51	20.86	20.92	20.98	21.03	21.09	21.15	21.21	21.26	21.32	21.38
52	21.44	21.49	21.55	21.61	21.67	21.73	21.79	21.84	21.90	21.96
53	22.02	22.08	22.14	22.20	22.26	22.32	22.38	22.44	22.50	22.56
54	22.61	22.68	22.74	22.80	22.86	22.92	22.98	23.04	23.10	23.16
55	23.22	23.28	23.34	23.41	23.47	23.53	23.59	23.65	23.72	23.78
56	23.84	23.90	23.97	24.03	24.10	24.16	24.22	24.29	24.35	24.42
57	24.48	24.54	24.61	24.67	24.74	24.80	24.86	24.93	24.99	25.06
58	25.12	25.19	25.25	25.32	25.38	25.45	25.52	25.58	25.65	25.71
59	25.78	25.85	25.92	25.98	26.05	26.12	26.19	26.26	26.32	26.39
60	26.46	26.53	26.60	26.67	26.74	26.80	26.87	26.94	27.01	27.08
61	27.15	27.22	27.29	27.36	27.43	27.50	27.57	27.64	27.71	27.78
62	27.85	27.92	27.99	28.07	28.14	28.21	28.28	28.35	28.43	28.50
63	28.57	28.64	28.72	28.79	28.87	28.94	29.01	29.09	29.16	29.24
64	29.31	29.38	29.46	29.53	29.61	29.68	29.76	29.83	29.91	29.98
65	30.06	30.14	30.21	30.29	30.37	30.44	30.52	30.60	30.68	30.75
66	30.83	30.91	30.99	31.07	31.15	31.22	31.30	31.38	31.46	31.54
67	31.62	31.70	31.78	31.86	31.94	32.02	32.10	32.18	32.26	32.34
68	32.42	32.50	32.59	32.67	32.75	32.83	32.92	33.00	33.08	33.17
69	33.25	33.33	33.42	33.50	33.59	33.67	33.75	33.84	33.92	34.00
70	34.09	34.18	34.26	34.35	34.43	34.52	34.61	34.69	34.79	34.86
71	34.95	35.04	35.13	35.21	35.30	35.39	35.48	35.57	35.65	35.74
72	35.83	35.92	36.01	36.10	36.19	36.28	36.38	36.47	36.56	36.65
73	36.74	36.83	36.92	37.02	37.11	37.20	37.29	37.38	37.48	37.57
74	37.66	37.75	37.85	37.94	38.04	38.13	38.23	38.32	38.42	38.51
75	38.61	38.71	38.80	38.90	39.00	39.09	39.19	39.28	39.38	39.47
76	39.57	39.67	39.77	39.87	39.98	40.07	40.17	40.27	40.37	40.47
77	40.57	40.67	40.77	40.87	40.97	41.07	41.18	41.28	41.38	41.48
78	41.58	41.68	41.79	41.89	42.00	42.10	42.20	42.31	42.41	42.52
79	42.62	42.73	42.83	42.94	43.05	43.15	43.26	43.37	43.48	43.58
80	43.69	43.80	43.91	44.02	44.13	44.23	44.34	44.45	44.56	44.67
81	44.78	44.89	45.00	45.12	45.23	45.34	45.45	45.56	45.68	46.79
82	45.90	46.01	46.13	46.24	46.36	46.47	46.58	46.70	46.81	46.93
83	47.04	47.16	47.28	47.39	47.51	47.63	47.75	47.87	47.98	48.10
84	48.22	48.34	48.46	48.58	48.70	48.82	48.95	49.07	49.19	49.31
85	49.43	49.55	49.68	49.80	49.92	50.04	50.17	50.29	50.41	50.54

Drill Sizes

DRILL NUMBER OR LETTER*	DECIMAL EQUIV.	DRILL NUMBER OR LETTER*	DECIMAL EQUIV.	DRILL NUMBER OR LETTER*	DECIMAL EQUIV.
80	0.0135	40	0.098	2	0.221
79	0.0145	39	0.0995	1	0.228
1/64	0.0156	38	0.1015	A	0.234
78	0.016	27	0.104	15/64	0.2344
77	0.018	36	0.1065	B	0.238
76	0.020	7/64	0.1094	C	0.242
75	0.021	35	0.110	D	0.246
74	0.0225	34	0.111	E & 1/4	0.250
73	0.024	33	0.113	F	0.257
72	0.025	32	0.116	G	0.261
71	0.026	31	0.120	17/64	0.2656
70	0.028	1/8	0.1250	H	0.266
69	0.0292	30	0.1285	I	0.272
68	0.031	29	0.136	J	0.277
1/32	0.0312	28	0.1405	K	0.281
67	0.032	9/64	0.1406	9/32	0.2812
66	0.033	27	0.144	L	0.290
65	0.035	26	0.147	M	0.295
64	0.036	25	0.195	19/64	0.2969
63	0.037	24	0.152	N	0.302
62	0.038	23	0.154	5/16	0.3125
61	0.039	5/32	0.1562	O	0.316
60	0.40	22	0.157	P	0.323
59	0.041	21	0.159	21/64	0.3281
58	0.042	20	0.161	Q	0.332
57	0.043	19	0.166	R	0.339
56	0.0465	18	0.1695	11/32	0.3437
3/64	0.0468	11/64	0.1719	S	0.348
55	0.052	17	0.173	T	0.358
54	0.055	16	0.177	23/64	0.3594
53	0.0595	15	0.180	U	0.368
1/16	0.0625	14	0.182	3/8	0.375
52	0.0635	13	0.185	V	0.377
51	0.067	3/16	0.1875	W	0.386
50	0.070	12	0.189	25/64	0.3906
49	0.073	11	0.191	X	0.397
48	0.076	10	0.1935	Y	0.404
5/64	0.0781	9	0.196	13/32	0.4062
47	0.0785	8	0.199	Z	0.413
46	0.081	7	0.201	27/64	0.4219
45	0.082	13/64	0.2031	7/16	0.4375
44	0.086	6	0.204	29/64	0.4531
43	0.089	5	0.2055	15/32	0.4687
42	0.0935	4	0.209	31/64	0.4844
3/32	0.0937	3	0.213	1/2	0.5000
41	0.096	7/32	0.2187		

NOTE: The shank of a numbered drill makes a good gauge to determine the inside diameter of capillary tubing or to measure gas burner orifices.

Unit Efficiency Ratings

EER is the industry standard in the United States for rating the efficiency of a commercial unit. On some international specifications, however, minimum efficiencies are often listed in COP or KW/TON. To convert our efficiency ratings from EER to COP or KW/TON, you can use the following table:

EER	COP	KW/TON
9.0	2.64	1.33
10.0	2.93	1.20
11.0	3.22	1.09
12.0	3.52	1.00
13.0	3.81	0.92
14.0	4.10	0.86

Example for a unit with a net capacity of 100 MBH and a total power requirement of 10 KW:

$$EER = \frac{100 \text{ MBH}}{10 \text{ KW}} = 10.0 \text{ MBH/KW}$$

$$COP (100 \text{ MBH } 10 \text{ KW}) = 2.93 \text{ (Note: } 3.415 \text{ MBH} = 1 \text{ KW)}$$

$$3.415 \text{ MBH/KW}$$

$$KW/TON = \frac{10 \text{ KW} \times 12 \text{ MBH/TON}}{100 \text{ MBH}} = 1.20 \text{ KW/TON (Note: } 12 \text{ MBH} = 1 \text{ TON)}$$

Temperature Conversion Fahrenheit and Centigrade

To convert Fahrenheit to Celsius (Centigrade)
 $.556 \times (^\circ\text{F} - 32) = ^\circ\text{C}$

To convert Celsius (Centigrade) to Fahrenheit
 $(^\circ\text{C} \times 1.8) + 32 = ^\circ\text{F}$

C°	F°	C°	F°
-30	-22	40	104
-25	-13	45	113
-20	-4	50	122
-15	5	55	131
-10	14	60	140
-5	23	65	149
0	32	70	158
5	41	75	167
10	50	80	176
15	59	85	185
20	68	90	194
25	77	95	203
30	86	100	212
35	95	105	221

APPROX. BTU, GRAVITY & WEIGHT OF FUEL OIL

FUEL NO	AVERAGE BTU'S PER GAL	SPECIFIC GRAVITY	LBS. PER GAL.
1	135,800	38-42	6.8
2	139,400	32-36	7.2
4	145,000	24-26	7.5
5	148,100	18-22	7.7
6	151,300	14-16	7.9

CAPACITIES OF CYLINDRICAL TANKS

DIAMETER INCHES	GALS. PER IN. LENGTH	GALS PER FT. LENGTH
12"	.49	5.88
15"	.76	9.18
18"	1.10	13.22
24"	1.95	23.50
27"	2.47	29.74
30"	3.06	36.70
33"	3.70	44.43
36"	4.40	52.88
42"	5.99	71.97
48"	7.83	94.00
54"	9.91	118.97
60"	12.24	146.88
66"	14.81	177.72
72"	17.63	211.51
84"	23.99	287.88
96"	31.33	376.01
108"	39.66	475.89
120"	48.96	587.52
144"	70.50	846.00

Sensor Resistance vs. Temperature

TEMP. °F	RESIST. (OHMS)	TEMP. °F	RESIST. (OHMS)	TEMP. °F	RESIST. (OHMS)	TEMP. °F	RESIST. (OHMS)	TEMP. °F	RESIST. (OHMS)	TEMP. °F	RESIST. (OHMS)
-10	118,050	38	27,586	86	8,057	134	2,808	182	1,128	229	518
-9	114,230	39	26,831	87	7,868	135	2,751	183	1,108	230	510
-8	110,540	40	26,099	88	7,685	136	2,696	184	1,089	231	502
-7	106,990	41	25,390	89	7,506	137	2,642	185	1,070	232	494
-6	103,560	42	24,703	90	7,332	138	2,589	186	1,051	233	487
-5	100,260	43	24,036	91	7,163	139	2,538	187	1,033	234	479
-4	97,070	44	23,390	92	6,998	140	2,488	188	1,015	235	472
-3	93,994	45	22,763	93	6,838	141	2,438	189	997	236	465
-2	91,027	46	22,155	94	6,682	142	2,390	190	980	237	458
-1	88,162	47	21,566	95	6,530	143	2,343	191	963	238	451
0	85,398	48	20,994	96	6,381	144	2,297	192	947	239	445
1	82,730	49	20,439	97	6,237	145	2,252	193	931	240	438
2	80,154	50	19,900	98	6,097	146	2,208	194	915	241	431
3	77,668	51	19,377	99	5,960	147	2,166	195	899	242	425
4	75,268	52	18,870	100	5,827	148	2,124	196	884	243	419
5	72,950	53	18,377	101	5,697	149	2,083	197	869	244	412
6	70,712	54	17,899	102	5,570	150	2,042	198	855	245	406
7	68,550	55	17,435	103	5,447	151	2,003	199	841	246	400
8	66,462	56	16,985	104	5,327	152	1,965	200	827	247	395
9	64,444	57	16,547	105	5,209	153	1,927	201	813	248	389
10	62,495	58	16,122	106	5,095	154	1,891	202	799	249	383
11	60,611	59	15,710	107	4,983	155	1,855	203	786	250	378
12	58,791	60	15,309	108	4,875	156	1,820	204	773	251	372
13	57,031	61	14,920	109	4,768	157	1,785	205	761	252	367
14	55,330	62	14,542	110	4,665	158	1,752	206	748	253	361
15	53,685	63	14,175	111	4,564	159	1,719	207	736	254	356
16	52,095	64	13,818	112	4,466	160	1,686	208	724	255	351
17	50,557	65	13,472	113	4,370	161	1,655	209	712	256	346
18	49,070	66	13,135	114	4,276	162	1,624	210	700	257	341
19	47,632	67	12,808	115	4,184	163	1,593	211	689	258	336
20	46,240	68	12,490	116	4,095	164	1,564	212	678	259	332
21	44,894	69	12,181	117	4,008	165	1,535	213	667	260	327
22	43,591	70	11,881	118	3,923	166	1,506	214	656	261	322
23	42,330	71	11,589	119	3,840	167	1,479	215	646	262	318
24	41,110	72	11,305	120	3,759	168	1,451	216	635	263	313
25	39,929	73	11,030	121	3,680	169	1,425	217	625	264	309
26	38,785	74	10,761	122	3,603	170	1,399	218	615	265	305
27	37,678	75	10,501	123	3,527	171	1,374	219	606	266	300
28	36,607	76	10,247	124	3,454	172	1,349	220	596	267	296
29	35,569	77	10,000	125	3,382	173	1,324	221	587	268	292
30	34,565	78	9,759	126	3,312	174	1,301	222	578	269	288
31	33,592	79	9,526	127	3,243	175	1,277	223	569	270	284
32	32,650	80	9,298	128	3,177	176	1,255	224	560	271	280
33	31,738	81	9,077	129	3,111	177	1,232	225	551	272	276
34	30,854	82	8,862	130	3,048	178	1,210	226	542	273	273
35	29,998	83	8,653	131	2,986	179	1,189	227	534	274	269
36	29,168	84	8,449	132	2,925	180	1,168	228	526	275	265
37	28,364	85	8,250	133	2,866	181	1,148				

Capillary Tube Length Conversion Chart

Enables users of capillary tubing to use the more prevalent tubing sizes which are readily available. While many original equipment manufacturers and condensing unit manufacturers recommend specific lengths and diameters of capillary tubing for their units, these tube sizes are not always readily available except on special order. This conversion chart enables the user to translate the recommended length into a tube diameter that can be quickly obtained. In using the chart it is recommended that conversions be made using factors within the unshaded area.

To Use Chart

- (1) Locate original cap tube I.D. in left hand column.
- (2) Read across and find conversion factor under New I.D. cap tube size. Conversion factors in unshaded area show range of new I.D. Cap. Tubes recommended.
- (3) Multiply the length of the original cap tube by the conversion factor.
- (4) The resultant length of cap tube will approximate the same flow characteristics as the original cap tube.

Example

Original cap tube: .055" I.D. x 65"

Locate .055 in left hand column and read across in unshaded areas to locate the conversion factors. Multiply the original cap tube length, (65"), by the conversion factors to get the correct length for the new I.D.

NEW I.D.	FACTOR	LENGTH
.049	.59	38.4"
.050	.64	41.6"
.054	.92	59.8"
.055	1.00	65.0"
.059	1.38	89.7"

Any of these cap tubes will approximate the same results as the original cap tube.

Capillary Tube Length Conversion Chart

NEW ID	.042	.044	.049	.050	.054	.055	.059	.064	.070	.075	.080	.085	.090	.100
ORIG. ID														
.035	2.31													
.036	2.10													
.037	1.79	2.22												
.038	1.59	1.92												
.039	1.41	1.75												
.040	1.25	1.55	2.51											
.041	1.12	1.38	2.26	2.50										
.042	1.00	1.24	2.03	2.23										
.043	.87	1.11	1.83	1.98										
.044	.81	1.00	1.62	1.79										
.045	.73	.90	1.47	1.60	2.32									
.046	.67	.82	1.34	1.47	2.08	2.27								
.047	.59	.74	1.20	1.31	1.89	2.06								
.048	.54	.67	1.10	1.20	1.72	1.87								
.049	.49	.61	1.00	1.09	1.55	1.69								
.050	.45	.56	.91	1.00	1.43	1.56	2.14							
.051	.41	.51	.84	.93	1.31	1.44	1.96							
.052		.47	.76	.85	1.19	1.32	1.78							
.053		.43	.69	.78	1.09	1.20	1.64							
.054		.39	.65	.70	1.00	1.09	1.52	2.18						
.055		.36	.59	.64	.92	1.00	1.38	2.00						
.056			.54	.60	.85	.94	1.27	1.85						
.057			.50	.55	.79	.87	1.17	1.72						
.058			.46	.51	.73	.80	1.07	1.56						
.059			.42	.47	.67	.73	1.00	1.44	2.18					
.060			.39	.43	.62	.67	.93	1.33	2.04					
.064				.32	.47	.50	.69	1.00	1.50	2.07				
.070					.30	.33	.46	.67	1.00	1.37	1.84			
.075								.48	.73	1.00	1.37	1.75		
.080									.54	.74	1.00	1.32	1.71	
.085										.57	.76	1.00	1.29	
.090										.43	.62	.76	1.00	1.62
.095											.46	.60	.79	1.27
.100												.48	.62	1.00
.105													.49	.80
.110														.65
.115														.53
.120														.43

Refrigerant Application Summary

ASHRAE # (TRADE NAME)	COMPONENTS (WEIGHT %)	CHARGING (% ORIGINAL)	APPLICATION COMMENTS
R-22	PURE	100-105%	OVERALL CONCERNS: DISCHARGE TEMPERATURE IS IMPORTANT - CAN'T TOLERATE LARGE INCREASES. HIGHER DISCHARGE PRESSURE CAN AFFECT CONTROLS.
R-410A	32/125 (50/50)	N/A	"OVERALL CONCERNS: R-22 AVAILABILITY AND PRICE MAKE RETROFITTING A LESS ATTRACTIVE OPTION, HOWEVER IT IS POSSIBLE TO USE R-407C (POE FLUSH) OR R417A FOR RETROFITTING.

Refrigerant Properties Summary

ASHRAE # (TRADE NAME)	COMPONENTS (WEIGHT %)	TYPE	TEMP. GUIDE (F)	LUBRICANTS	COMMENTS
R-22	PURE	HCFC	0	MINERAL OIL OR ALKYL BENZENE	"NEW REFRIGERATION SYSTEMS, RETROFIT R-12 SYSTEMS INVOLVES EQUIPMENT CHANGES. STANDARD FOR A/C"
R-410A	32/125 (50/50)	HFC BLEND	0.2	POLYOLESTER	"HFC BLEND FOR NEW A/C SYSTEMS; HIGHER PRESSURES, NEW EQUIPMENT ONLY"

York Fault Code Quick Reference Chart

FAULT CODE	YORKGUARD HEAT PUMP	GAS PACK BOARD 031-01280-000	80 AND 90 AFUE STANDARD BOARD 031-01267-001 (TI)	80 AND 90 AFUE STANDARD BOARD 031-01267-001 (WR)	80 AND 90 AFUE 2 STAGE 031-01290-000	VARIABLE SPEED 031-01909-000
CONTINUOUS FLASH	NORMAL OPERATION					
RAPID FLASH	NOT USED	NOT USED		NOT USED	NOT USED	NOT USED
2 FLASHES	DISCHARGE PRESSURE REACHES 400 PSIG	COMPRESSOR LOW PRESSURE SWITCH OPEN	PRESSURE SWITCH STUCK CLOSED	PRESSURE SWITCH STUCK CLOSED	PRESSURE SWITCH STUCK CLOSED	PRESSURE SWITCH STUCK CLOSED
3 FLASHES	DISCHARGE TEMP REACHES 275	COMPRESSOR HIGH PRESSURE SWITCH OPEN	PRESSURE SWITCH STUCK OPEN	PRESSURE SWITCH STUCK OPEN	PRESSURE SWITCH STUCK OPEN	PRESSURE SWITCH STUCK OPEN
4 FLASHES	DISCHARGE TEMP DID NOT REACH 90 WITHIN ONE HOUR OF OPERATION	FLUE INDUCER CENTRIFUGAL SWITCH OPEN (FAULT) OR CLOSED (FAULT)	LIMIT OPEN	LIMIT OPEN	LIMIT OR ROLLOUT SWITCH OPEN	LIMIT OR ROLLOUT SWITCH OPEN
5 FLASHES	TWO DEFAULT DEFROSTS WITHIN ONE HOUR	ROLL OUT SWITCH OPEN	ROLLOUT SWITCH OPEN	ROLLOUT SWITCH OPEN	NOT USED	NOT USED
6 FLASHES	DISCHARGE SENSOR FAILED	FURNACE HIGH LIMIT SWITCH OPEN	PRESSURE SWITCH OPENED 4 TIMES DURING A CALL FOR HEAT	PRESSURE SWITCH OPENED 5 TIMES DURING A CALL FOR HEAT	PRESSURE SWITCH OPENED 5 TIMES DURING A CALL FOR HEAT	PRESSURE SWITCH OPENED 5 TIMES DURING A CALL FOR HEAT
7 FLASHES	OUTDOOR SENSOR FAILED	(OPTIONAL) HEATING MODE 1 HOUR WAITING PERIOD FOR AUTO RESET FROM FLAME FAILURE TO LOCKOUT	NO FLAME SENSED AT START OF CYCLE	NO FLAME SENSED AT START OF CYCLE	NO FLAME SENSED AT START OF CYCLE	NO FLAME SENSED AT START OF CYCLE
8 FLASHES	LIQUID SENSOR FAILED	NOT USED	FLAME SENSED BUT LOST 5 TIMES DURING A SINGLE CYCLE	FLAME SENSED BUT LOST 5 TIMES DURING A SINGLE CYCLE	FLAME SENSED BUT LOST 5 TIMES DURING A SINGLE CYCLE	FLAME SENSED BUT LOST 5 TIMES DURING A SINGLE CYCLE
9 FLASHES	BONNET SENSOR SHORTED	NOT USED	REVERSED LINE POLARITY	NOT USED	NOT USED	NOT USED
11 FLASHES	NOT USED	NOT USED	BROKEN ROLL OUT SENSOR OR IMPROPER GROUND	NOT USED	NOT USED	NOT USED
STEADY ON	NOT USED	BOARD FAILURE	INTERNAL FAULT	INTERNAL FAULT	INTERNAL FAULT	INTERNAL FAULT
STEADY OFF	NO POWER TO BOARD	NORMAL OPERATION	NORMAL OPERATION	NORMAL OPERATION	NORMAL OPERATION	NORMAL OPERATION

York Commercial Equipment

Simplicity Control Flash Boards

FLASH CODE	DESCRIPTION
ON STEADY	CONTROL FAILURE - REPLACE BOARD
HEART BEAT	NORMAL OPERATION
1 FLASH	N/A
2 FLASHES	CONTROL WAITING - ASCD*
3 FLASHES	HPS1 - COMPRESSOR LOCKOUT
4 FLASHES	HPS2 - COMPRESSOR LOCKOUT
5 FLASHES	LPS1 - COMPRESSOR LOCKOUT
6 FLASHES	LPS2 - COMPRESSOR LOCKOUT
7 FLASHES	FS1 - COMPRESSOR LOCKOUT
8 FLASHES	FS2 - COMPRESSOR LOCKOUT
9 FLASHES	IGNITION CONTROL LOCKED OUT; IGNITION CONTROL FAILURE; LIMIT SWITCH TRIP; NO JUMPER PLUG IN HEAT SECTION
10 FLASHES	COMPRESSORS LOCKED OUT ON LOW OUTDOOR AIR TEMPERATURE
11 FLASHES	COMPRESSORS LOCKED OUT; ECONOMIZER USING FREE COOLING
12 FLASHES	FAN OVERLOAD SWITCH TRIP
13 FLASHES	COMPRESSOR HELD OFF; LOW VOLTAGE
14 FLASHES	EEPROM STORAGE FAILURE; (CONTROL FAILURE)
OFF	NO POWER; CONTROL FAILURE

Air Conditioning Troubleshooting Guide Basic System Analysis

SYSTEM PROBLEM	DISCHARGE PRESSURE	SUCTION PRESSURE	SUPERHEAT	SUBCOOLING	AMPS
OVERCHARGE	▲	▲	▼	▲	▲
UNDERCHARGE	▼	▼	▲	▼	▼
LIQUID RESTRICTION (DRIER)	▼	▼	▲	▲	▼
LOW EVAPORATOR AIRFLOW	▼	▼	▼	▲	▼
DIRTY CONDENSER	▲	▲	▼	▼	▲
LOW OUTSIDE AMBIENT TEMPERATURE	▼	▼	▲	▲	▼
INEFFICIENT COMPRESSOR	▼	▲	▲	▲	▼
TXV FEELER BULB CHARGE LOST	▼	▼	▲	▲	▼
TXV FEELER BULB LOOSE MOUNTED	▲	▲	▼	▼	▲
POORLY INSULATED FEELER BULB	▲	▲	▼	▼	▲

General Piping Recommendations

- 1) Never add oil to the system.
- 2) Maximum total line length for the following units: Heat Pumps 1 to 5 tons 75 feet Cooling Units 1 to 1.5 tons 125 feet Cooling Units 2 to 5 tons 175 feet.
- 3) Always use a suction line accumulator when:
 - a) underground pipe exceeds 10 feet on cooling only units
 - b) piping length exceeds 75 feet on cooling only units
- 4) For split system heat pumps, size refrigerant lines to match factory supplied fittings. Vapor lines may be increased one size to minimize pressure drop. Liquid lines must NEVER be increased or decreased; the additional charge required for larger liquid lines will overflow the accumulator in the heating cycle.
- 5) Substantial differences in elevation between indoor and outdoor units will have considerable effect on line size and orifice size.
- 6) If not provided as standard, the following items are required when equivalent pipe length exceeds 50 ft.
 - a) Low voltage start kit
 - b) Off cycle timer
 - c) Crankcase heater

Additional Refrigerant Charge Required for Piping in Excess of 15 ft Total Length - R-22

FACTOR	0.44	0.46	0.48	0.66	0.68	0.7	0.76
LIQ	5/16	5/16	5/16	3/8	3/8	3/8	3/8
SUCT	3/4	3/4	7/8	5/8	3/4	7/8	1 1/8
LENGTH/FT							
16	0	0	0	1	1	1	1
17	1	1	1	1	1	1	2
18	1	1	1	2	2	2	2
19	2	2	2	3	3	3	3
20	2	2	2	3	3	4	4
21	3	3	3	4	4	4	5
22	3	3	3	5	5	5	5
23	4	4	4	5	5	6	6
24	4	4	4	6	6	6	7
25	4	5	5	7	7	7	8
26	5	5	5	7	7	8	8
27	5	6	6	8	8	8	9
28	6	6	6	9	9	9	10
29	6	6	7	9	10	10	11
30	7	7	7	10	10	11	11
31	7	7	8	11	11	11	12
32	7	8	8	11	12	12	13
33	8	8	9	12	12	13	14
34	8	9	9	13	13	13	14
35	9	9	10	13	14	14	15
36	9	10	10	14	14	15	16
37	10	10	11	15	15	15	17
38	10	11	11	15	16	16	17
39	11	11	12	16	16	17	18
40	11	12	12	17	17	18	19
41	11	12	12	17	18	18	20
42	12	12	13	18	18	19	21
43	12	13	13	18	19	20	21
44	13	13	14	19	20	20	22
45	13	14	14	20	20	21	23
46	14	14	15	20	21	22	24
47	14	15	15	21	22	22	24
48	15	15	16	22	22	23	25
49	15	16	16	22	23	24	26
50	15	16	17	23	24	25	27
51	16	17	17	24	24	25	27
52	16	17	18	24	25	26	28
53	17	17	18	25	26	27	29
54	17	18	19	26	27	27	30
55	18	18	19	26	27	28	30
56	18	19	20	27	28	29	31
57	18	19	20	28	29	29	32
58	19	20	21	28	29	30	33
59	19	20	21	29	30	31	33
60	20	21	22	30	31	32	34
61	20	21	22	30	31	32	35
62	21	22	23	31	32	33	36
63	21	22	23	32	33	34	36
64	22	23	24	32	33	34	37
65	22	23	24	33	34	35	38
66	22	23	24	34	35	36	39
67	23	24	25	34	35	36	40
68	23	24	25	35	36	37	40
69	24	25	26	36	37	38	41
70	24	25	26	36	37	39	42

FACTOR	0.44	0.46	0.48	0.66	0.68	0.7	0.76
LIQ	5/16	5/16	5/16	3/8	3/8	3/8	3/8
SUCT	3/4	3/4	7/8	5/8	3/4	7/8	1 1/8
LENGTH/FT							
71	25	26	27	37	38	39	43
72	25	26	27	38	39	40	43
73	26	27	28	38	39	41	44
74	26	27	28	39	40	41	45
75	26	28	29	40	41	42	46
76	27	28	29	40	41	43	46
77	27	29	30	41	42	43	47
78	28	29	30	42	43	44	48
79	28	29	31	42	44	45	49
80	29	30	31	43	44	46	49
81	29	30	32	44	45	46	50
82	29	31	32	44	46	47	51
83	30	31	33	45	46	48	52
84	30	32	33	46	47	48	52
85	31	32	34	46	48	49	53
86	31	33	34	47	48	50	54
87	32	33	35	48	49	50	55
88	32	34	35	48	50	51	55
89	33	34	36	49	50	52	56
90	33	35	36	50	51	53	57
91	33	35	36	50	52	53	58
92	34	35	37	51	52	54	59
93	34	36	37	51	53	55	59
94	35	36	38	52	54	55	60
95	35	37	38	53	54	56	61
96	36	37	39	53	55	57	62
97	36	38	39	54	56	57	62
98	37	38	40	55	56	58	63
99	37	39	40	55	57	59	64
100	37	39	41	56	58	60	65
101	38	40	41	57	58	60	65
102	38	40	42	57	59	61	66
103	39	40	42	58	60	62	67
104	39	41	43	59	61	62	68
105	40	41	43	59	61	63	68
106	40	42	44	60	62	64	69
107	40	42	44	61	63	64	70
108	41	43	45	61	63	65	71
109	41	43	45	62	64	66	71
110	42	44	46	63	65	67	72
111	42	44	46	63	65	67	73
112	43	45	47	64	66	68	74
113	43	45	47	65	67	69	74
114	44	46	48	65	67	69	75
115	44	46	48	66	68	70	76
116	44	46	48	67	69	71	77
117	45	47	49	67	69	71	78
118	45	47	49	68	70	72	78
119	46	48	50	69	71	73	79
120	46	48	50	69	71	74	80
121	47	49	51	70	72	74	81
122	47	49	51	71	73	75	81
123	48	50	52	71	73	76	82
124	48	50	52	72	74	76	83

Refrigerant Line Sizing Chart for Air Conditioners

UNIT CAPACITY BTUH	EQUIVALENT LENGTH OF PIPE IN FEET											
	25		35		50		75		100		125	
	125	LRA	FLA	LRA	FLA	LRA	FLA	LRA	FLA	LRA	FLA	LRA
18,000	1/4	5/8	1/4	5/8	1/4	5/8	5/16	3/4	5/16	3/4	5/16	3/4
24,000	5/16	5/8	5/16	5/8	5/16	5/8	5/16	3/4	5/16	3/4	5/16	3/4
30,000	5/16	3/4	5/16	3/4	5/16	3/4	5/16	3/4	5/16	3/4	3/8	7/8
36,000	5/16	3/4	5/16	3/4	5/16	3/4	5/16	7/8	3/8	7/8	3/8	7/8
42,000	3/8	7/8	3/8	7/8	3/8	7/8	3/8	7/8	3/8	7/8	3/8	1-1/8
48,000	3/8	7/8	3/8	7/8	3/8	7/8	3/8	7/8	3/8	1-1/8	3/8	1-1/8
60,000	3/8	7/8	3/8	7/8	3/8	7/8	3/8	1-1/8	1/2	1-1/8	1/2	1-1/8
72,000	1/2	1-1/8	1/2	1-1/8	1/2	1-1/8	1/2	1-1/8	1/2	1-1/8	1/2	1-1/8
90,000	1/2	1-1/8	1/2	1-1/8	1/2	1-1/8	1/2	1-1/8	1/2	1-3/8	1/2	1-3/8
120,000	1/2	1-1/8	1/2	1-3/8	5/8	1-3/8	5/8	1-3/8	5/8	1-3/8	5/8	1-3/8
150,000	5/8	1-3/8	5/8	1-3/8	5/8	1-3/8	5/8	1-5/8	5/8	1-5/8	5/8	1-5/8
180,000	5/8	1-5/8	5/8	1-5/8	5/8	1-5/8	5/8	1-5/8	3/4	1-5/8	3/4	1-5/8
240,000	3/4	1-5/8	3/4	1-5/8	3/4	2-1/8	3/4	2-1/8	3/4	2-1/8	3/4	2-1/8
300,000	7/8	1-5/8	7/8	2-1/8	7/8	2-1/8	7/8	2-1/8	7/8	2-1/8	7/8	2-1/8
360,000	7/8	2-1/8	7/8	2-1/8	7/8	2-1/8	7/8	2-1/8	7/8	2-1/8	7/8	2-1/8

TABLE OF CONTENTS

ALPHABETIZED LISTING

A				
Accu-Link, Adjustable V-Belts	136	Carbon Dioxide Sensor	88	Scroll Compressors
Acid Test Kit	155	Cartridge Fuses	153	ZR16K thru ZR300K Series
Actuators, Damper		Non-Renewable	153	CR5 Series Compressors (Copeland)
Direct Mount Accessories		Central Dehumidifiers	85	CR6 Series Compressors (Copeland)
Valve Linkages	97	Century Electric		Crankcase Heaters
Electric, Spring-Return	96-97	Motors		For Copeland Compressors
Adapter		Capacitor Start, Resilient Base Motors	108	CRKQ Series Compressors (Copeland)
Fuses	153	Condenser Fan Motors	108	Cross Reference
Add-A-Wire Accessory		Continuous Duty, Air Over, Vertical	108	ICM HVACR Controls
for All Conventional Thermostats	14, 15	Three-Phase, Outdoor, Ball Bearing Motors		Condensation Control/Alarm
Air Cleaners		O.E.M. Direct Replacement Motors	109	Delay on Break Timers
Electronic	81	Check Valves	26	Delay on Make Timers
Expandable Media	82	Circuit Breakers		Duty Cycle Controls
Upgrade Kits	83	Homeline		Fan Blower Controls
Hybrid Media/Electronic	81	Double Pole, 120/240 VAC	151	Fan Coil Relay Control Boards
Right Angle Media	82	Single Pole, 120/240 VAC	151	Fan Safety Alarm
Air Conditioning & Refrigeration Controls	19	QO Style		Furnace Control Boards
Air Cub® Replacement Media	83	Double Pole, 120/240 VAC	151	Gas Ignition Controls
AMP Extraction Tools	155-156	Cobra Blade Propellers		Head Pressure Controls
Apollo America, Inc.		3-Blade Propellers	121	Impedance/Lockout Relay
Duct Smoke Detectors	86, 87	4-Blade Propellers	121	Line Monitors
Sampling Tube	86	Coil, Solenoid (Unloading)	8	Motor Starter/Rapid Start
Power Supplies	87	Comfort Control Center	61	Oil Burner Primary Control
Aquastat Controller Relay	53	Commercial Accessory Thermostats	13	Surge Protection
Aquastat Controllers	53-54	Compressors		Universal Motor Starting Relays
B		Copeland Compressors	1-11	Replacement Compressors
Ball Bearings	128-129	Nomenclature Guide		Danfoss to Trane
Bearings	128-129	CR7, CR6, CRKF, CS, CF Models	3	LG Scrolls to Copeland
Sleeve		CRKQ & CIKQ Models	2	Current Sensing Hard Starts
Cartridge	128	Reciprocating Compressors	4-6	57
Pillow Block	128	CR5 Series Compressors	4	D
Belt Drive Blower Assemblies	123	CR6 Series Compressors	4	Dampers
Belt Drive Double Inlet Blower Assemblies	126	CRKQ Series Compressors	5	Barometric By-Pass
Bi-Flow Filter Driers	21	ZP Series (for R410A)	6	Rectangular
Blower Assemblies	123-126	Scroll Compressors	1, 7-9	Round
Belt Drive Blowers	123	ZR Series Compressors	7-8	Rectangular Zoning
Direct Drive Blowers	123	LG Electronics		Bottom Mount
Double Inlet		Scroll	11	Side Mount
Aluminum w/ Steel Hubs	124	Compressor Sound Blankets		Danfoss
Belt Drive	126	Brinmar	12	Expansion Valve Kits, Universal
Direct Drive	125-126	Premier	9	Dead End, Fully Insulated Wire Connectors
Blower Motors	100	Scott Manufacturing, "Acousticap"	9, 12	151
Direct Drive ECM	109	Condensation Overflow Controls	56	Defrost Timers
Single Horsepower	100	Condenser Covers	147	Delay On Break Timers
Blower Shafts	127	Innerflow™	147	66
Blower Wheels		Condenser Fan Motors		Delays
Double Inlet, Single Hub		Blower Motors	108	Adjustable
Concave Center Plate	116	Continuous Duty, Air Over, Vertical	108	Fixed Time
Convex Center Plate	116	High-Ambient	99	Direct Drive Blower Assemblies
BOSS Products		MULTIFIT®	108	Double Inlet
125 Multi-Seal Building Construction Sealant	148	Three-Phase, Outdoor, Ball Bearing Motors	109	125-126
Brackets, Mounting		Condensing Furnace Vent Terminal Kits		Direct Drive PSC Blower Motors
"Belly" Band Adapter	130	Concentric	146	103-107
Direct Drive Motor	130	Horizontal	147	Direct Ignition/Dual Auto Gas Valves
Motor Mounting Hardware Kit	127	Conduit		30
Brinmar		Connectors		Direct Mount Actuator Accessories
Compressor Sound Blankets	12	BX Set Screw	151	Valve Linkages
Bushing		Contactors	55	97
Mall Iron	135	Definite Purpose	55	Direct Spark, Non-Integrated Ignition Module
Buss Fuses		Control Module and Terminal Board	8	39
Dual Element Time Delay		Control Panels, Zoning		Discharge Air Zoning Sensor
250 Volt, Class RK5	152	Accessories		89
600 Volt, Class RK5	152	Discharge Air Zoning Sensor	89	Disconnects
Supplemental	152	Outside Air Sensor	90	Metal with Door
Time Delay		Static Pressure Zoning Control	89	150-152
480 V	153	Static Pressure Zoning Switch	89	Disconnect Terminals
Bypass Humidifiers	84	Four-Zone	89	Fully Insulated
Bypass Timers	65	Three-Zone, Multi-Stage	89	Female
C		Three-Zone, Single Stage	89	150
Capacitors		Two-Zone Add-On Module	89	150-152
Dual Run	115	Controls		Fully Insulated
Diversitech	115	Motor Speed	111-112	Female
SOURCE 1	114	ECM Controllers	111-112	Insulated
Selection Guide for FHM Motors	102	Controls Enclosure	72	Female
Single Run		Copeland Compressors		Special Purpose
SOURCE 1	113	Accessories		150
Start	115	Capacitors, Start, High Torque	10	Fuses
Start, High Torque	10	Capacity Control Valve with Gasket	8	Adapters
Turbo® 200	115	Coil, Solenoid (Unloading)	8	Blade (Auto)
Capacitor Start, Resilient Base Motors	108	Compressor Sound Blankets	9	152
Capacity Control Valve w/ Gasket	8	Premier Compressor Blankets	9	Motor Mounting Brackets
Carbide and Nitride Ignition Module		Scott Manufacturing Compressor Blankets	9	Flex Bracket - 3 Leg
Multi-Stage	47	Control Module and Terminal Board	8	Lug Assembly
Single Stage	39	Crankcase Heaters	9	129
		Roto-Lock Adapters	10	Slip-On Terminals
		Terminal Parts Kit, Compressors	9	149-151
		Nomenclature Guide	1-3	Combination Pack
		CR7, CR6, CRKF, CS, CF Models	3	Fully Insulated
		CRKQ, CIKQ Models	2	Female
		Scroll Compressors	1	149
		Reciprocating Compressors	4-6	Insulated
		CR5 Series Compressors	4	Female
				149
				Spade Terminals
				Insulated
				149
				Tab Adapter Terminals
				Piggy Back Slip-Ons
				Single Female Double Male Tabs
				149
				Wire Connectors
				150

TABLE OF CONTENTS ALPHABETIZED LISTING

<i>Dead End, Fully Insulated</i>	151	<i>Goodman Replacement</i>	41	<i>Twin Pipe to Concentric Adapter</i>	145
Double Groove Sheaves	130-135	<i>Lennox Replacement</i>	42	<i>Vertical Concentric Termination</i>	144
Draft Inducers	111	<i>Nordyne Replacement</i>	43	Head Pressure Ctrls & Accs	71
Dual Element Time Delay Buss Fuses		<i>Rheem Replacement</i>	41, 43, 44	<i>Pressure Transducer</i>	72
250 Volt, Class RK5	152	<i>YORK/EVCON Replacement</i>	42	<i>Probe</i>	72
600 Volt, Class RK5	152	<i>YORK Replacement</i>	43	Heat Pump Defrost Control Board	58
Dual Run Capacitors		Furnace Control Modules	40-42	Heat Recovery Ventilator	85
Diversitech	115	<i>ICM Controls, Inc.</i>		Heat Sequencers, Electric	50
SOURCE 1	114	<i>Carrier Replacements</i>	40	High-Ambient Condenser Fan Motors	99
Duct Smoke Detectors	86, 87	<i>Continuous Retry</i>	42	Homeline Circuit Breakers	
Sampling Tube	86, 87	<i>Furnace Fan Blower Control</i>	40-42	<i>Double Pole, 120/240 VAC</i>	151
Duty Cycle Timer Delays	67	<i>Goodman Replacement</i>	41	<i>Single Pole, 120/240 VAC</i>	151
E		Fuses	152-154	Honeywell	
East West Manufacturing		<i>Adapters</i>	153	<i>Carbon Dioxide Sensor</i>	88
Condensing Furnace Vent Terminal Kits		<i>Blade (Auto)</i>	152	<i>Control, Gas Ignition</i>	
<i>Concentric</i>	146	<i>Cartridge</i>		<i>Intermittent Pilot</i>	36
<i>Horizontal</i>	147	<i>Non-Renewable</i>	153	<i>Gas Valves</i>	
ECM Controllers	111, 112	G		<i>Continuous Pilot/Dual Auto Combination</i>	29
ECM Direct Drive Blower Motor	109	Gas Heating Controls	27-49	<i>Direct Ignition/Dual Auto</i>	30
Electric Heat Sequencers	50	Gas Valves	27-32	<i>Electronic Ignition, Universal</i>	31
Electric, Spring-Return Actuators	96-97	<i>Gas Valve Conversion Kits</i>	27	<i>Intermittent Pilot/Dual Auto</i>	30
Electronic Air Cleaners	81	<i>Honeywell</i>		<i>Ignition Module</i>	
Hybrid Media/Electronic	81	<i>Continuous Pilot/Dual Auto Combination</i>	29	<i>Hot Surface, Universal</i>	37
Electronic Ignition, Universal Gas Valve	31	<i>Direct Ignition/Dual Auto</i>	30	<i>Intermittent Pilot</i>	36
Emerson Climate Technologies		<i>Electronic Ignition, Universal</i>	31	<i>Integrated Furnace Control</i>	
80 Series™ Thermostats	17	<i>Intermittent Pilot/Dual Auto</i>	30	<i>Hot Surface Ignition</i>	37
Coil, Solenoid (Unloading)	8	<i>SmartValve® System Controls</i>	31	<i>Intermittent Pilot Retrofit Kit</i>	40
Control Module (Motor Protector) and Terminal Board	8	<i>V800 Standing Pilot</i>	29	<i>Oil Burner Control, Protectorelay®</i>	52
Emerson Blue™		<i>White Rodgers</i>		<i>Pilot Burners</i>	
<i>2-Inch Thermostats</i>	16	<i>High Capacity, 36H Series</i>	27	<i>for Main Burner Ignition</i>	32
<i>6-Inch Thermostats</i>	17	<i>Replacement, 36C Series</i>	28	<i>for Natural Gas</i>	32
<i>Indoor Temperature Sensor</i>	15	<i>Universal, 36J Series</i>	28	<i>Signal Interface Module</i>	98
<i>Outdoor Temperature Sensor</i>	15	Gas Water Heater		<i>Thermocouples</i>	32-33
<i>Universal Touchscreen Thermostats</i>	15	<i>Valves</i>	54	<i>Transformers</i>	78-80
Emerson SureSwitch Relay	61	Genteq		<i>Standard</i>	78
Temperature Sensors	15	<i>Motors</i>		<i>Zone Valves</i>	54
Terminal Parts Kit, Compressors	9	<i>Direct Drive Blower Motor</i>		Honeywell Gas Valves	29-32
Enclosed Fan Relay	61	<i>ECM</i>	109	Hot Surface Ignition Controls	37, 48-50
Energy Recovery Ventilators	85	GE Tecamate Pro™ Motor Tester	155	<i>Integrated Furnace Control</i>	37
Equipment Paint Guide	161	Gexpro		<i>Source 1</i>	34
Expandable Media Air Cleaners	82	<i>Buss Fuses</i>		<i>Silicon Carbide Igniters</i>	37
Expansion Valve Kits, Universal	23	<i>Dual Element Time Delay</i>		<i>Universal Module</i>	
Expansion Valves		<i>250 Volt, Class RK5</i>	152	<i>White Rodgers</i>	
Sporlan O, S, EBSVE, ERZE, RC Series	24	<i>600 Volt, Class RK5</i>	152	<i>Carrier, Single Stage</i>	48
Expansion Valves, Thermostatic	23-25	<i>Supplemental</i>	152	<i>Trane, 80V Single Stage</i>	48
		<i>Time Delay</i>		<i>Trane, 120V Single Stage</i>	48
		<i>480 V</i>	153	<i>York, Single Stage</i>	48
		Fuses		Hub Pullers	122
		<i>Cartridge</i>	153	Hubs, Interchangeable	122
		<i>Non-Renewable</i>	153	Humidifiers	
		H		<i>Bypass</i>	84
Fan Blower Control	69-70	Hard Start Devices		<i>Flow-Through</i>	84
Fan Coil Relay Control	63-64	<i>3-in-1 Hardstarts</i>	57	<i>Replacement Water Pads</i>	84
Fan Control Center	70	<i>Current Sensing Hardstarts</i>	57	<i>Steam</i>	84
Fan Delay Timer, Post-Purge	68	<i>Hard Start Kit</i>	58	I	
Fan & Limit Controls	51	<i>PTCR Hardstart Capacitors</i>	57	ICM Controls, Inc.	
Adjustable	51	<i>Voltage Sensing</i>	58	<i>Comfort Control Center</i>	61
Fan Controls	51	Hart and Cooley, Inc.		<i>Condensation Overflow Controls</i>	56
Manual Reset	52	Polyflue		<i>Controls Enclosure</i>	72
SPDT	51	<i>Polypropylene Venting System</i>	143-146	<i>Delays</i>	
SPST	52	<i>45° Elbow</i>	144	<i>Adjustable</i>	65
Fan Safety Alarm Circuit Control	68	<i>90° Elbow</i>	143	<i>Delay on Break Timers</i>	66-67
FASCO Motors	110, 111	<i>Bird Screen</i>	145	<i>Duty Cycle Timers</i>	67
Draft Inducers	111	<i>B-Vent Re-line Storm Collar</i>	145	<i>Fan Delay, Post-Purge</i>	68
Motor Mounting Brackets		<i>Condensate Drain Tube</i>	144	<i>Fixed Time</i>	64
<i>A.O. Smith Fleximount Adapter</i>	130	<i>EZ Seal to Poly Adapter</i>	145	<i>Random Start Timers</i>	67
<i>Flex Bracket - 4 Leg</i>	129	<i>Firestop, Wall Plate</i>	145	<i>Fan Blower Control</i>	69-70
OEM Replacement Motors	110	<i>Flex Kit</i>	145	<i>Fan Coil Relay Control</i>	63-64
PSC, 3-in-1, 3.3"	110	<i>Flex Pipe Roll</i>	145	<i>Fan Safety Alarm Circuit Control</i>	68
Unit Bearing Motors	110	<i>Flex Spacer</i>	145	<i>Freeze Protection Modules</i>	59
Filter Cores (Replaceable)	21	<i>Gaskets - Straight Pipe/Flex Pipe</i>	146	<i>Defrost Timers</i>	59
Filter Driers	19-22	<i>Horizontal Concentric Termination</i>	144, 144-147	Furnace Control Board	
Bi-Flow	21	<i>Horizontal Support</i>	146	<i>Carrier Replacement</i>	44, 45
Liquid Line	20	<i>Increase</i>	144	<i>Goodman Replacement</i>	41
Liquid Line (Solid Core)	19	<i>Inline Condensate Drain</i>	144	<i>Lennox Replacement</i>	42
Replaceable Core	21	<i>Locking Band</i>	146	<i>Nordyne Replacement</i>	43
Reversible Heat Pump	22	<i>Nominal to Poly Adapter</i>	145	<i>Rheem Replacement</i>	41, 43, 44
Suction Line	22	<i>Poly to EZ Seal Adapter</i>	146	<i>YORK/EVCON Replacement</i>	42
Suction Line, Compact	22	<i>PVC to Poly Adapter</i>	145	<i>YORK Replacement</i>	43
Fixed Time Delays	64	<i>Reducer</i>	144	Furnace Control Modules	
Flame Sensors	36, 37	<i>Rigid Pipe, Single Wall</i>	143	<i>Carrier Replacement</i>	40
Flow-Through Humidifiers	84	<i>Roof Flashings - Aluminum</i>	146	<i>Continuous Retry</i>	111, 42
Fractional Horsepower Motors	99-107	<i>Roof Flashings - Galvalume® Flashings</i>	146	<i>Furnace Fan Blower Control</i>	40-42
Fractional Horsepower V-Belts	139	<i>Roof Flashings - Thermoplastic</i>	146	<i>Goodman Replacement</i>	41
Freeze Protection Modules	59	<i>Sealant</i>	146	Hard Start Devices	
Defrost Timers	59	<i>Tee</i>	144	<i>3-in-1 Hardstarts</i>	57
Furnace Control Board		<i>Tee Cap</i>	144	<i>Current Sensing</i>	57
ICM Controls, Inc.		<i>Tee Cap with Drain</i>	144	<i>PTCR Hardstart Capacitors</i>	57
<i>Carrier Replacement</i>	44	<i>Test Port</i>	144	<i>Head Pressure Controls</i>	71
				<i>Head Pressure Ctrls & Accs</i>	
				<i>Pressure Transducer</i>	72
				<i>Probe</i>	72

TABLE OF CONTENTS

ALPHABETIZED LISTING

Ignition Control Board <i>Spark Ignition Control, Carrier</i>	45	4-Blade Propellers	121	B-Vent Re-line Storm Collar	145
Intermittent Pilot Ignition Control <i>Carrier Replacement</i>	45	Shafts, Blower	127	Condensate Drain Tube	144
<i>Lennox Replacement</i>	46	Thrust Collar Kit	127	EZ Seal to Poly Adapter	145
<i>YORK Replacement</i>	45, 46, 58	Thrust Spacer Kit	127	Firestop, Wall Plate	145
Line Monitors	74-80	Vibration Pads	127	Flex Kit	145
Lockout Protection Relays	56	LG Electronics		Flex Pipe Roll	145
Motor Protection	60-61	Compressors	10-11, 11	Flex Spacer	145
Relays, Motor Starting	60	<i>Scroll</i>	10-11, 11	Gaskets - Elbows & Tees	146
Temporary Construction Thermostats	18	Line Monitors	74-80	Horizontal Concentric Termination	144
Timers, Bypass	65	Locking Ring/Wall Plate		Horizontal Support	146
Igniters	34-36	for LX Series Thermostats	14	Increases	144
Ignition Control Board		for THE Series Thermostats	15	Inline Condensate Drain	144
ICM Controls, Inc.		Lockout Protection Relays	56	Locking Band	146
<i>Spark Ignition Control, Carrier</i>	45	M		Nominal to Poly Adapter	145
Ignition Module				Poly to EZ Seal Adapter	146
Direct Spark, Non-Integrated	39	Modulating Round Zoning Dampers	90	PVC to Poly Adapter	145
Hot Surface, Universal	37	Modutrol IV Motors	98	Reducer	144
Intermittent Pilot	36	Morrison Products		Rigid Pipe, Single Wall	143
Intermittent Pilot, Non-Integrated	39	Blower Wheels		Roof Flashings - Aluminum	146
Non-Integrated HSI Systems	38	<i>Double Inlet, Single Hub</i>		Roof Flashings - Galvalume® Flashings	146
Silicon-Carbide, Integrated	38	<i>Convex Center Plate</i>	116	Roof Flashings - Thermoplastic	146
Silicon Carbide, Non-Integrated	38	Motor Mounting Hardware Kit	127	Sealant	146
Single Stage, Carbide and Nitride	39	Motor Protection	60-61	Tea	144
White Rodgers		Motors	99-114	Tea Cap	144
<i>Multi-Stage, Carbide and Nitride</i>	47	Blower Motors		Tea Cap with Drain	144
Ignition Modules & Furnace Controls	36-48	<i>Direct Drive ECM</i>	109	Test Port	144
Indoor/Outdoor Temp Sensor		<i>PSC, Direct Drive</i>	103-107	Twin Pipe to Concentric Adapter	145
for CTS Thermostats	13	<i>Single Horsepower</i>	100	Vertical Concentric Termination	144
Indoor Temperature Sensor		Capacitor Start, Resilient Base Motors	108	Polypropylene Venting System	143-146
for Emerson Blue™ Thermostats	15	Condenser Fan Motors	99, 108	Post-Purge Fan Delay Timer	68
for LX Series Thermostats	14	<i>Continuous Duty, Air Over, Vertical</i>	108	Power Generator	
Innerflow™ Condenser Covers	147	<i>High-Ambient</i>	99	White Rodgers	
Integrated Furnace Control		<i>PSC, Timesaver, Multi-Horsepower</i>	101	750 Millivolt	33
Hot Surface Ignition	37	<i>Single Horsepower</i>	100	Power Supplies	87
Intermittent Pilot		<i>Three-Phase, Outdoor, Ball Bearing Motors</i>	108	Pressure Transducer	72
Dual Auto Gas Valves	30	Fractional Horsepower Motors	99-107	Propeller Fans	116-121
Ignition Control		O.E.M. Direct Replacement Motors	109	2-Blade Propellers	
ICM Controls, Inc.		<i>Century Electric</i>	109	<i>OEM Style, Fixed Hub</i>	117
<i>YORK Replacement</i>	45, 46, 58	PSC Motors		3-Blade Propellers	
Non-Integrated Ignition Module	39	<i>Timesaver, Multi-Horsepower</i>	101	<i>Heavy Duty Condenser Style</i>	117-118
Retrofit Kit	40	Motor Speed Controls	111-112	4-Blade Propellers	119-120
Intermittent Pilot Ignition Control		ECM Controllers	111-112	<i>Heavy Duty Condenser Style</i>	
ICM Controls, Inc.		Motor Starting Relays, Universal	60	Cobra Blade Propellers	
<i>Carrier Replacement</i>	45	Motor Tester		3-Blade Propellers	121
J		GE Tecamate Pro™	155	4-Blade Propellers	121
Johnson Controls, Inc.		Mounting Brackets		Protectorelay®	52
Actuators		A.O. Smith Fleximount Adapter	130	Oil Burner Control	52
<i>Direct Mount Accessories</i>		Direct Drive Motor	130	PSC Motors	
<i>Valve Linkages</i>	97	Flex Bracket - 3 Leg	129	Blower	
<i>Electric, Spring-Return</i>	96-97	Flex Bracket - 4 Leg	129	3-in-1, 3.3" FASCO Motors	110
K		Lug Assembly	129	Direct Drive	103-107
Koch Filters		Multi-Cogged V-Belts	139-141, 140-142	<i>Timesaver, Multi-Horsepower</i>	101
Replacement Media		Multi-Plus V-Belts	136-138	Condenser	
<i>Honeywell® F-Series</i>	83	N		<i>Timesaver, Multi-Horsepower</i>	101
<i>Trion Airbear® and Air Cub®</i>	83	Nomenclature Guide		QO Style Circuit Breakers	
L		Copeland A/C Scroll Compressors	1	Double Pole, 120/240 VAC	151
Lau Industries		Copeland CR7, CR6, CRK6, CS, CF	3	R	
Bearings	128-129	Copeland CRKQ, KIKQ Compressors	2	Random Start Timer	67
Ball	128	<i>CRKQ, CIKQ Models</i>	2	RapidStart® Hardstart	57
Sleeve		O		Refrigeration Ball Valves	27
Cartridge	128	O.E.M. Direct Replacement Motors		Sporlan, EBV & EBVT Series	27
Pillow Block	128	Century Electric	109	Regal Beloit	
Blower Assemblies	123-126	FASCO Motors	110	Motor Tester	
Belt Drive Blowers	123, 126	Oil Burner Control, Protectorelay®	52	GE Tecamate Pro™	155
Direct Drive Blowers	123	Outdoor Temperature Sensor		Relay	
Double Inlet		for LX Series Thermostats	14	Aquastat Controller	53-54
Aluminum w/ Steel Hubs	124	Outside Air Sensor	90	Control, Fan Coil	63-64
Direct Drive	125-126	Overflow Controls, Condensation	56	Fan, Enclosed	61
Blower Wheels		P		Lockout Protection	56
<i>Double Inlet, Single Hub</i>		Paint Guide	161	Motor Starting	60
<i>Concave Center Plate</i>	116	Paints & Primers	148	Replaceable Core Filter Driers	21
Brackets, Mounting		Touch-up Paints		Replacement Media	82
"Belly" Band Adapter	130	Pillow Blocks		for Electronic/Hybrid Air Cleaners	81
Direct Drive Motor	130	Sleeve Bearings	128	for Expandable Media Air Cleaners	82
Motor Mounting Hardware Kit	127	Pilot Burners		for Honeywell Air Cleaners	83
Hub Pullers	122	for Main Burner Ignition	32	for Honeywell® F-Series	83
Hubs, Interchangeable	122	for Natural Gas	32	for Right Angle Media Air Cleaners	82
Pitch Gauge	122	Pitch Gauge	122	for Trion Airbear® and Air Cub®	83
Propeller Fans	116	Polyflue		Replacement Thermocouples, Universal	33
2-Blade Propellers		Polypropylene Venting System	143-146	Residential Accessory Thermostats	13
<i>OEM Style, Fixed Hub</i>	117	45° Elbow	144	THE Series Thermostats	14
3-Blade Propellers		90° Elbow	143	Residential Air Filtration Systems	81-84
<i>Heavy Duty Condenser Style</i>	117-118	Bird Screen	145	Retro Round Zoning Dampers	90
4-Blade Propellers				Reversible Heat Pump Filter Driers	22
<i>Heavy Duty Condenser Style</i>	119-120			Right Angle Media Air Cleaners	82
Cobra Blade Propellers				Rigid Pipe, Single Wall	143
3-Blade Propellers	121			Rotolock Adapter Kits	10

TABLE OF CONTENTS

ALPHABETIZED LISTING

Multi-Cogged	139–141, 140–142	Conversion Kits	27	Blue™, 4-Inch & 6-Inch Thermostats	17
Multi-Plus	136–138	High Capacity, 36H Series	27	Emerson Blue	
Narrow, Cogged, Raw Edge, Deep Wedge	138–139	Replacement, 36C Series	28	Universal Touchscreen	15
Venting System, Polypropylene	143–146	Universal, 36J Series	28	Transformers	
Vibration Pads	127	Heat Sequencers, Electric	50	Multi-Mount/Foot-Mount	79
W		Hot Surface Ignition Controls	48–50	Valves	
Wall Plate, Thermostat		Carrier, Single Stage	48	Gas Water Heater	54
for CTS Thermostats	13	Trane, 80V Single Stage	48	Wire Connectors	151–153
for LX Series Thermostats	14	Trane, 120V Single Stage	48	Dead End, Fully Insulated	151
for THE Series Thermostats	15	York, Single Stage	48	Wireless Temp and Pressure Sensors	155
Water Heater Valves, Gas	54	Ignition Module			
Water Pads for Humidifiers	84	Direct Spark, Non-Integrated	39	Z	
Weatherproof Enclosure		Intermittent Pilot, Non-Integrated	39	Zone Valves	
Controls	72	Multi-Stage, Carbide and Nitride	47	Honeywell	54
White Rodgers		Non-Integrated HSI Systems	38	Zoning Control Panels	88, 89
Defrost Control, Heat Pump	58	Silicon-Carbide, Integrated	38	Zoning Dampers	90–93
Fan & Limit Controls, Snap Disc		Silicon-Carbide, Non-Integrated	38	Barometric By-Pass	
Fan Controls	51	Single Stage, Carbide and Nitride	39	Rectangular	94
Manual Reset	52	Power Generator		Round	94
SPDT	51	750 Millivolt	33	Modulating, Round	90
SPST	52	Relay, Switch	61	Rectangular, Bottom Mount	91–92
Fan & Limit Controls, Universal	49–50	Thermocouples		Rectangular, Side Mount	92–94
Flame Sensors	37	Universal Replacement	33	Retro Round	90
Gas Valves		Thermostat Accessories		Zoning Sensor, Discharge Air	89
		Indoor Temperature Sensor	15	Zoning Switch, Static Pressure	89
		Outdoor Temperature Sensor	15		
		Thermostats			
		Emerson			
		Blue™, 2-Inch Thermostats	16		

TABLE OF CONTENTS

PART NUMBER INDEX

S1 PART NO	PAGE	S1 PART NO	PAGE	S1 PART NO	PAGE	S1 PART NO	PAGE	S1 PART NO	PAGE
S1-02619368000	116	S1-02817110000	131	S1-A88	137	S1-AX73	140	S1-B96	138
S1-02619369000	116	S1-02924422000	129	S1-A89	137	S1-AX75	140	S1-B97	138
S1-02619370000	116	S1-02924423000	129	S1-A90	137	S1-AX76	140	S1-B100	138
S1-02619372000	116	S1-51301503000	148	S1-A91	137	S1-AX78	140	S1-B101	138
S1-02619654012	116	S1-51301505000	148	S1-A92	137	S1-AX80	140	S1-B103	138
S1-02619654014	116	S1-51301530000	148	S1-A93	137	S1-AX84	140	S1-B108	138
S1-02642203000	155	S1-51301531000	148	S1-A94	137	S1-AX85	140	S1-B116	138
S1-02804255700	130	S1-51302881700	148	S1-A95	137	S1-AX86	140	S1-B120	138
S1-02804761700	134	S1-51302934000	148	S1-A96	137	S1-AX90	140	S1-B124	138
S1-02804762700	134	S1-52118452000	155	S1-A97	137	S1-AX92	140	S1-B133	138
S1-02804763700	134	S1-52118453000	155	S1-A98	137	S1-AX96	140	S1-B136	138
S1-02804764700	135	S1-52118454000	155	S1-ABG034KAC	11	S1-B21	137	S1-B144	138
S1-02804765700	134	S1-52118456000	155	S1-ABG036KAC	11	S1-B22	137	S1-B150	138
S1-02804807700	134	S1-52636217000	20	S1-ABG039KAC	11	S1-B23	137	S1-B158	138
S1-02804807700	135	S1-A15	136	S1-ABG042KAC	11	S1-B24	137	S1-B162	138
S1-02804869700	131	S1-A16	136	S1-ABG049KAC	11	S1-B25	137	S1-B210LP	86
S1-02805419700	132	S1-A17	136	S1-ABG051KAC	11	S1-B26	137	S1-BFD083S	21
S1-02805447700	134	S1-A18	136	S1-ACC-OE-03	72	S1-B27	137	S1-BFD163S	21
S1-02806405700	134	S1-A19	136	S1-ACD30	150	S1-B28	137	S1-B-LINK-5	136
S1-02806434700	134	S1-A20	136	S1-ACD60	150	S1-B29	137	S1-B-LINK-6	136
S1-02806564700	135	S1-A21	136	S1-ACD60NF	150	S1-B30	137	S1-BOSS12503	148
S1-02807216700	131	S1-A22	136	S1-ACH55	56	S1-B31	137	S1-BP4000MT	84
S1-02807229700	134	S1-A23	136	S1-ACS-8	76	S1-B32	137	S1-BP5000MT	84
S1-02808158700	131	S1-A24	136	S1-ACS-11	76	S1-B33	137	S1-BP6000MT	84
S1-02808255700	131	S1-A25	136	S1-ADDWIRE	14	S1-B34	137	S1-BX30	140
S1-02808256700	131	S1-A26	136	S1-ADDWIRE	15	S1-B35	137	S1-BX31	140
S1-02808257700	131	S1-A27	136	S1-A-LINK-5	136	S1-B36	137	S1-BX32	140
S1-02808346000	132	S1-A28	136	S1-A-LINK-25	136	S1-B37	137	S1-BX33	140
S1-02808525900	132	S1-A29	136	S1-AOS	86	S1-B38	137	S1-BX34	140
S1-02808617700	135	S1-A30	136	S1-APA151	86	S1-B39	137	S1-BX35	140
S1-02808736700	133	S1-A31	136	S1-APG016KAC	11	S1-B40	137	S1-BX36	140
S1-02808757700	134	S1-A32	136	S1-APG020KAC	11	S1-B41	137	S1-BX37	140
S1-02808769700	133	S1-A33	136	S1-APG025KAC	11	S1-B42	137	S1-BX38	140
S1-02808828700	134	S1-A34	136	S1-APG029KAC	11	S1-B43	137	S1-BX39	140
S1-02809570700	131	S1-A35	136	S1-APG031KAC	11	S1-B44	137	S1-BX40	140
S1-02809985700	131	S1-A36	136	S1-ATT2D1683	78	S1-B45	137	S1-BX41	140
S1-02809992700	132	S1-A37	136	S1-AX22	139	S1-B46	137	S1-BX42	140
S1-02809993700	134	S1-A38	136	S1-AX23	139	S1-B47	137	S1-BX43	140
S1-02810436701	134	S1-A39	136	S1-AX24	139	S1-B48	137	S1-BX44	140
S1-02810564700	131	S1-A40	136	S1-AX25	139	S1-B49	137	S1-BX45	140
S1-02810577700	131	S1-A41	136	S1-AX26	139	S1-B50	137	S1-BX46	140
S1-02810855700	134	S1-A42	136	S1-AX27	139	S1-B51	137	S1-BX47	140
S1-02812010700	134	S1-A43	136	S1-AX28	139	S1-B52	137	S1-BX48	140
S1-02812012700	131	S1-A44	136	S1-AX29	139	S1-B53	137	S1-BX49	140
S1-02812026700	131	S1-A45	136	S1-AX30	139	S1-B54	137	S1-BX50	140
S1-02812061700	133	S1-A46	136	S1-AX31	139	S1-B55	137	S1-BX51	140
S1-02812064700	135	S1-A47	136	S1-AX32	139	S1-B56	137	S1-BX52	140
S1-02812070700	133	S1-A48	136	S1-AX33	139	S1-B57	137	S1-BX53	140
S1-02812082700	135	S1-A49	136	S1-AX34	139	S1-B58	137	S1-BX54	140
S1-02812306700	135	S1-A50	136	S1-AX35	139	S1-B59	137	S1-BX55	140
S1-02812307700	133	S1-A51	136	S1-AX36	139	S1-B60	137	S1-BX56	140
S1-02812308700	133	S1-A52	136	S1-AX37	139	S1-B61	137	S1-BX57	140
S1-02812338700	135	S1-A53	136	S1-AX38	139	S1-B62	137	S1-BX58	140
S1-02812361700	135	S1-A54	136	S1-AX39	139	S1-B63	137	S1-BX59	140
S1-02812363700	131	S1-A55	136	S1-AX40	139	S1-B63	138	S1-BX60	140
S1-02812364700	131	S1-A56	136	S1-AX41	139	S1-B64	138	S1-BX61	140
S1-02812365700	134	S1-A57	136	S1-AX42	139	S1-B65	138	S1-BX62	140
S1-02812368700	132	S1-A58	136	S1-AX43	139	S1-B66	138	S1-BX63	140
S1-02812369700	130	S1-A59	136	S1-AX44	139	S1-B67	138	S1-BX64	140
S1-02812374700	135	S1-A60	136	S1-AX45	139	S1-B68	138	S1-BX65	140
S1-02812383700	131	S1-A61	136	S1-AX46	139	S1-B69	138	S1-BX66	140
S1-02812384700	131	S1-A62	136	S1-AX47	139	S1-B70	138	S1-BX67	140
S1-02812385700	135	S1-A63	136	S1-AX48	139	S1-B71	138	S1-BX68	140
S1-02812388700	131	S1-A64	136	S1-AX49	139	S1-B72	138	S1-BX69	140
S1-02812403700	134	S1-A65	136	S1-AX50	139	S1-B73	138	S1-BX70	140
S1-02812765700	131	S1-A66	136	S1-AX51	139	S1-B74	138	S1-BX71	140
S1-02812767700	131	S1-A67	136	S1-AX52	139	S1-B75	138	S1-BX72	140
S1-02812773700	132	S1-A68	136	S1-AX53	139	S1-B76	138	S1-BX73	140
S1-02812774700	134	S1-A69	136	S1-AX54	139	S1-B77	138	S1-BX74	140
S1-02812775700	134	S1-A70	137	S1-AX55	139	S1-B78	138	S1-BX75	140
S1-02812776700	134	S1-A71	137	S1-AX56	139	S1-B79	138	S1-BX76	140
S1-02812777700	134	S1-A72	137	S1-AX57	139	S1-B80	138	S1-BX77	140
S1-02812780700	134	S1-A73	137	S1-AX58	139	S1-B81	138	S1-BX78	140
S1-02812781700	135	S1-A74	137	S1-AX59	139	S1-B82	138	S1-BX79	140
S1-02812785700	135	S1-A75	137	S1-AX60	139	S1-B83	138	S1-BX80	140
S1-02813269000	133	S1-A76	137	S1-AX61	139	S1-B84	138	S1-BX81	140
S1-02813270000	133	S1-A77	137	S1-AX62	139	S1-B85	138	S1-BX82	140
S1-02813271000	133	S1-A78	137	S1-AX63	139	S1-B86	138	S1-BX83	140
S1-02813272000	133	S1-A79	137	S1-AX64	139	S1-B87	138	S1-BX84	140
S1-02813358000	133	S1-A80	137	S1-AX65	139	S1-B88	138	S1-BX85	140
S1-02813359000	133	S1-A81	137	S1-AX66	139	S1-B89	138	S1-BX86	140
S1-02813931000	130	S1-A82	137	S1-AX67	139	S1-B90	138	S1-BX87	140
S1-02814752000	135	S1-A83	137	S1-AX68	139	S1-B91	138	S1-BX88	141
S1-02814878000	131	S1-A84	137	S1-AX69	139	S1-B92	138	S1-BX89	141
S1-02815473000	131	S1-A85	137	S1-AX70	139	S1-B93	138	S1-BX90	141
S1-02815474000	131	S1-A86	137	S1-AX71	139	S1-B94	138	S1-BX91	141
S1-02815946000	133	S1-A87	137	S1-AX72	139	S1-B95	138	S1-BX92	141

TABLE OF CONTENTS

PART NUMBER INDEX

S1 PART NO	PAGE	S1 PART NO	PAGE	S1 PART NO	PAGE	S1 PART NO	PAGE	S1 PART NO	PAGE
S1-SV-502037	27	S1-ZDMB1224	91	S1-ZDMS1818	93	S1-ZDMS3624	94	S1-ZR57KCE-TFD-930	7
S1-SV-502038	27	S1-ZDMB1226	91	S1-ZDMS2008	93	S1-ZMS	89	S1-ZR57KCE-TFD-950	7
S1-SV-502040	27	S1-ZDMB1228	91	S1-ZDMS2010	93	S1-ZP20K5E-PFV-800	6	S1-ZR57KCE-TFE-830	7
S1-SV-502042	27	S1-ZDMB1230	91	S1-ZDMS2012	93	S1-ZP24K5E-PFV-800	6	S1-ZR57KCE-TFE-930	7
S1-SV-502044	27	S1-ZDMB1232	91	S1-ZDMS2014	93	S1-ZP31K5E-PFV-800	6	S1-ZR57KCE-TFE-950	7
S1-SV-502046	27	S1-ZDMB1234	91	S1-ZDMS2016	93	S1-ZP34K5E-PFV-800	6	S1-ZR61KCE-PFV-930	8
S1-SV-700468	19	S1-ZDMB1236	91	S1-ZDMS2018	93	S1-ZP36K5E-PFV-830	6	S1-ZR61KCE-PFV-950	7
S1-SV-953595	155	S1-ZDMB1416	91	S1-ZDMS2020	93	S1-ZP36K5E-TF5-830	6	S1-ZR61KCE-TF5-930	8
S1-T2404F	79	S1-ZDMB1418	91	S1-ZDMS2208	93	S1-ZP38K5E-PFV-800	6	S1-ZR61KCE-TF5-950	8
S1-T3501M	79	S1-ZDMB1420	91	S1-ZDMS2210	93	S1-ZP42K5E-PFV-800	6	S1-ZR61KCE-TFD-930	8
S1-T6753	79	S1-ZDMB1422	91	S1-ZDMS2212	93	S1-ZP42K5E-TF5-800	6	S1-ZR61KCE-TFD-950	8
S1-T7752	79	S1-ZDMB1424	91	S1-ZDMS2214	93	S1-ZP49K5E-PFV-800	6	S1-ZR61KCE-TFE-930	8
S1-TEAC1625	81	S1-ZDMB1426	91	S1-ZDMS2216	93	S1-ZP54K5E-PFV-800	6	S1-ZR68KCE-TF5-930	8
S1-TEAC2025	81	S1-ZDMB1428	91	S1-ZDMS2218	93	S1-ZP57K3E-PFV-930	6	S1-ZR68KCE-TF5-950	7
S1-TG-2000	86	S1-ZDMB1430	91	S1-ZDMS2220	93	S1-ZP57K3E-TF5-930	6	S1-ZR68KCE-TFD-930	8
S1-THEC11NS	14	S1-ZDMB1432	91	S1-ZDMS2222	93	S1-ZP57K3E-TFD-930	6	S1-ZR68KCE-TFE-930	7
S1-THEC11P5S	14	S1-ZDMB1434	91	S1-ZDMS2408	93	S1-ZP61K5E-PFV-800	6	S1-ZR68KCE-TFE-950	8
S1-THEH21NS	14	S1-ZDMB1436	91	S1-ZDMS2410	93	S1-ZP61K5E-TFD-800	6	S1-ZR72KCE-TF5-950	8
S1-THEH21P5S	14	S1-ZDMB1618	91	S1-ZDMS2412	93	S1-ZP61K5E-TF5-830	6	S1-ZR72KCE-TFD-930	8
S1-THELOCK	15	S1-ZDMB1620	91	S1-ZDMS2414	93	S1-ZP67KCE-TF5-950	6	S1-ZR72KCE-TFD-950	8
S1-THEPLATE	15	S1-ZDMB1622	92	S1-ZDMS2416	93	S1-ZP67KCE-TFD-950	6	S1-ZR72KCE-TFE-930	8
S1-TM11PAC16252	82	S1-ZDMB1624	92	S1-ZDMS2418	93	S1-ZP72KCE-TF5-950	6	S1-ZR72KCE-TF5-950	8
S1-TM11PAC20202	82	S1-ZDMB1626	92	S1-ZDMS2420	93	S1-ZP90KCE-TF5-950	6	S1-ZR84KCE-TF5-950	8
S1-TM11PAC20252	82	S1-ZDMB1628	92	S1-ZDMS2422	93	S1-ZP90KCE-TFD-950	6	S1-ZR84KCE-TFD-950	8
S1-TM13PAC16252	82	S1-ZDMB1630	92	S1-ZDMS2424	93	S1-ZP154KCE-TE5950	6	S1-ZR94KCE-TFE-950	8
S1-TM13PAC20202	82	S1-ZDMB1632	92	S1-ZDMS2608	93	S1-ZP154KCE-TED950	6	S1-ZR108KCE-TF5950	7
S1-TM13PAC20252	82	S1-ZDMB1634	92	S1-ZDMS2610	93	S1-ZP180KCE-TWC961	6	S1-ZR108KCE-TFE950	7
S1-T-PB-202-0	87	S1-ZDMB1636	92	S1-ZDMS2612	93	S1-ZP180KCE-TWD961	6	S1-ZR125KCE-TF7950	7
S1-T-PB-202-1	87	S1-ZDMB1820	92	S1-ZDMS2614	93	S1-ZP182KCE-TED950	6	S1-ZR125KCE-TFE950	7
S1-TRAC2000	82	S1-ZDMB1822	92	S1-ZDMS2616	93	S1-ZP385KCE-TED951	6	S1-ZR144KCE-TF5950	7
S1-TURBO200	115	S1-ZDMB1824	92	S1-ZDMS2618	93	S1-ZR16K5E-PFV-800	7	S1-ZR144KCE-TFE950	7
S1-TURBO200MINI	115	S1-ZDMB1826	92	S1-ZDMS2620	93	S1-ZR18K5E-PFV-800	7	S1-ZR190KCE-TED950	7
S1-TURBO200X	115	S1-ZDMB1828	92	S1-ZDMS2622	93	S1-ZR19M3E-TWD-922	7	S1-ZRT144KCE-TF7930	8
S1-UMSR-50	60	S1-ZDMB1830	92	S1-ZDMS2624	93	S1-ZR21K5E-PFV-800	7	S1-ZRT144KCE-TFD930	8
S1-UVLAMP36120	84	S1-ZDMB1832	92	S1-ZDMS2808	93	S1-ZR21K5E-TF5-800	7	S1-ZRT144KCE-TFE930	8
S1-UVLAMP36120HW	84	S1-ZDMB1834	92	S1-ZDMS2810	93	S1-ZR21K5E-TFD-800	7	S1-ZRT162KCE-TFD930	8
S1-UVLAMP50120	84	S1-ZDMB1836	92	S1-ZDMS2812	93	S1-ZR25K5E-PFV-800	7	S1-ZRT188KCE-TFE950	8
S1-V800A1088	29	S1-ZDMB2022	92	S1-ZDMS2814	93	S1-ZR25K5E-TF5-800	7	S1-ZRT250KCE-TFE950	8
S1-V8043A1029	54	S1-ZDMB2024	92	S1-ZDMS2816	93	S1-ZR25K5E-TFD-800	7	SINGLE STAGE 1	17
S1-VR8200A2124	29	S1-ZDMB2026	92	S1-ZDMS2818	93	S1-ZR28K5E-PFV-800	7	ZP20K5E-PFV-800	6
S1-VR8200A2132	29	S1-ZDMB2028	92	S1-ZDMS2820	93	S1-ZR28K5E-TF5-800	7	ZP24K5E-PFV-800	6
S1-VR8204C1019	30	S1-ZDMB2030	92	S1-ZDMS2822	93	S1-ZR28K5E-TFD-800	7	ZP31K5E-PFV-800	6
S1-VR8300A3500	30	S1-ZDMB2032	92	S1-ZDMS2824	93	S1-ZR32K5E-PFV-800	7	ZP34K5E-PFV-800	6
S1-VR8300A4508	30	S1-ZDMB2034	92	S1-ZDMS3008	93	S1-ZR32K5E-TF5-800	7	ZP38K5E-PFV-800	6
S1-VR8345M4302	31	S1-ZDMB2036	92	S1-ZDMS3010	93	S1-ZR32K5E-TFD-800	7	ZP42K5E-PFV-800	6
S1-Y8610U4001	40	S1-ZDMB2224	92	S1-ZDMS3012	93	S1-ZR32K5E-TFE-800	8	ZP49K5E-PFV-800	6
S1-ZDMB0810	91	S1-ZDMB2226	92	S1-ZDMS3014	93	S1-ZR34K5E-PFV-800	7	ZP54K5E-PFV-800	6
S1-ZDMB0812	91	S1-ZDMB2228	92	S1-ZDMS3016	93	S1-ZR38K5E-PFV-800	7		
S1-ZDMB0814	91	S1-ZDMB2230	92	S1-ZDMS3018	93	S1-ZR38K5E-TF5-800	8		
S1-ZDMB0816	91	S1-ZDMB2232	92	S1-ZDMS3020	93	S1-ZR38K5E-TFD-800	8		
S1-ZDMB0818	91	S1-ZDMB2234	92	S1-ZDMS3022	93	S1-ZR38K5E-TFE-800	8		
S1-ZDMB0820	91	S1-ZDMB2236	92	S1-ZDMS3024	93	S1-ZR42K5E-PFV-800	8		
S1-ZDMB0822	91	S1-ZDMB2426	92	S1-ZDMS3208	93	S1-ZR42K5E-TF5-800	8		
S1-ZDMB0824	91	S1-ZDMB2428	92	S1-ZDMS3210	93	S1-ZR42K5E-TFD-800	8		
S1-ZDMB0826	91	S1-ZDMB2430	92	S1-ZDMS3212	93	S1-ZR42K5E-TFE-800	8		
S1-ZDMB0828	91	S1-ZDMB2432	92	S1-ZDMS3214	93	S1-ZR48K5E-PFV-800	8		
S1-ZDMB0830	91	S1-ZDMB2434	92	S1-ZDMS3216	93	S1-ZR48K5E-TF5-800	8		
S1-ZDMB0832	91	S1-ZDMB2436	92	S1-ZDMS3218	93	S1-ZR48K5E-TFD-800	8		
S1-ZDMB0834	91	S1-ZDMS0808	92	S1-ZDMS3220	93	S1-ZR48K5E-TFE-800	8		
S1-ZDMB0836	91	S1-ZDMS1008	92	S1-ZDMS3222	93	S1-ZR54K5E-TF5-800	8		
S1-ZDMB1012	91	S1-ZDMS1010	92	S1-ZDMS3224	93	S1-ZR54K5E-TFD-800	8		
S1-ZDMB1014	91	S1-ZDMS1208	92	S1-ZDMS3408	93	S1-ZR54K5E-TFE-800	8		
S1-ZDMB1016	91	S1-ZDMS1210	92	S1-ZDMS3410	93	S1-ZR57K3E-PFV-830	7		
S1-ZDMB1018	91	S1-ZDMS1212	92	S1-ZDMS3412	93	S1-ZR57K3E-PFV-930	7		
S1-ZDMB1020	91	S1-ZDMS1408	92	S1-ZDMS3414	93	S1-ZR57K3E-PFV-950	7		
S1-ZDMB1022	91	S1-ZDMS1410	92	S1-ZDMS3416	93	S1-ZR57K3E-TF5-830	7		
S1-ZDMB1024	91	S1-ZDMS1412	92	S1-ZDMS3418	93	S1-ZR57K3E-TF5-930	7		
S1-ZDMB1026	91	S1-ZDMS1414	92	S1-ZDMS3420	93	S1-ZR57K3E-TF5-950	7		
S1-ZDMB1028	91	S1-ZDMS1608	92	S1-ZDMS3422	93	S1-ZR57K3E-TFD-830	7		
S1-ZDMB1030	91	S1-ZDMS1610	92	S1-ZDMS3424	93	S1-ZR57K3E-TFD-930	7		
S1-ZDMB1032	91	S1-ZDMS1612	92	S1-ZDMS3608	93	S1-ZR57K3E-TFD-950	7		
S1-ZDMB1034	91	S1-ZDMS1614	93	S1-ZDMS3610	93	S1-ZR57K3E-TFE-830	7		
S1-ZDMB1036	91	S1-ZDMS1616	93	S1-ZDMS3612	94	S1-ZR57K3E-TFE-930	7		
S1-ZDMB1214	91	S1-ZDMS1808	93	S1-ZDMS3614	94	S1-ZR57K3E-TFE-950	7		
S1-ZDMB1216	91	S1-ZDMS1810	93	S1-ZDMS3616	94	S1-ZR57KCE-TF5-830	8		
S1-ZDMB1218	91	S1-ZDMS1812	93	S1-ZDMS3618	94	S1-ZR57KCE-TF5-930	7		
S1-ZDMB1220	91	S1-ZDMS1814	93	S1-ZDMS3620	94	S1-ZR57KCE-TF5-950	7		
S1-ZDMB1222	91	S1-ZDMS1816	93	S1-ZDMS3622	94	S1-ZR57KCE-TFD-830	7		



Genuine parts. Genuine performance. Genuine service.

Genuine Parts – it's about the best fix. Using Johnson Controls genuine parts in JCI Ducted Systems branded equipment ensures you a faster first time fix with an original quality part.

For all other equipment, use our SOURCE 1[®] aftermarket line of products.

Better for you, your customer,
and their equipment.



**Genuine parts.
Genuine performance.
Genuine service.**

Genuine Parts - it's about the best fix. Using Johnson Controls genuine parts in JCI Ducted Systems branded equipment ensures you a faster first time fix with an original quality part.

For all other equipment, use our SOURCE 1[®] aftermarket line of products.

Better for you, your customer, and their equipment.

